

---

International conference on Life Cycle Assessment  
as reference methodology for assessing supply chains  
and supporting global sustainability challenges

**LCA FOR “FEEDING THE PLANET  
AND ENERGY FOR LIFE”**

Stresa, 6-7<sup>th</sup> October 2015  
Milano, Expo 2015, 8<sup>th</sup> October 2015

---

Edited by Simona Scalbi, Arianna Dominici Loprieno, Paola Sposato



MILANO 2015



Italian National Agency for New Technologies,  
Energy and Sustainable Economic Development



International conference on Life Cycle Assessment as reference methodology for assessing supply chains and supporting global sustainability challenges

LCA FOR “FEEDING THE PLANET AND ENERGY FOR LIFE”

Stresa, 06-07<sup>th</sup> October 2015 - Milano, Expo 2015, 08<sup>th</sup> October 2015

*Edited by Simona Scalbi, Arianna Dominici Loprieno, Paola Sposato*

2015 ENEA  
Italian National Agency for New Technologies, Energy and  
Sustainable Economic Development

Lungotevere Thaon di Revel, 76  
00196 Roma

ISBN 978-88-8286-321-0

## Index

<b>Introduction - Life cycle assessment for supporting the transition towards eco-efficient agriculture and food systems .....</b>	<b>9</b>
<b>Conference program .....</b>	<b>11</b>
<b>Consumption trends and sustainability of future development .....</b>	<b>16</b>
Tomorrow's healthy Society: research priorities for foods and diets .....	17
Environmental Impact of the European Food Basket using LCA .....	21
Environmental Implications of Dynamic Policies on Food Consumption and Waste Handling in the European Union .....	25
How much meat can we eat to sustain a healthy life and planet? The case of Swedish meat consumption .....	29
Carbon footprint of Italian eating habits: how consumer food choices might lead to a reduction of greenhouse gas emissions.....	36
<b>Product Environmental Footprint in the food sector .....</b>	<b>40</b>
Developing Product Environmental Footprint Category Rules for Olive Oil .....	41
Pesticide emissions in the Environmental Product Footprint – Lessons learnt from refined sugar from sugar beet .....	45
Five crucial complicating issues for harmonising environmental footprints of food and beverages .....	49
Environmental impacts of different dairy farming systems in the Po Valley.....	53
The Product Environmental Footprint Category Rules (PEFCR) Packed Water Pilot Testing .....	58
Identification of the most relevant impact categories with normalisation and equal weighting methods: inconsistencies found in raw milk case study .....	61
<b>Inventories and dabase for LCA and footprint of food chains.....</b>	<b>65</b>
Life Cycle Inventory database for seafood products.....	66
The World Food LCA Database: a global inventory database for the food sector .....	70
Creating coherent life cycle databases for ecodesign and product declaration of agro-industrial products: how to implement methodological choices .....	74
Wheat of today and tomorrow: an assessment of current LCI inventories .....	80
Food PEFCRs and the need for consistent secondary databases such as Agri-footprint® .....	84
<b>LCA and footprints to asses food product chains.....</b>	<b>88</b>
Energy Use in the EU Food Sector: State of Play and Opportunities for Improvement .....	89
Energy Flows and Greenhouses Gases of EU national breads using LCA approach.....	94
Life Cycle Assessment for Enhancing Environmental Sustainability of Sugarcane Biorefinery in Thailand .....	98
Life Cycle Assessment of Biogas Production from Marine Macroalgal Feedstock: Substitution of Energy Crops with Algae .....	102
Environmental assessment of wheat and maize production in an Italian farmers cooperative .....	106

Protein quality as functional unit – a methodological framework for inclusion in Life Cycle Analysis (LCA) .....	110
LCA as a decision support tool in policy making: the case study of Danish spring barley production in a changed climate .....	114
Mediterranean countries’ food supply and food sourcing profiles:.....	118
An Ecological Footprint viewpoint .....	118
Simplified modelling of environmental impacts of foods .....	122
Life Cycle Assessment of Thai Organic Rice to Evaluate the Climate Change, Water Use and Biodiversity Impacts.....	126
Comparative LCA study on environmental impact of oil production from microalgae and terrestrial oilseed crops.....	130
Liquid whey recycling within the traditional dairy chain, as a sustainable alternative for whey waste management.....	134
Quantification of life cycle energy use for a more efficient building design. ....	139
Resource footprint of Vietnamese Pangasius frozen fillets and export to the European market .....	143
Comparative LCA of bread baked in novel Low Energy Ovens and conventional ovens .....	147
Life Cycle Assessment of the production and import of Arabica Brazilian coffee.....	151
The link between CSR, EMS and LCA with coffee as an example .....	155
Sustainability and performance design of open loop recycling strategies in the production of innovative building materials .....	159
A tool for the sustainability assessment of transformation activities of buildings .....	163
LCA of clean technologies in food value chains of emerging economies .....	167
Life Cycle Assessment of Food Smoking Technologies.....	171
Low Emission Farming – a significant step forward to improve the environmental impacts of livestock production .....	175
Energy and water savings by exploiting nano-technological self cleaning textiles .....	182
Selecting an appropriate fuel mix in LCA of energy savings .....	186
Assessing the impacts of onshore wind energy by using a spatio-temporal LCA approach.....	190
Life Cycle Assessment of Palm Biodiesel Production in Thailand: Impacts from Improvement Technologies, Land Use Changes and Modelling Choices .....	194
Energy recovery from garden waste in a LCA perspective.....	198
Comparing Water Footprint impact methods: a case study on biogas production from energy crops.....	202
Environmental assessment of electricity generation from anaerobic digestion of agricultural waste.....	206
LCA and Water Footprint of biofuels used in transport sector: a review .....	232
Simplified LCA tools: selected approaches assessed for their implementation in the agri-food sector....	214
“Vernaccia di San Gimignano DOCG”: towards a sustainable wine farming .....	218
Environmental impacts of the brewing sector: Life Cycle Assessment of Italian craft and industrial beer.....	222
LCA-LCC decision tool for energy generation technologies in a food processing plant.....	226
Life Cycle Assessment of Oilseed Canola Production in Iranian Agriculture .....	230



Carbon footprint assessment of rapeseed in an intensive, conventional production system in the Wielkopolska region (Poland).....	234
The ecological footprint of products of oil palm and rubber plantations in Thailand.....	238
Comparative LCA of sunflower, rapeseed and soybean oils .....	242
Life Cycle Assessment of organic apple supply chain in the North of Italy .....	246
Environmental assessment of rice cultivation: a case study of fertilisation with urban sewage .....	250
Life Cycle Assessment of Greenhouse-Grown Tomatoes in Thailand .....	254
The evolution of LCA in milk production .....	258
Dairy products: Energy use and the associated greenhouse gas emissions.....	262
Carbon footprint analysis of mozzarella and ricotta cheese production and influence of allocation procedure .....	266
Global warming potential of Lombardy cow milk production at farm .....	270
Life cycle assessment of sugar production in Hamadan sugar mill .....	274
Sustainability in breeding farms: the case of the Maremmana beef.....	278
Carbon Footprint of tropical Amazon fruit jam from agroforestry .....	282
Life-cycle assessment of chestnut produced in the north of Portugal.....	286
<b>Life Cycle Impact Assessment: needs and challenges for assessing food supply chains .....</b>	<b>290</b>
Pesticide Substitution: Combining Food Safety with Environmental Quality.....	291
Building consensus for assessing land use impacts on biodiversity: contribution of UNEP/SETAC's Life Cycle Initiative .....	294
Coupling land use information with remotely sensed spectral heterogeneity: a new challenge for life cycle impact assessment of plant species diversity.....	298
Biodiversity impact: Case study beef production.....	302
Pollinators in LCA: towards a framework for impact assessment .....	307
Evaluating use stage exposure to food contact materials in a LCA framework.....	311
Assessing freshwater biodiversity as endpoint modeling of impacts in LCIA: case of run-of-river hydropower .....	315
Spatial and temporal assessment of GHG emissions from cocoa farming in the region of San Martin, Peru .....	319
Land use in life cycle impact assessment: a review of models at midpoint level to incorporate impacts on soil state and functioning.....	323
Marine eutrophication impacts from present and future production of spring barley.....	327
Integration of Land Use aspects in LCA: determination of land use types as a crucial factor influencing the result.....	331
Ecocentric Water Scarcity Index to address local and temporal climate variability: the case of a tomato sauce.....	335

<b>Eco-innovation and industrial symbiosis in the food sector .....</b>	<b>339</b>
Environmental assessment of Ultra-High Pressure Homogenisation for milk and fresh cheese production.....	340
Strategies for reducing food waste: Life Cycle Assessment of a pilot plant for insect-based feed products .....	344
Environmental Impact Assessment of caproic acid production from organic waste: A case study of a novel pilot-scale biorefinery in the Netherlands .....	348
Recovery of waste streams from agroindustry through industrial symbiosis in Sicilia .....	352
Environmental impact of using specialty feed ingredients in pig and broiler production: A life cycle assessment .....	356
Alternative scenarios of food-waste treatment: a comparative Life Cycle Assessment.....	360
Sustainable Management of EU Food Waste with Life Cycle Assessment.....	364
How food loss is addressed in LCA.....	368
Challenges and opportunities in using Life Cycle Assessment and Cradle to Cradle® for biodegradable bio-based polymers: a review .....	372
The Hamlet dilemma for aluminium cans in the circular economy: to be or not to be in a closed loop?.	376
<b>Sustainability assessment of food supply chains: socio-economics drivers and impacts .....</b>	<b>380</b>
In food supply chain: social LCA, what to do?.....	"381
Food redistribution in the Helsinki Metropolitan and Turku Areas .....	387
Integrating LCA within MuSIASEM approach to evaluate feasibility, viability and desirability of second generation bioethanol from <i>Arundo donax</i> feedstock for transportation energy needs of Campania (Italy). .....	389
Combining frontier analysis and Exergetic Life Cycle Assessment towards identification of economic-environmental win-win situations on dairy farms .....	392
Life cycle social sustainability assessment convenience food: Ready-made meals.....	396
LCC, S-LCA and LCSA in food and energy sectors: lessons from scientific literature .....	401
Applying Social Life Cycle Assessment in the Thai Context: Challenges from the sugar industry .....	405
Material Flow and Water Footprint Analysis of Cassava Starch Production Systems .....	409
Traditional cultivars, improved performance: reflections on the climate change intensity of traditional foods .....	413
Social LCA: a framework for social impacts assessment in Italian wine sector.....	417
Social Life Cycle Assessment in the honey industry .....	421
Environmental and social impact indicators of soil consumption.....	425
Tools to improve the energy efficiency of the institutional food system .....	430
Acknowledgements	435

## **SCIENTIFIC COMMITTEE**

Assumpció Antón Vallejo – Institute for Food and Agricultural Research and Technology (IRTA),  
Barcelona, Spain

Maurizio Cellura – University of Palermo, Italy

Camillo De Camillis - FAO, Roma

Vito D'Incognito – Take Care International, Milan, Italy

Ulrike Eberle – Private Universität Witten/Herdecke, Zentrum für Nachhaltige Unternehmensführung,  
Germany

Peter Fantke – Technical University of Denmark (DTU), Quantitative Sustainability Assessment, Denmark

Chris Foster – EuGeos Limited, United Kingdom

Pierre Gerber – Food and Agriculture Organization of the United Nations – FAO

Monica Lavagna – Politecnico di Milano, Italy

Adrian Leip – European Commission Joint Research Centre, Institute for Environment and Sustainability

Catherine Macombe – Irstea UMR ITAP-ELSA, Montpellier, France

Paolo Masoni – Italian National Agency for New Technologies, Energy and Sustainable Economic  
Development (ENEA), Bologna, Italy

Sarah McLaren – Massey University

Llorenç Milà i Canals – United Nations Environment Programme (UNEP)

Bruno Notarnicola – University of Bari, Italy

Carolyn Opio - FAO, Roma

Andrea Raggi – University “G. d’Annunzio”, Pescara, Italy

Serena Righi – University of Bologna, Italy

Serenella Sala – European Commission Joint Research Centre, Institute for Environment and Sustainability

Roberta Salomone – University of Messina, Italy

Erwan Saouter – European Commission Joint Research Centre, Institute for Environment and Sustainability

Simona Scalbi - Italian National Agency for New Technologies, Energy and Sustainable Economic  
Development (ENEA), Bologna, Italy

Antonio Scipioni – University of Padova, Italy

Rita Schenck - Institute for Environmental Research and Education (IERE), US

Rogier Schulte - Livestock Environmental Assessment and Performance (LEAP) Partnership and Teagasc  
Ireland

Ulf Sonesson – SP Technical Research Institute of Sweden

Stefan Storcksdieck genannt Bonsmann – European Commission Joint Research Centre, Institute for Health  
and Consumer Protection

Hayo van der Werf- Institut National de la Recherche Agronomique (INRA), Rennes, France

## **ORGANISING COMMITTEE**

Serenella Sala - European Commission, Joint Research Centre

Monica Lavagna - Rete Italiana LCA, Politecnico di Milano

Valentina Castellani - European Commission, Joint Research Centre

Arianna Dominici Loprieno - Rete Italiana LCA, ENEA

Sara Ganassali - Rete Italiana LCA, Politecnico di Milano

Alberto Prinzo - Rete Italiana LCA, Politecnico di Milano

## **Introduction**

### **Life cycle assessment for supporting the transition towards eco-efficient agriculture and food systems**

The Universal Exposition EXPO 2015 in Italy had as central theme “Feeding the Planet, Energy for Life”, one of the major sustainability challenge for the future. Ensuring sustainable human development means being able to feed a planet with increasing population, decoupling the development from environmental impact and answering the evolving energy demand. Nowadays, Food and Energy supply chains are associated with complex and intertwined environmental and socio-economic impacts.

The identification of solutions towards sustainability in the food and energy sectors need to rely on integrated appraisal methodologies for comparing possible alternatives, avoiding burden shifting geographically, temporally and along supply chains.

Therefore, Life cycle assessment (LCA) represents a reference methodology that helps analyzing supply chains toward achieving sustainability objectives, including improved agriculture, food production and consumption as well as more efficient energy conversion and use.

The Italian LCA network and the Joint Research Centre of the European Commission jointly organize a conference during EXPO 2015, discussing the role of LCA on the EXPO 2015 topics and presenting latest research in the field.

The studies presented in the conference, reported in these proceedings, demonstrate the relevance of Life cycle thinking and assessment as key elements towards sustainable solutions and ecoinnovation for global food challenges. An increasing global population, an evolution in consumers’ needs and the changes in consumption models pose serious challenges to the overall sustainability of food production and consumption. In defining solutions to major global challenges, life cycle thinking and life cycle assessment are applied for : i) the identification of hotspots of impacts along food supply chain with a focus on major global challenges; ii) the comparison of options related to food supply chain optimizations (increase of productivity, reduction of food losses, etc) towards sustainable solutions; iii) assessment of future scenarios both related to technological improvement, behavioral changes and under different environmental conditions (e.g. climate change); iv) assessment of social impacts associated to consumption patterns.

Analyzing these challenges from a global/ continental perspectives, major improvements are needed both in life cycle inventories - related to data availability, quality and representativeness-, and in life cycle impact assessment– where the enhancement of impact modeling for water, land use, resource and toxicity are fundamental for robust assessment of alternatives.

Due to the variety of challenges and perspectives, several methodologies are needed to answer different sustainability questions. For example, exploring concepts such as “water food energy nexus”, in light of promoting circular economy, means to optimize production of food and energy on one hand and to reduce (food)waste on the other hand. This requires a transition towards systemic thinking, where impacts of global production and consumption patterns remain within the carrying capacity of the planet, namely the sustainability thresholds identified as planetary boundaries.

This systemic thinking entails the identification of complementarity amongst methodologies and the critical analysis of their pros and cons for supporting decision making.

We hope that the concepts and the case studies presented at the conference and in these proceedings could further support cross fertilization among different science domains (such as technological, environmental, social and economic ones) towards a sustainable “today and tomorrow” in feeding the planet.

**Serenella Sala and Paolo Masoni**

## Conference program

6th OCTOBER 2015

Stresa, Grand Hotel Bristol

- 08:15 - Registration
- 08:45 - Welcome  
Serenella Sala (*European Commission, Joint Research Centre, IES*) and Paolo Masoni (*Rete Italiana LCA and ENEA*)
- 09:00 - **LCA as methodology for Better Regulation**  
Constantin Ciupagea (*European Commission, Joint Research Centre, IES*)
- 09:15 - **Towards eco-efficient agriculture and food system: the special issue of the journal of cleaner production (JCP)**  
Donald Huising (*editor in chief JCP*)

### Session 1.1 Consumption trends and sustainability of future development

Chairs: Erwan Saouter and Constantin Ciupagea

- 09:30 - **The European State and Outlook 2015 - Key findings related to the food supply chain**  
Ybele Hoogeveen (*European Environment Agency*)
- 09:45 - **Tomorrow's healthy Society: research priorities for foods and diets**  
Sandra Caldeira (*European Commission, Joint Research Center, IHCP*)
- 10:00 - **Framing the role of LCA in integrated assessment tools for transition to sustainable food and agriculture: the case of livestock supply chains**  
Camillo De Camillis (*Food and Agriculture Organization of the United Nations*)
- 10:15 - **Environmental Impact of the European Food Basket using LCA**  
Serenella Sala (*European Commission, Joint Research Center, IES*)
- 10:30 - **Environmental Implications of Dynamic Policies on Food Consumption and Waste Handling in the European Union**  
Michael Martin (*IVL-Swedish Environmental Research Institute*)
- 10:45 - **Discussion**
- 11:00 *Coffee Break and Poster Session*

### Session 1.2. Product Environmental Footprint in the food sector

Chairs: Bruno Notarnicola and Hayo Van der Werf

- 11:20 - **ENVIFOOD Protocol: Facilitating consumer choice for more sustainable products** Erwan Saouter (*European Commission, Joint Research Center, IES*)
- 11:35 - **Developing Product Environmental Footprint Category Rules for Olive Oil**  
Hanna Tuomisto (*European Commission, Joint Research Centre, IES*)
- 11:50 - **Pesticide emissions in the Environmental Product Footprint – Lessons learnt from refined sugar from sugar beet**  
Alessandra Zamagni (*Ecoinnovazione*)
- 12:05 - **Nestlé Ecodesign Tool: Recent Developments that can contribute to improving the Product Environmental Footprint Initiative**  
Urs Schenker (*Nestlé Research Center*)
- 12:20 - **Five crucial complicating issues for harmonising environmental footprints of food and beverage**  
Tommie Ponsioen (*PRé Consultants*)
- 12:35 - **Environmental impacts of different dairy farming systems in the Po Valley**  
Alessandro Agostini (*European Commission, Joint Research Center, IET*)

- 12:50 - **Discussion**
- 13:00 - *Lunch and Poster Session*

### **Session 1.3. Inventories and database for LCA and footprints of food chains**

Chairs: Paolo Masoni and Ulf Sonesson

- 14:30 - **Life Cycle Inventory database for seafood products**  
Sophie Omont (*CYCLECO Bureau d'études*)
- 14:45 - **Towards the Global Reference for Feed LCA data: the Global Feed LCA Institute**  
Nicolas Martin (*European Feed Manufacturers' Federation*)
- 15:00 - **The World Food LCA Database: a global inventory database for the food sector**  
Simone Pedrazzini (*Quantis*)
- 15:15 - **Creating coherent life cycle databases for ecodesign and product declaration of agro-industrial products: how to implement methodological choices**  
Patrik Mouron (*Agroscope*)
- 15:30 - **Wheat of today and tomorrow: an assessment of current LCI inventories**  
Sara Corrado (*Agrisystem UCSC*)
- 15:45 - **Discussion**
- 16:05 - *Coffee break and Poster Session*

### **Session 1.4. LCA and footprints to assess food production chains**

Chairs: Vito D'Incognito and Urs Schenker

- 16:25 - **Mediterranean countries' food supply and food sourcing profiles: an Ecological Footprint viewpoint**  
Alessandro Galli (*Global Footprint Network*)
- 16:40 - **Energy Use in the EU Food Sector: State of Play and Opportunities for Improvement**  
Fabio Monforti Ferrario (*European Commission, Joint Research Center, IET*)
- 16:55 - **Energy Flows and Greenhouses Gases of EU national breads using LCA approach**  
Bruno Notarnicola (*University of Bari*)
- 17:10 - **Life Cycle Assessment for Enhancing Environmental Sustainability of Sugarcane Biorefinery in Thailand**  
Thapat Silalertruksa (*Joint Graduate School of Energy and Environment, King Mongkut's University of Technology Thonburi*)
- 17:25 - **Coupling LCA with forest and geographical information system models for bioenergy: a Norwegian case study**  
Clara Valente (*Ostfold Research AS*)
- 17:40 - **Discussion**
- 18:00 - **Meeting Association Italian LCA Network**
- 20:30 - **Social Dinner**

**7th OCTOBER 2015**

*Stresa, Grand Hotel Bristol*

- 08:15 - Registration



## Session 2.1. LCA and footprints to assess food production chains

Chairs: Adrian Leip and Peter Fantke

- 08:40 - **Environmental assessment of wheat and maize production in an Italian farmers cooperative**  
Valentina Fantin (*Agenzia nazionale per le nuove tecnologie, l'energia e lo sviluppo economico sostenibile*)
- 08:55 - **Protein quality as functional unit – a methodological framework for inclusion in LCA**  
Ulf Sonesson (*SP Technical Research Institute of Sweden*)
- 09:10 - **LCA as a decision support tool in policy making: a case study of Danish spring barley production in a changed climate**  
Monia Niero (*Technical University of Denmark*)
- 09:25 - **Life Cycle Assessment of Biogas Production from Freshwater Macro-algal Feedstock: Substitution of Energy Crops with Algae**  
Funda Cansu Ertem (*Technische Universität Berlin*)
- 09:40 - **Simplified modelling of environmental impacts of foods**  
Hayo van der Werf (*Institut national de la recherche agronomique*)
- 09:55 - **Life Cycle Assessment of Organic Rice Farming in Thailand to Support Policy Decision on Sustainable Agriculture**  
Rattanawan Mungkung (*Kasetsart University*)
- 10:10 - **Discussion**
- 10:30 - *Coffee break and Poster Session*

## Session 2.2. Life Cycle Impact Assessment: needs and challenges for assessing food supply chains

Chairs: Serenella Sala and Assumpció Antón Vallejo

- 10:50 - **Pesticide Substitution: Combining Food Safety with Environmental Quality**  
Peter Fantke (*Technical University of Denmark*)
- 11:05 - **Outcome of WULCA harmonization activities: recommended characterization factors for water footprinting**  
Stephan Pfister (*Swiss Federal Institute of Technology Zurich*)
- 11:20 - **Building consensus for assessing land use impacts on biodiversity: contribution of UNEP/SETAC's Life Cycle Initiative**  
Assumpció Antón Vallejo (*Research & Technology Food & Agriculture*)
- 11:35 - **Coupling land use information with remotely sensed spectral heterogeneity: a new challenge for life cycle impact assessment of species diversity**  
Benedetto Rugani (*Luxembourg Institute of Science and Technology*)
- 11:50 - **Biodiversity impact: Case study beef production**  
Ulrike Eberle (*Private Universität Witten/Herdecke*)
- 12:05 - **Pollinators in LCA: towards a framework for impact assessment**  
Eleonora Crenna (*University of Milano - Bicocca*)
- 12:20 - **Discussion**
- 12:40 - *Lunch and Poster Session*

### Session 2.3. Eco-innovation and industrial symbiosis in the food sector

Chairs: Maurizio Cellura and Chris Foster

- 14:00 - **Lost water and nitrogen resources due to EU consumer food waste**  
Adrian Leip (*European Commission, Joint Research Center, IES*)
- 14:15 - **Sustainability assessment of ultra-high pressure homogenisation for milk and fresh cheese production: from pilot to industrial scale**  
Lucia Valsasina (*Aalborg University and German Institute of Food*)
- 14:30 - **Strategies for reducing food-waste: Life Cycle Assessment of a pilot plant of insect-based feed products**  
Roberta Salomone (*University of Messina*)
- 14:45 - **Environmental Impact Assessment of caproic acid production from food waste: A case study of a novel pilot-scale biorefinery in the Netherlands**  
Wei-Shan Chen (*Wageningen University*)
- 15:00 - **Recovery of waste streams from agroindustry through industrial symbiosis in Sicilia**  
Grazia Barberio (*Agenzia nazionale per le nuove tecnologie, l'energia e lo sviluppo economico sostenibile*)
- 15:15 - **Environmental impact of using specialty feed ingredients in pig and broiler production: A life cycle assessment**  
Alexander Liedke (*Thinkstep AG*)
- 15:30 - **Discussion**
- 15:50 - *Coffee break and Poster Session*

### Session 2.4. Sustainability assessment of food supply chain: socio-economic drivers and impacts

Chairs: Sarah McLaren and Ulrike Eberle

- 16:10 - **In food supply chain: social LCA, what to do?**  
Catherine Macombe (*Institut national de recherche en sciences et technologies pour l'environnement et l'agriculture*)
- 16:40 - **Food redistribution in Helsinki Metropolitan and Turku Area**  
Kirsi Silvennoinen (*Natural Resource Institute Finland*)
- 16:55 - **An integrated LCA study to evaluate feasibility, viability and desirability of bioethanol from giant reed crop for transport in Campania Region, Italy**  
Angelo Fierro (*University Federico II of Napoli*)
- 17:10 - **Combining frontier analysis and Exergetic Life Cycle Assessment towards identification of economic-environmental win-win situations on dairy farms**  
Sophie Huysveld (*Ghent University - Institute for Agricultural and Fisheries Research*)
- 17:25 - **Life cycle sustainability assessment of consumption and production of ready-made meals**  
Adisa Azapagic (*University of Manchester*)
- 17:40 - **LCC, S-LCA and LCSA in food and energy sectors: lessons from scientific literature**  
Andrea Fedele (*University of Padova*)

**8th OCTOBER 2015**

*Expo 2015 Site, EU Pavilion, Rho*

10:45 - Registration

**Roundtable “LCA for feeding the planet, energy for life”**

Chairs: Paolo Masoni and Serenella Sala

11:00 - **Roundtable Discussion:**

Giovanni Brunelli (*Italian representative Ministry of Environment*)

David Wilkinson (*Director of Institute for Environment and Sustainability, European Commission, JRC*)

Tassos Haniotis (*European Commission-DG AGRI*)

Michele Galatola (*European Commission-DG ENV*)

Ybele Hoogeveen (*European Environment Agency*)

Llorenç Milà i Canals (*United Nations Environment Programme*)

Camillo De Camillis (*Food and Agriculture Organization of the United Nations*)

12:20 - **Open Discussion**



# Consumption trends and sustainability of future development



## Tomorrow's healthy Society: research priorities for foods and diets

Anne-Katrin Bock <sup>a</sup>, Petros Maragkoudakis <sup>b</sup>, Jan Wollgast <sup>b</sup>, Sandra Caldeira <sup>1b</sup>,  
Agnes Czimbalmos <sup>a</sup>, Malgorzata Rzychon <sup>c</sup>, Bela Atzel <sup>a</sup>, Franz Ulberth <sup>c</sup>

<sup>1</sup>Presenting author

<sup>a</sup> European Commission, Joint Research Centre HQ, Rue du Champ de Mars 21, 1050 Brussels, Belgium

<sup>b</sup> European Commission, Joint Research Centre, Institute for Health and Consumer Protection,  
via E. Fermi 2749, Ispra 21027 (VA), Italy

<sup>c</sup> European Commission, Joint Research Centre, Institute for Reference Materials and Measurements,  
Retieseweg 111, 2440 Geel, Belgium

E-mail contact: [sandra.caldeira@ec.europa.eu](mailto:sandra.caldeira@ec.europa.eu)

### 1. Abstract

*Health promotion and disease prevention are increasingly recognised as crucial efforts to address Europe's Health challenges. Unhealthy diets are a major risk factor for many non-communicable disease, hence disease prevention through healthier eating habits could alleviate the high individual and societal costs of illness. Ensuring a healthier future requires renewed commitments and research. The JRC has conducted a foresight study using an exploratory, scenario-building approach with the year 2050 as a time horizon. Four different future scenarios were developed and provided the basis for the identification of future challenges and opportunities in food and health and the research needed to address them. The study identifies ten research priority areas and emphasises the need for a systems approach in addressing healthy and sustainable diets.*

### 2. Introduction

Health promotion and disease prevention are crucial, both socially and economically, in the face of strained healthcare systems, an ageing population, and the high individual and public costs of disease. This applies in particular for non-communicable diseases (NCDs), such as diabetes, cardiovascular diseases or cancer [1]. One of the four major risk factors for NCDs is an unhealthy diet, making better nutrition and eating habits a potentially effective and cost-efficient prevention strategy. The provision and consumption of healthy diets relies on the whole food chain and the consumer itself, and is interlinked with many other areas such as healthcare, the economy, environment, lifestyles, etc. Research plays an essential role in that it increases our understanding of; i) nutrition needs; ii) impact of diets on health; iii) disease mechanisms; or iv) determinants of consumer choice. It also paves the ground for: the development of improved or novel food products and production technologies; ensuring environmental sustainability of diets; or financial sustainability of agriculture and trade. These are just a few of the areas relevant in this context. The Foresight study 'Tomorrow's healthy society – research priorities for foods and diets', carried out by the European Commission's Joint Research Centre, was initiated at the request of the Directorate-General for Research and Innovation to inform the prioritisation of research areas to be funded by the Horizon 2020 programme [2]. The exploratory scenarios focused on the European consumer with 2050 as a time horizon.

The participatory approach involved around 40 experts and stakeholders with a broad range of backgrounds in three workshops held in 2012 and 2013.



Four different future scenarios were developed using the extremes of two main drivers – agricultural commodity prices (low or high) and societal values (community spirit or individualistic society). The challenges and opportunities arising from the different scenarios helped identify and prioritise corresponding research needs. The resulting ten research priorities fall into four thematic areas which are presented below. Life cycle analysis and its community can contribute to such research in particular in the development of pertinent methodologies and a solid food system framework.

## **2. Towards healthier eating: integrated policy-making**

### *2.1. Improve the evidence base for adoption of healthier dietary behavior.*

Strong evidence base for the development of authoritative, EU-wide (and internationally) agreed dietary reference values, and the definition of healthy dietary patterns is needed to increase the consensus on policy targets for healthy eating. Science-based tools and methods are needed to translate the scientific evidence base into food-based dietary guidelines that are easy to understand, take up and adapt.

### *2.2 Develop a scientific framework for a systems approach to food and nutrition policies*

This should include science-based, user-friendly tools to describe the food system and its key interactions as a whole; a framework to enable systems thinking in terms of research and policy design and decision-making; effective systems solutions to nutrition and health issues, and effective ways to network policies and promote coherence across policies and relevant actors, reflecting a dynamic society and industry landscape.

### *2.3 Provide a framework to design, monitor and evaluate policies*

This should be accomplished through a science-based methodological framework for the systematic *ex-ante* and *ex-post* impact assessment of policies; the identification of effective policy measures enabling healthy and nutritionally balanced diets, including population-specific measures; and the development of tools for monitoring and the timely identification and assessment of relevant food-chain developments.

## **3. Food, nutrients and health: cross-interactions and emerging risks**

### *3.1. Deepening the understanding of human nutrition: facing the complexities*

This includes the development of improved and nutrition-tailored study designs for better research approaches, better integration of knowledge from different, relevant disciplines, and elucidation of the complex interaction between genes, diets, behaviour, the environment and other determinants of individual health status.

### *3.2 Anticipation of emerging risks*

This is achieved through the development of an integrated anticipatory approach that entails indicators for the early identification of potentially acute food safety risks; a systems understanding of the long-term physiological effects of novel dietary components and changed consumption patterns; and a resilient strategy to ensure food safety in a globalised complex food chain.

## **4. Making individualised diets a reality**

### *4.1 Data needs: creation and management of necessary data for enabling individualised diets*

This includes identification of the types of data needed and the specific technical requirements and appropriate methodologies for their collection, processing and translation into individualised dietary advice. In addition, effective approaches are needed to make this advice easily accessible and understandable for consumers, supporting adherence to such dietary advice. The development of guidelines and quality standards to ensure high-quality, reliable and evidence-based services; measures and procedures to deal with ethical and legal issues are also needed.

### *4.2 Analysing the feasibility and impacts of individualised, healthy diets*

This is done through: risk/benefit assessment and cost-effectiveness analysis of the implementation of individualised dietary advice regarding individual health status and the healthcare system; identification of the required level of consumer health and nutrition literacy and of drivers affecting consumer acceptance and adherence to individualised dietary advice, paying particular attention to specific population sub-groups. The development of suitable and attractive products to support individualised, healthy diets and identification of the potential impacts on the food industry are additional important elements.

## **5. Shaping and coping with the 2050 food system**

### *5.1. Understanding the social role of food*

This is done by investigating the role of food beyond nutrition, and the social effects of eating at individual and community level; through identifying the possibilities for and the implications of a change in the perception of the importance of food and nutrition for health, for example, due to a focus on effective cures and treatments for chronic diseases.

### *5.2 Towards a sustainable food system producing safe, affordable and healthy dietary components*

This includes the development of effective integrated approaches to establish, promote and support a sustainable food chain. Example means are effective policy measures, new approaches and technologies to improve efficiency, effective integrated approaches to reduce food waste, as well as the identification of potential risks of (highly complex) food chains and measures to ensure integrity in terms of food safety and food quality.

### *5.3. Supporting technologies to meet societal needs*

This may be accomplished by developing novel or alternative sustainable primary production or manufacturing processes for better nutritional profiles of foods and food components; methodologies for impact assessments of technological developments in the food system and beyond, and effective approaches to communicate and gain acceptance of new food sources and technologies with potential health benefits in sustainable food production.

## **6. Conclusion**

Most of the research priorities identified should be approached in the coming years to deliver results in the short- to mid-term (before 2030), thereby reflecting their urgency. A recurring element in this study is the need for a holistic, interdisciplinary approach that takes into account the complexity of the whole food system. The food system needs to become sustainable, *i.e.* economically viable, socially responsible as well as environmentally benign. The latter calls for a dietary shift, especially when bringing into play the foreseen climate change and natural resource depletion impacts in agriculture and food production. The scenarios developed in this study are intended to contribute to a societal dialogue on how to shape the future food system, while research will provide the evidence necessary for informed decision-making.

## **7. References**

- [1] WHO (2013) Global action plan for the prevention and control of noncommunicable diseases 2013-2020.
- [2] Horizon 2020, the European Framework Programme for Research and Innovation 2014-2020.  
[http://ec.europa.eu/research/horizon2020/index\\_en.cfm](http://ec.europa.eu/research/horizon2020/index_en.cfm)



## **Environmental Impact of the European Food Basket using LCA**

*Bruno Notarnicola<sup>1</sup>, Serenella Sala<sup>2</sup>, Valentina Castellani<sup>2</sup>, Giuseppe Tassielli<sup>1</sup>,  
Pietro A. Renzulli<sup>1</sup>, Malgorzata Goralczyk<sup>2</sup>*

<sup>1</sup>Ionian Department of Law, Economics and Environment, University of Bari Aldo Moro, Bari, Italy

<sup>2</sup> European Commission, Joint Research Centre, Institute for Environment and Sustainability, Sustainability Assessment,  
Via Enrico Fermi 2749; T.P. 290; I-21027 Ispra (VA), Italy  
E-mail contact: brunonotarnicola@uniba.it

### **1. Abstract**

*The work described encompasses an evaluation, in terms of environmental impact, of food consumption in the EU. A quantitative and qualitative analysis of the structure of the EU food consumption was carried out to select a basket of products representative for the structure of 2010 EU-27 food consumption. An LCA of the basket was performed to evaluate the environmental impact of such consumption. The results indicate that in the majority of the environmental impact categories the most burdening foods are meat and dairy. Fruit contributes the least to the overall result because its relatively low impact is coupled with light packaging and lack of home processing or cooking. The agricultural phase is the most burdensome for most impact categories. The end-of-life phase and the losses occurring in all lifecycle phases need to be carefully considered since they can significantly contribute to the overall burden of food consumption.*

### **2. Introduction**

Moving towards more sustainable production and consumption pattern is considered a key element of any policy support aiming at decoupling environmental impacts from economic growth. Life Cycle-based Indicators has been developed by the Sustainability Assessment Unit of the Institute for Environment and Sustainability (European Commission – Joint Research Centre) in order to assess the environmental impact final consumption of goods of an average European citizen. Including mobility, housing and food. The development of such indicators responds to the needs of analysing and monitoring European consumption patterns and their global environmental impact in order to shift to more resource efficient consumption. What follows is a description of the evaluation, in terms of environmental impact, of food consumption, with particular reference to a 2010 EU-27 nutrition basket of products.

### **3. Method**

The work firstly involved a quantitative and qualitative analysis of the structure of the EU-27 food consumption – during the years 2000-2010 – including international trade. This enabled the selection of products representative for the structure of apparent food consumption for the year 2010. Specific data on apparent consumption (Consumption = Production - Exports + Imports) was sourced the Eurostat and FAO databases and from specific nutrition and food consumption literature concerning current emerging consumption trends (e.g. [1], [2], [3], [4]).

The final choice of products for the basket was based on criteria regarding apparent food and drink consumption, prior knowledge concerning foods with a particularly high environmental burden and EU consumption trends of food and drink during the last ten years.

Next an LCA of the products in the basket was carried out, using a common methodology for all the representative products. The functional unit was defined as the average food consumption per person in EU. The inventories constructed for each product regard not only the production phase of single food products but all stages of the food chain including losses and end of life of products and waste. The LCI datasets were constructed based on foreground data obtained from literature, direct industry sources and background data mainly taken from the Agrifootprint and Ecoinvent v.3 databases. The impact assessment method and characterization factors for the assessment of inventories is the ILCD which refers to midpoint impact categories [5].

As depicted by the methodology by Sala et al [6], the assessment of hotspots for basket of products may be followed by the analysis of potential improvement options and subsequent target setting for improvements. Specific targets for the eco-innovation in the food supply chain were identified through a review of documents about eco-innovation in the food sector, such as scientific literature, technical reports (e.g. by DGENV/JRC/etc.), IMPRO studies, Best Available Technologies Reference Document (BREF).

#### **4. Results**

Table 1 illustrates the selected EU-27 basket products and respective data on their apparent consumption. The main results of the LCIA per life cycle phase and for each impact category are illustrated in Figure 1.

The targets identified for the basket of product food may be clustered as referring to three main strategies for reducing the impacts generated by food supply chains:

- i) an environmentally sustainable increase in agricultural productivity coupled with measures aimed at reducing emissions to air, to water and to soil,
- ii) dietary changes on the consumption side (e.g. reducing the consumption of meat and dairy products)
- iii) better efficiency in reducing food losses and managing food waste (e.g. through improved rate of food waste recovery).

Table 1: Basket products and apparent consumption (year 2010, EU-27)

Basket product	Total consumption of basket product (kg/year)	Per-capita apparent consumption (kg/inhabitant.y ear)	% of total per-capita apparent basket consumption	Economic value of the consumption for each basket product (€/year)
Pig meat	20,577,780,453	41.0	7.6%	33,662,075,184
Beef	6,908,857,637	13.7	2.5%	26,364,299,736
Poultry	11,493,631,410	22.9	4.2%	23,205,612,920
Bread	19,753,915,765	39.3	7.3%	26,903,954,621
Milk and Cream	40,246,421,375	80.1	14.8%	22,898,901,633
Cheese	7,519,349,214	15.0	2.8%	28,952,575,241
Butter	1,825,989,144	3.6	0.7%	5,929,095,967
Sugar	14,965,056,818	29.8	5.5%	8,036,450,518
Sunflower oil	2,725,842,346	5.4	1.0%	2,372,460,990
Olive oil	2,680,017,479	5.3	1.0%	4,703,361,683
Potatoes	35,241,000,000	70.1	13.0%	10,166,193,000
Oranges	8,723,122,900	17.4	3.2%	5,096,920,710*
Apples	8,065,996,300	16.1	3.0%	4,730,706,830*
Mineral water	52,741,838,200 (litres)	105.0 (litres)	19.4%	8,920,405,677
Roasted Coffee	1,748,478,908	3.5	0.6%	9,277,724,061
Beer	35,056,541,024 (litres)	69.8 (litres)	12.9%	28,682,876,500
Prepared meat dishes	1,438,891,580	2.9	0.5%	13,737,753,774
<b>TOTAL</b>	<b>271,712,730,553</b>	<b>540.7</b>	<b>100.0%</b>	<b>263,641,369,045</b>

\* Estimated economic value of production

Figure 1: Life cycle impact assessment for an average citizen of EU-27 in the nutrition basket-of-products (in percentage units) based on representative products

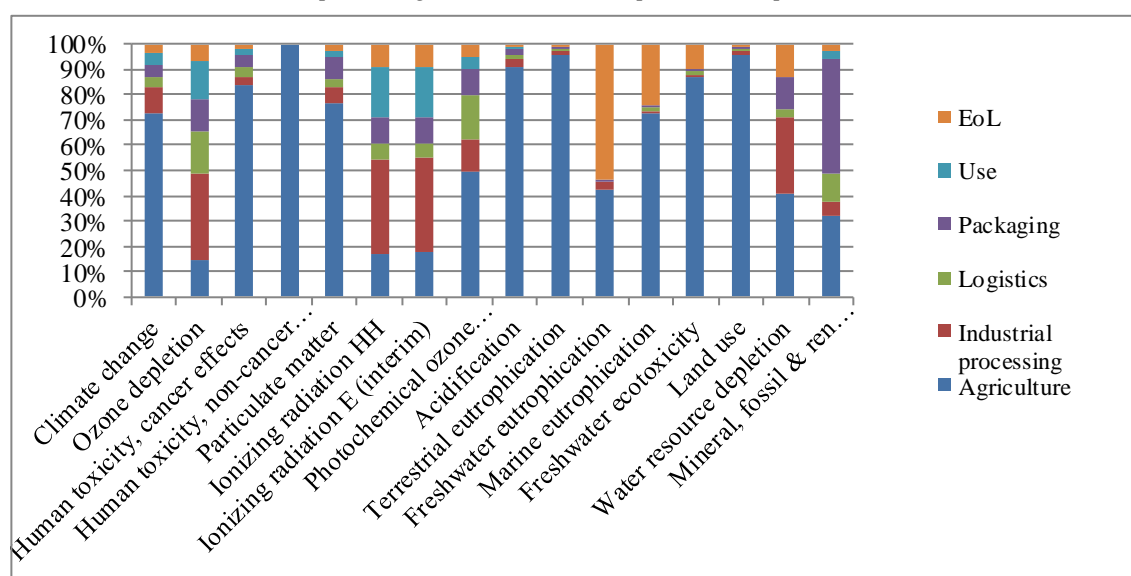

## 5. Discussion and conclusions

The LCA results indicate that in the majority of the environmental impact categories the most burdening foods are meat and dairy. Fruit contributes the least to the overall result because its relatively low impact is coupled with light packaging, consumption of fresh products and the lack of home processing or cooking. The agricultural phase is the most burdensome for most impact categories.

In conclusion, it was found out that the end-of-life phase has to be taken into consideration, especially human excretion and wastewater treatments, because their burden is sometimes higher than others, e.g. that of the transport operations. Furthermore, the losses which occur during the whole life cycle, during agricultural/industrial phases and at home, in terms of food scraps and wastage food, have also be taken into consideration, since they can contribute up to 60% of the initial weight of the food.

The application of the methodology for target setting to the basket of products food has highlighted the need of a complementary approach, where literature review on hotspots is coupled with LCA. In literature, the majority of the studies focus on energy and climate related impacts of food supply chains, whereas the LCA applied to the food BoP supports a more holistic hotspot analysis. Indeed, LCA offers a broader and multi-criteria based assessment of food supply. However, in the future variability and ranges in the underlying datasets may give further relevant input in target setting. For example, consumer choices and behaviour and hence associated datasets may vary considerably, leading to different impacts attributable to the use phase and the overall basket. In general, an uncertainty analysis of the result should be conducted in order to highlight what is the relevance of the hotspots under different assumptions. Any improvement and target should be anyway subject to further evaluation at system level and multi-criteria level to ensure that a benefit in one impact category or life cycle stage is not leading to higher impacts elsewhere.

## 6. Reference

- [1] Consumption and the environment — 2012 update. The European environment state and outlook 2010. European Environment Agency, Copenhagen.
- [2] Family Food (2012). Report published by the Department for Environment, Food and Rural Affairs. Available on the Defra website: <https://www.gov.uk/government/collections/family-food-statistics>.
- [3] FAO (2011). Global food losses and food waste – Extent, causes and prevention. Rome
- [4] European Commission, Agriculture and Rural Development, Product reports. Available from <http://ec.europa.eu/agriculture/fruit-and-vegetables/product-reports/>
- [5] Joint Research Centre - Institute for Environment and Sustainability: International Reference Life Cycle Data System (ILCD) Handbook - General guide for Life Cycle Assessment - Detailed guidance. First edition March 2010. EUR 24708 EN. Luxembourg. Publications Office of the European Union.
- [6] Sala S, Dewulf J, Benini L, 2014. Indicators and targets for the reduction of the environmental impact of EU consumption: Methodology for 2020 targets based on environmental impact indicators. Deliverable 4 of the AA with DG ENV: № 070307/2012/ENV.C.1/635340.

# **Environmental Implications of Dynamic Policies on Food Consumption and Waste Handling in the European Union**

*Michael Martin, Lina Danielsson and Tomas Ekvall*

*IVL-Swedish Environmental Research Institute, Valhallavägen 81, 100 31 Stockholm, Sweden*

*E-mail contact: [michael.martin@ivl.se](mailto:michael.martin@ivl.se)*

## **1. Abstract**

*This study will review the environmental implications of dynamic policy objectives outlined in the EU-FP7 Project DYNAMIX - Decoupling growth from resource use and its environmental impacts to address changes in food consumption, reductions in food waste and a change in waste handling systems. Data from FAOSTAT for the European Union with a base year of 2010 are used and scenarios are created for the years 2030 and 2050 assuming policy instruments are fully effective. Results indicate that reductions in animal-based protein consumption significantly reduce environmental impacts, followed thereafter by reductions in waste which may also lead to reduced food consumption. Despite the positive implications the policy mixes may have for targets for decoupling, they are not enough to meet greenhouse gas (GHG) emissions targets for the EU outlined in the DYNAMIX project.*

## **2. Introduction**

Consumers are becoming more aware of the impact that their behavioral choices may have on the environment. In the developed world, behavioral choices, such as dietary choices, have a large influence on the environmental impact of consumers, and changes to dietary choices may be one of the most economically effective abatement options for climate change. Furthermore, this is coupled with an overall abundance of food production and thus large food wastes. This study will review the environmental implications of possible changes in dietary choices and food waste handling in the European Union based on dynamic policy objectives outlined in the EU-FP7 Project DYNAMIX - Decoupling growth from resource use and its environmental impacts [1]. Policies and their environmental impact implications are tested using life cycle assessment (LCA) methodology to address different scenarios including 1) changes in protein consumption, 2) shifting from consumption from bovine- and pork-based protein sources towards more poultry based protein, 3) providing more vegetable-based protein and 4) reducing landfilling of food wastes through changes in food waste handling.

## **3. Methodology**

Data from Food Balance Sheets by the Food and Agriculture Organization (FAO) are used to identify food consumption for the European Union (EU) with a base year of 2010 [2]. Food consumed in this study included only food for consumption and manufacturing, excluding that used for fodder and seed. Each food category comprises a large number of separate food products, and therefore representative food products (RFPs) were chosen from each category to represent at least 80% of the mass of that product category. A scaling factor was thereafter employed in order to compensate for the food products excluded by choosing

the RFPs. Figure 1 provides a representation of this process for e.g. the Meat category, where only bovine, poultry and pork products represent this category. More information on the modelling can be found in [3].

Figure 1: Method used to identify Representative Food Products and link to Environmental Impacts

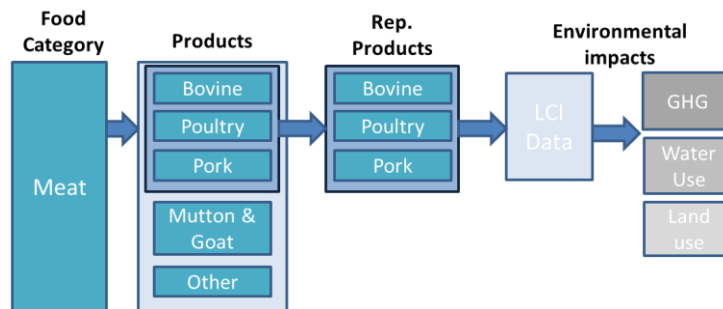

Environmental impact and land use data for the life cycle inventory (LCI) was collected through a meta-study of previous LCAs and data was input for the different RFPs for each food category. Water use figures were provided from [4] for blue water use. When data was not available, comparable data was obtained from databases such as PE International (which recently changed name to Thinkstep) and EcoInvent 2.2. Impact categories in the study are limited to carbon footprint, blue water use and land use due to limited datasets for foods to produce results for further impact categories. For each modelled scenario and year, the environmental impacts are computed by compiling the environmental impacts of the aggregated result of all RFPs. The figures for each food product may differ depending on the scenarios reviewed; see Scenarios section below.

### 3.1 Scenarios

In order to understand the effects of the different policies, scenarios are created for the years 2030 and 2050 assuming policy instruments are fully effective and compared to a reference year of 2010. Scenarios review changes in protein consumption and waste handling and taking into account population increases for future years in the EU, with 518 Million and 526 Million inhabitants in 2030 and 2050, respectively [5]. More information on the scenarios can be found in [3].

### 3.2 Consumption scenarios

Scenario C0 is used to understand the environmental impacts with no policies aimed at decoupling environmental impacts. Scenario C1 takes into account a reduction of the proportion of protein consumption from animal-based sources from 51% in 2010 to 35% in 2030 and 25% in 2050 by reducing meat, dairy and poultry consumption. In scenario C2, policies are used to limit the proportion of animal-based protein sources with large land requirements and resource consumption (including pork and bovine products). A shift to more poultry products and a decrease in bovine products and pork meat is included in this scenario. This includes shifting from protein consumption of 6.2, 11.2 and 8.6 g/capita-day in 2010 to 1.3, 5.2 and 19.5 g/capita-day for bovine products, pork and poultry in 2050, respectively.

### 3.3 Waste scenarios

Scenario W1 will review the implications of reductions in waste (total and avoidable) at the retail and consumer sectors; including reductions of 60% and 85% in 2030 and 2050, respectively.

Scenario W2 will test the same reductions in waste as W1, but will also reduce the food input due to less waste (and less required food inputs). Scenario W3 will review the implications that food donations (20% of otherwise wasted food) from the retail sector may have on the environmental impacts. Scenario W4 will review the implications of changes in waste handling and include the potential benefits from avoided products and energy from an increase in e.g. biogas production and less waste incineration.

## 4. Results

The introduction of policies for the reduction of protein from animal sources may have relatively large environmental impact reductions for European food consumption (Table 1).

*Table 1: Environmental impacts and resource consumption for Consumption (C) and Waste (W) scenarios in the years 2010, 2030 and 2050*

Scenario	GHG Emissions (M Tonnes CO <sub>2</sub> -eq/year)			Land Use (Million ha)			Water Use (Million m <sup>3</sup> )		
	2010	2030	2050	2010	2030	2050	2010	2030	2050
<i>CO</i>	1 357	1 391	1 410	312	320	324	98 698	101 175	102 546
<i>C1</i>	1 357	1 032	792	312	281	216	98 698	97 289	78 896
<i>C2</i>	1 357	1 270	1 228	312	306	300	98 698	101 587	105 537
<i>W1</i>	1 264	1 297	1 315	312	320	324	96 873	99 355	100 733
<i>W2</i>	1 264	1 211	1 195	312	293	291	96 873	89 389	86 956
<i>W3</i>	1 264	1 300	1 318	312	320	324	96 873	99 391	100 735
<i>W4</i>	1 264	1 188	1 218	312	319	323	96 873	96 574	97 081

Overall, the reduction of animal-based protein sources has the largest environmental impact reductions for the scenarios tested. Shifting protein sources from bovine and pork meats to poultry may not have as large environmental impact reductions although reductions may be seen. Environmental impacts may also be reduced in the waste handling scenarios by reducing the amount of landfill and producing more biogas from food waste, due primarily to reduced methane emissions and benefits provided from biogas by-products. However, scenario W2 shows the largest reduction of the waste scenarios, due to accounting for reductions in food consumption. Food donation programs have not shown a significant reduction compared to the other policy objectives, due to the small share of food which can be donated from the retail sector.

The results show a relative decoupling of land and water use in comparison to 2010 levels based on targets outlined in [1]. The large reductions in GHG emissions seen in some scenarios however, may not be enough to significantly contribute to the total per capita emissions target of 2 tonnes CO<sub>2</sub>-eq [1].

Many of the scenarios overshoot the targets from the food production alone, compared to 2010 levels where it accounted for roughly 29% of EU emissions [3].

## 5. Conclusions

Reductions in animal-based protein consumption and reduced food waste landfilling are shown to provide a large decrease in environmental impacts. This offers evidence that, if fully effective, the policy mixes may lead to great reductions in environmental impacts. However, when reviewing a possible decoupling of growth from resource use and environmental impacts to meet European targets, the policy mixes alone may not be enough to reduce impacts from food production and waste handling. This study provides information that can be used by policy makers in addition to the food, feed, retail and waste sectors to reduce environmental impacts associated with food consumption in Europe. Nonetheless, the study only reviews a limited set of impact categories. It is also important to review additional impact categories e.g. nutrient use, land use changes, acidification and eutrophication, which may have significant implications from agricultural practices. However, the importance of consumers to reduce their animal based protein consumption, reduce their creation of food waste and make environmentally conscious dietary choices is stressed in addition to the need for improved sustainable agricultural practices.

## 6. References

- [1] Umpfenbach, K., 2013. Common approach for DYNAMIX. How will we know if absolute decoupling has been achieved? DYNAMIX project.
- [2] FAOSTAT, 2014. Food Balance Sheets. Available at: <http://faostat.fao.org/site/368/default.aspx#ancor> [Accessed Sept 08 2014]
- [3] Ekvall et al. (2015). Physical and environmental assessment. Deliverable 6.1. DYNAMIX project.
- [4] Water Footprint Network, 2015. Water Footprint Network Blue Water Consumption Figures. Available at: [www.waterfootprintnetwork.org](http://www.waterfootprintnetwork.org). [Accessed Jan 02 2015]
- [5] Eurostat, 2015. Population on 1 January 2010. Available at: <http://ec.europa.eu/eurostat/tgm/table.do?tab=table&init=1&language=en&pcode=tps00001&plugin=1>. [Accessed Mar 19 2015]



# How much meat can we eat to sustain a healthy life and planet?

## The case of Swedish meat consumption

Elinor, Hallström<sup>1\*</sup>, Murat Sartas<sup>2,3</sup>, Elin Rööös<sup>2</sup>, Deniz Koca<sup>4</sup>, Pål Börjesson<sup>1</sup>

<sup>1\*</sup>*Environmental and Energy Systems Studies, Lund University, PO Box 118, SE-221 00 Lund, Sweden*

<sup>2</sup>*Swedish University of Agricultural Sciences, Uppsala, Sweden*

<sup>3</sup>*Wageningen University, Wageningen, The Netherlands* <sup>4</sup>*Lund University, Lund, Sweden*

\*E-mail: [Elinor.Hallström@miljo.lth.se](mailto:Elinor.Hallström@miljo.lth.se)

### 1. Abstract

*Sustainability of Swedish meat consumption is assessed from the perspectives of nutrition, health, climate and land use. Our results suggest that more sustainable food systems can be achieved via changes in Swedish meat consumption and that our multidimensional approach can be useful in identifying such changes.*

### 2. Introduction

Production and consumption of food have important impacts on the environment and human nutrition. Meat production, in particular, is identified as a major cause of environmental burden that puts high pressure on global natural resources (1). However, grazing on land non-suitable for cropping, and livestock production systems, such as those based on feed from food waste and/or other by-products, have been put forward as resource-efficient ways of producing food of high nutritional value. In some areas, grazing animals can also contribute to increased biodiversity by keeping landscapes open (2). Meat consumption also affects human health; it contributes with essential nutrients, but it is also associated with certain risk of disease (3). Meat production can be performed in different ways and nutritional needs can be met by different diets varying in quantity and quality of meat. Hence, multidimensional and interdisciplinary assessments of optimal meat production and consumption levels are necessary to achieve healthier and more resilient food systems.

The objective of this paper is two-fold: 1) to estimate what intake levels of meat are compatible with targets for public health and environmental sustainability in Sweden; and 2) to test a methodology that can be further developed into a framework for assessing sustainability of food systems from a multi- and interdisciplinary perspective.

### 3. Methodology

The approach used can be described by the following three steps: 1) key variables influencing the nutritional status, chance/risk of health/disease, greenhouse gas (GHG) emissions and land use demand of meat production and consumption, are identified; 2) a preliminary list of indicators and their (political) targets linked to the variables are identified in the literature and/or developed; 3) levels of sustainable meat consumption in Sweden are calculated, based on a joint assessment of nutritional, health, climate and land use perspectives. For the assessment, data from life cycle assessments and nutritional databases are used (4, 5). To estimate the intake levels from a nutrition and health perspective, consumption of purely red, white and processed meats are assessed, as well as mixed meat which refers to total meat consumption based on a mix of the different meat types.

To assess sustainability from the perspective of GHG emissions and land use, a distinction is made between consumption of beef and chicken from different production systems in Sweden and from other countries and regions which export meat to Sweden.

A public health perspective is applied to assess the nutritional quality and health effects of meat consumption. Thus, the nutrition and health assessment is based on recommendations and guidelines that promote public health, i.e. health for the majority of the people within the studied population, rather than in specific individuals. Also, the focus is on health promotion and disease prevention, in contrast to clinical health assessments focusing on reducing or curing symptoms of disease. Effects of meat consumption are analyzed from a high-income country perspective. The majority of the population is assumed to eat an unrestricted diet, and sustainability indicators and targets are limited to those applicable to high income countries. A near-time perspective is applied, *i.e.* production systems correspond to today's performance without any assumptions on technological development. A more detailed description of the methodology is provided in the complementary materials.

#### 4. Results

Table 1 provides an overview of key indicators, metrics and targets identified to be of importance for assessing sustainability of meat production and consumption in Sweden, from the perspectives of nutrition and health, GHG emissions, climate change, and land use. Identified indicators, metrics and targets are limited to those available for current usage. Table 2 provides an overview of estimated levels of sustainable meat consumption. These levels are compatible with sustainability targets in Table 1, and could thereby be interpreted as sustainable from these perspectives.

Table 1: Impact categories, indicators, metrics, benchmarks and targets identified<sup>1</sup>

IMPACT	INDICATOR / METRIC	BENCHMARK/TARGET
<b>Nutrition &amp; Health</b>		
Nutritional quality, Health	Nutrient content of food consumption ( <i>e.g.</i> nutrient intake capita <sup>-1</sup> day <sup>-1</sup> )	Nutritional recommendations
Nutritional quality, Health	Quantity and quality of meat consumption ( <i>e.g.</i> meat intake capita <sup>-1</sup> day <sup>-1</sup> )	Food-based dietary guidelines
Nutritional quality, Health	Quantity and quality of meat consumption ( <i>e.g.</i> meat intake capita <sup>-1</sup> day <sup>-1</sup> )	Health recommendations and guidelines
<b>GHG emissions &amp; Climate change</b>		
GHG emissions	Quantity and carbon footprint for different meats ( <i>e.g.</i> CO <sub>2</sub> eq. for meat intake capita <sup>-1</sup> year <sup>-1</sup> ).	International climate targets
<b>Land use</b>		
Land use	Quantity of land occupied by meat (livestock) production ( <i>e.g.</i> ha of total land capita <sup>-1</sup> year <sup>-1</sup> )	Global availability of land potentially suitable for agriculture
Land use quality	Quantity and quality of land occupied by meat (livestock) production ( <i>e.g.</i> ha of specific land capita <sup>-1</sup> year <sup>-1</sup> )	Global availability of land potentially suitable for cropping

<sup>1</sup>More details in Table A1 in complementary materials.

Table 2: Estimated levels of sustainable meat consumption from different perspectives<sup>1</sup>

TYPE OF MEAT	MEAT CONSUMPTION (g/d)	
	Raw, bone-free	Cooked, bone free
<b>NUTRITION &amp; HEALTH</b>		
<b>Mixed meat<sup>2</sup></b> Protein	40-90	30-65
<b>Red unprocessed meat</b> Iron Saturated fat Health recommendation	40-255 < 370 < 60	30-180 < 260 < 40
<b>Processed meat</b> Saturated fat Dietary health recommendations	< 130 0 <sup>3</sup>	< 90 0 <sup>3</sup>
<b>White meat</b> Iron	150-275	105-195
<b>GHG EMISSIONS &amp; CLIMATE CHANGE</b>		
<b>Beef</b>	< 70	< 50
<b>Chicken</b>	< 525	< 370
<b>LAND USE</b>		
<b>Beef</b> Global agriculture land Global cropland	< 370 < 110	< 260 < 80
<b>Chicken</b> Global cropland	< 205	< 145

<sup>1</sup> The calculation method is further described in Table A1 and Table A2 in complementary materials. <sup>2</sup>Mixed meat from pork, beef, lamb, game, processed meat products, and chicken. <sup>3</sup>None or as little as possible.

## 5. Discussion

From a nutritional perspective, no general recommendations exist for how much meat is considered optimal for health. Nutritional recommendations are based on intake levels that ensure sufficient intake of critical nutrients (*e.g.* iron) without exceeding upper intake limits of nutrients associated with negative health effects (*e.g.* saturated fat). Meeting iron requirements in fertile women may require intake levels of 105- 195 g of cooked meat per day (under the assumption that white meat is the only meat consumed and that 22% total dietary iron is supplied by meat). However, to supply adequate protein, intake levels of 30-60 g of cooked meat per day are sufficient (under the assumption that maximum 25% of total protein is supplied by protein). Lower intake levels would be possible if a larger proportion of the nutrients were supplied by other food groups. Recommended intake levels of red and processed meat are more restricted compared to white meat, due to the association between red and processed meat and increased risk of colorectal cancer. Adequate nutrition could also be supplied by vegetarian diets, *i.e.* without meat.

From an environmental and land use perspective, no policy guidance or recommendations exist for sustainable levels of meat production. Our results suggest that beef consumption needs to stay below 50 g of cooked meat per day to be deemed sustainable from a climate and land use perspective (under the assumption that beef is the only meat consumed), while for chicken intake levels below 145 g per day can be considered sustainable based on the included indicators (Table 1, A1).

It should be observed that the amounts in Table 1 are maximum intake levels, estimated based on GHG- and land use efficient meat production systems, and therefore may have to be further reduced to be compatible with the selected sustainability targets.

From a nutrition and health perspective, sustainable levels of meat intake are largely dependent on the overall composition of the diet and the amount of nutrients supplied by different food groups. From a climate and land use perspective, sustainable levels of meat intake depend on, *e.g.* how much of total GHG emissions space and agriculture land is attributed to food or meat. Hence, to estimate intake levels of meat compatible with sustainability targets, several indicators, metrics, targets and assumptions need to be used and evaluated. As our methodology and its underlying calculations are hampered by many uncertainties, a thorough assessment and presentation of uncertainties in methods and results is essential. For a more complete assessment, additional perspectives and sustainability indicators, *e.g.* equity, animal welfare, economy, and other environmental and societal concerns, should be included. Hence, the set of parameters identified here can be interpreted as a proxy of sustainable meat consumption in Sweden, valid only for some perspectives. By including more indicators and perspectives, our methodological approach can be developed into a framework to map and model potential interlinkages and relationships between key variables. Such a methodological framework should ideally be applicable to different food groups and diets as well as to different regions and populations.

## 5. Conclusion

Our results suggest that sustainability within the food system can be increased via changes in current Swedish meat consumption patterns, and that our approach can be useful in identifying alternative and more sustainable food consumption patterns.

## 6. References

- [1] Hallström, E., Carlsson-Kanyama, A., Börjesson, P. 'Environmental impact of dietary change: a systematic review'. *J. Clean. Prod.* **91** (2015) 1-11.
- [2] Gerber, P.J., Steinfeld, H., Henderson, B., et al. 'Tackling Climate Change Through Livestock – A Global Assessment of Emissions and Mitigation Options. FAO, Rome, 2013.
- [3] Tilman, D., Clark, M. 'Global diets link environmental sustainability and human health'. *Nature*, **515** (2014) 518-522.
- [4] ISO. 'Life cycle assessment - Principles and framework' in 'Environmental management'. International Organization for Standardization, Geneva, 2006.
- [5] National Food Agency, Sweden. 'Livsmedelsdatabasen' ('The food database') <http://www.livsmedelsverket.se/en/food-and-content/naringsamnen/livsmedelsdatabasen/> (accessed 2015-06-22).

## 7. Complementary Materials

### 7.1 Methodology

Table A1: Assumptions and references used as basis for calculations

	INDICATOR	ASSUMPTIONS
NUTRITION & HEALTH	All essential nutrients	Recommended intake of all essential nutrients are adequately met (1).
	Protein	Protein requirement of 0.8 g of protein per kg body weight and day for adults (2), body weight ranging from 50-90 kg (1). Maximum 25% of total protein supplied by meat (i.e. current Swedish intake) (3). Average protein content of 20% in raw meat <sup>1</sup> (4).  Recommended intake of protein of 10-20 E% (1). Energy requirement for adults ranging of 2300-3300 kcal per day <sup>2</sup> (1), of which maximum 25% is supplied by meat (i.e. current Swedish intake) (3). Protein content of 8-24 g per 100g in raw meat <sup>1</sup> (4).
	Iron	Recommended intake of iron in adult ranging from 9 mg (men and unfertile women) to 15 mg (fertile women) per day (1), of which maximum 22% is supplied from meat (i.e. current Swedish intake) (3). Iron content in raw meat of 1.3-2.6, 0.8-1.9 and 1.2-1.3 mg per 100g of red unprocessed meat <sup>3</sup> , processed meat and white meat <sup>4</sup> , respectively (4).
	Saturated fat	Recommended maximum intake of saturated fat of 10 E% (1), of which maximum 19% is supplied by meat (i.e. current Swedish intake) (3). Energy requirement for adults of 2300-3300 kcal per day <sup>2</sup> (1). Saturated fat content ranging in raw meat from 1.9-4.0, 5.5-9.2 and 3.5-3.8 g per 100g of red unprocessed meat <sup>3</sup> , processed meat and white meat <sup>4</sup> , respectively (4).
	Red meat	Public health recommendation of limiting intake of cooked red meat to maximum 300g per week (5).
	Processed meat	Public health recommendation of avoiding, or limiting processed meat intake as much as possible (5).
CLIMATE	GHG emissions, Climate change	Total GHG emissions limited to 1-2 tonnes of CO <sub>2</sub> eq. per capita per year, of which maximum 0.5 tonnes come from meat production and consumption (6). GHG emissions of 20-41 kg and 2.6 kg CO <sub>2</sub> eq. per kg of bone free meat for beef and chicken, respectively (7).
LAND USE	Global availability of land potentially suited for cropping.	No expansion of current global agriculture land for livestock production to 2050. Maximum (current) use of agriculture land for livestock production of 4000 Mha (8, 9). Global population of 9.5 billion in 2050 (10). Land use demand of 31-250 and 7 m <sup>2</sup> per kg of bone free beef and chicken, respectively (7).
	Global availability of land potentially suited for cropping.	No expansion of current global cropland for livestock production to 2050. Maximum (current) use of cropland for livestock production of 500 Mha (8, 9). Global population of 9.5 billion in 2050 (10). Land use demand of 13-25 and 7 m <sup>2</sup> per kg of bone free beef and chicken, respectively (7).

<sup>1</sup> Meat refers here to pork, beef, lamb, chicken, a variety of meat from game and processed meat products.

<sup>2</sup> 2300 kcal per day refers to adult women with PAL of 1.6, 3300 kcal per day refers to adult men with PAL of 1.8. PAL=Physical Activity Level.

<sup>3</sup> Red unprocessed meat assumed to be unprocessed pork, beef and lamb.

<sup>4</sup> White meat assumed to be chicken

## 7.2 Results

Table A2: Estimated levels of sustainable meat consumption from different perspectives

BENCHMARK/ TARGET	INDICATOR/ METRIC/DATA	TYPE OF MEAT	MEAT CONSUMPTION <sup>1</sup> (g/d)	
			Raw, bone- free weight <sup>2</sup>	Cooked, bone- free weight <sup>2</sup>
<b>NUTRITION &amp; HEALTH</b>				
Nutritional rec.	Nutrient intake	Mixed meat	-	-
Nutritional rec.	Protein intake <sup>3</sup>	Mixed meat	< 90	< 65
		Mixed meat	< 40	< 30
Nutritional rec.	Iron intake	Red unprocessed meat	40-255	30-180
		White meat	150-275	105-195
Nutritional rec.	Saturated fat intake	Red unprocessed meat	< 370	< 260
		Processed meat	< 130	< 90
Food-based dietary and health rec.	Meat intake	Red unprocessed meat	< 60	< 40
		Processed meat	0	0
		White meat	-	-
<b>GHG EMISSIONS &amp; CLIMATE CHANGE</b>				
International climate goals	GHG emissions	Beef	< 70	< 50
		Chicken	< 525	< 370
<b>LAND USE</b>				
Global availability of land potentially suitable for agriculture	Land use	Beef	< 370	< 260
		Chicken	< 205	< 145
Global availability of land potentially suitable for cropping	Land use, Land use quality	Beef	< 110	< 80
		Chicken	< 205	< 145

<sup>1</sup>No waste between production and consumption assumed. <sup>2</sup>30% weight reduction is assumed for cooked meat (11).

<sup>3</sup>Based on two different calculation methods, see table A1.

Table A3: Nutrient content<sup>1</sup> of different types of meat

NUTRIENT CONTENT per 100 g uncooked meat	E nergy (kcal)	Protei n (g)	Fat (g)	Sat fat (g)	Fiber (g/d)	Vit D (µg)	Folate (µg)	Iron (mg)	Zinc (mg)	Selenium (µg)	Sodium (g)
<b>RED UNPROCESSED MEAT (n=x)</b>											
<b>MIN-MAX</b>	106-166	19-26	3.1-10	0.5-4.0	0	0-0.6	1.0-6.0	1.3-4.7	1.0-5.5	2.2-24	0.1-3.0
<b>AVERAGE</b>	173	18	11	4.1	0	0.5	8.7	1,9	2.5	8	0.7
<b>RED (INCL. PROCESSED) MEAT (n=x)</b>											
<b>MIN-MAX</b>	106-253	8.1-26	3.1-23	0.5-9.2	0	0-0.6	1.0-7.0	0.8-4.7	1.0-5.5	2.0-24	0.1-3.0
<b>AVERAGE</b>	162	19	9.1	3.5	0	0.4	7.3	2,1	2.6	8.4	0.7
<b>PROCESSED RED MEAT</b>											
<b>MIN-MAX</b>	188-253	8.1-19	12-23	5.5-9.2	0	0.2-0.3	2.4-7.0	0.8-1.9	1.2-4.9	2.0-5.6	0.2-1.8
<b>AVERAGE</b>	210	16	16	6.7	0	0.2	4.3	1.4	3.3	4.3	0.8
<b>ALL MEAT incl. white meat (n=x)</b>											
<b>MIN-MAX</b>	106-253	8.1-26	3.1-23	0.5-9.2	0	0-1.5	1.0-21	0.8-4.7	1.0-5.5	2.0-24	0.1-3.0
<b>AVERAGE</b>	175	18	11	4.3	0	0.5	7.5	1,9	2.5	7.7	0.8

<sup>1</sup>Data from reference 4.

### 7.3 References

- [1] Nordic Council of Ministers, 'Nordic Nutrition Recommendations 2012', 5<sup>th</sup> Edn (Nord, Copenhagen, 2014).
- [2] World Health Organization, 'Protein and amino acid requirements in human nutrition: report of a joint FAO/WHO/UNO expert consultation'. WHO Technical Report Series 935, (WHO, Geneva, 2002).
- [3] National Food Agency, Sweden. 'Riksmaten - vuxna 2010-11. Livsmedels- och näringsintag bland vuxna i Sverige' (Food and nutrient intake among adults in Sweden 2010-2011). (National Food Agency, Sweden, Uppsala, 2012).
- [4] National Food Agency, Sweden. 'Livsmedelsdatabasen' ('The food database') <http://www.livsmedelsverket.se/en/food-and-content/naringsamnen/livsmedelsdatabasen/> (assessed 2015-06-22).
- [5] WCRF/AICR, 'Food, Nutrition, Physical Activity, and the Prevention of Cancer: a Global Perspective', (AICR, Washington DC, 2007).
- [6] Rööf, E., 2013. 'Analysing the Carbon Footprint of Food. Insights for Consumer Communication', (Swedish University of Agricultural Sciences, Uppsala, 2013).
- [7] Hallström E, Rööf, E., Börjesson, P. 'Sustainable meat consumption: a quantitative analysis of nutritional intake, climate impact and land use from a Swedish perspective'. *J. Food Policy* **47** (2014) 81-90.
- [8] FAOSTAT, 'Land use' <http://faostat3.fao.org/home/E> (assessed 2015-06-22)
- [9] Stenfield, H., et al., 'Livestock's long shadow: environmental issues and options'. *Ren Resc* **24** (2006) 15-17.
- [10] United Nations, 'World Population Prospects: The 2012 Revision', (UN, New York, 2013).
- [11] Hallström, E. and Börjesson, P., 'Meat Consumption Statistics - Reliability and Discrepancy'. *J. Sust. Sci. Prac. & Policy* **8** (2013) 37-47.

# **Carbon footprint of Italian eating habits: how consumer food choices might lead to a reduction of greenhouse gas emissions**

Laura Tagliabue<sup>1</sup>, Jacopo Famiglietti<sup>1\*</sup>, Stefano Caserini<sup>2</sup>, Mario Motta<sup>1</sup>, Matteo Zanchi<sup>1</sup>

<sup>1</sup> Politecnico di Milano, Dipartimento di Energia, Via Lambruschini 4, 20156 Milano

<sup>2</sup> Politecnico di Milano, Dipartimento di Ingegneria Civile e Ambientale, P.zza Leonardo Da Vinci 32, 20133 Milano

\*E-mail contact: [jacopo.famiglietti@polimi.it](mailto:jacopo.famiglietti@polimi.it)

## **1. Abstract**

*The production and consumption of food is responsible for a large portion of anthropogenic greenhouse gas (GHG) emissions. The carbon footprint of the Italian food system was estimated with a “cradle to grave” approach, including post-production food waste. In order to evaluate the mitigation potential of consumers’ behavioural changes, a database was compiled with approximately 1,250 values of carbon footprint of food and beverage products, obtained by a systematic review of scientific literature. Then, four diet scenarios, comparable in terms of both energy and protein content, were considered: the current Italian diet, the same diet with a shift from beef to poultry meat, the typical Mediterranean diet, and a vegetarian diet. Results show that per-capita food-related GHG emissions could be reduced by up to 36%, combining dietary changes and food waste reduction.*

## **2. Introduction**

To stabilize greenhouse gas (GHG) concentration in the atmosphere and thereby limit the global warming, the reduction of GHG emissions in the coming decades will have to be very consistent and should cover all sectors; not only the energy system that holds the main responsibility for direct global emissions [1]. Based on actual and expected increases in food consumption, the available projections indicate that, without actions, the GHG emissions from the agricultural sector will rise [2]. This aspect has been considered for the first time in the Intergovernmental Panel on Climate Change (IPCC) Fifth Assessment Report – Working Group III [1]; direct GHG emissions from agricultural activities related to food production are reported to be 10-12% of total GHG emissions worldwide, 2-4% less than the total direct emissions from transport. It is therefore of great interest to compare the contribution to GHG emissions of different food products, in order to assess the benefits that could result from a global transition to food products associated with low emissions.

## **3. Carbon footprint of Italian eating habits**

In order to carry out the analysis, a database of approximately 1,250 carbon footprint of products (CFPs) was set up. The database is organised in 320 food and drink items, and aggregated into 48 product categories. The CFP values (from cradle to retail, excluding related food waste) were gathered from scientific literature data. For the construction of the database the following sources were used: a database published by the Barilla Center for Food & Nutrition (BCFN) [3], two recent scientific articles (Saxe et al 2012 and Hoolohan et al 2013) [4] [5], a publication of the Product Sustainability Forum (PSF) [6], and various Environmental Product Declarations (EPDs) published in the International EPD<sup>®</sup> System [7].



Figure 1 shows the resulting CFPs of the most significant food and beverage categories, together with the main statistics for each product group: minimum and maximum values, median, mean, and interquartile range (25% and 75%).

Figure 1: Representative carbon footprint of product (CFP) values for 26 different food groups (in brackets the number of CFP data collected for each category). For beef meat the maximum value is out of range and is equal to 83.5 [kgCO<sub>2</sub>e/kg]

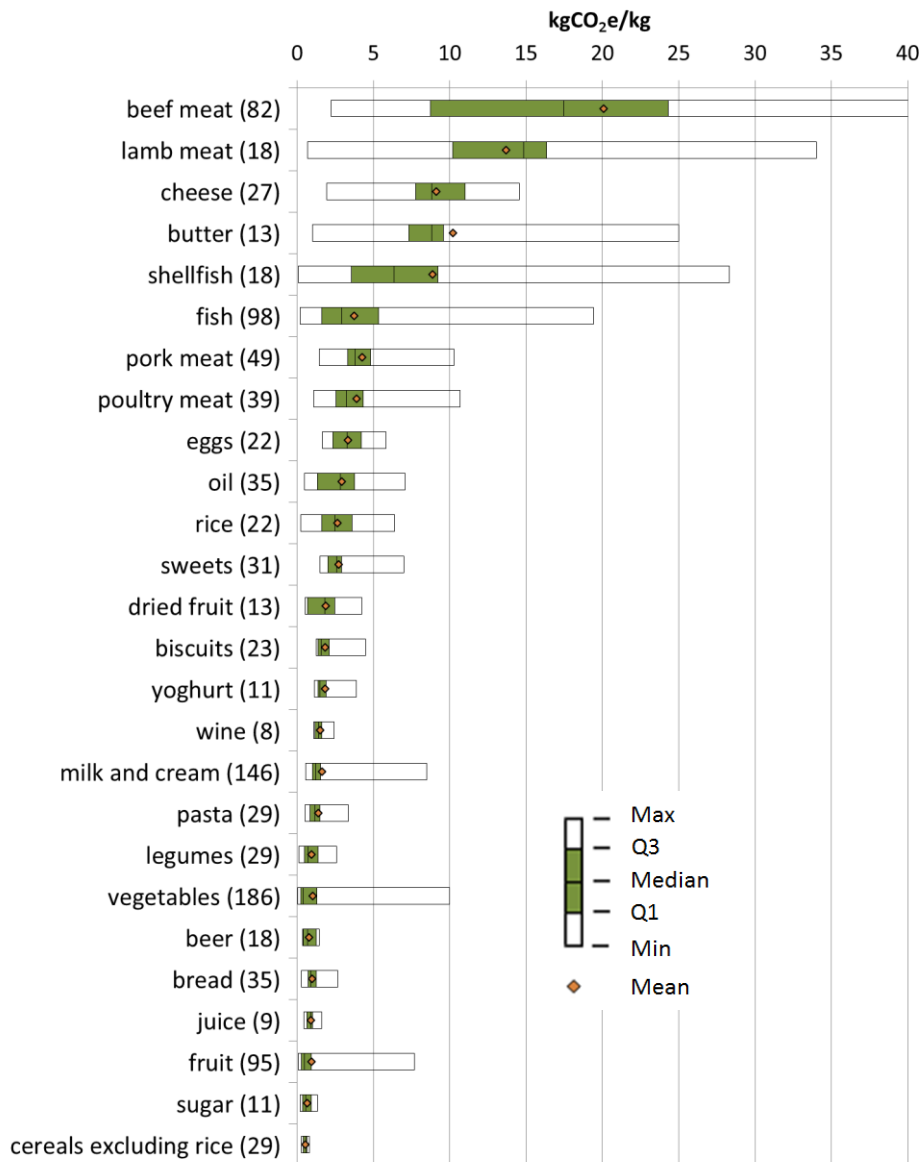

### 3.1 Carbon footprint of different types of diets

Globally, one third of edible food produced for human consumption is lost every year [8]. Therefore, it is important to consider in the CFP assessment the food made available to consumers, not only the amount they actually eat. The annual food balance prepared by the Food and Agriculture Organization (FAO) Statistics Division (FAOSTAT) for each country provides an essential starting point for the study. The most recent food balance sheet for Italy (2011) [9] contains information on food available to consumers in terms of quantity (considering domestic production, imports, and exports) as well as energy (kcal), protein, and fats.

In the FAOSTAT balance sheets, food and drinks are broken down into 69 product groups, and the total availability of food amounted to 1,020 kg inhabitant<sup>-1</sup> year<sup>-1</sup> (edible and non-edible fraction). For each of these 69 product groups, a corresponding item was identified in the database (Figure 1) and the average “cradle to retail” CFP value calculated. Some food items require to be cooked before consumption (*e.g.* rice, meat); to take into account heat used in the preparation stage of these products, specific emissions for cooking were added using the representative data reported in [3]. By multiplying each of the 69 product groups in the FAOSTAT balance sheet by these specific life cycle emission factors, the impact of the Italian diet was estimated taking into account both food actually consumed and food wasted at point of sale and by the final consumer. The result is 7.6 kgCO<sub>2</sub>e inhabitant<sup>-1</sup> day<sup>-1</sup>. Considering the entire Italian population (59.5 million people) [10], food-related emissions amount to 165 MtCO<sub>2</sub>e year<sup>-1</sup>, 55% more than the total direct emissions from the transport sector in Italy [11].

The amount of edible products that are wasted in Italy (105 kg inhabitant<sup>-1</sup> year<sup>-1</sup>) and the relative GHG emissions (238 kgCO<sub>2</sub>e inhabitant<sup>-1</sup> year<sup>-1</sup>) were calculated assuming plausible values for the edible portion of each type of food and applying the average FAO percentages of European edible food that is wasted at the distribution and consumption stages [8]. Thus the maximum mitigation potential of cutting out all avoidable post production food waste in the current Italian food system is 12% of current GHG emissions from food production and consumption.

In order to estimate potential reductions of GHG emissions by dietary changes, four diet scenarios, comparable in terms of both energy (about 2,500 kcal inhabitant<sup>-1</sup> year<sup>-1</sup>) and protein content, were considered: the current Italian diet, the same diet with a shift from beef to poultry meat, the typical Mediterranean diet (as indicated by the Istituto Nazionale di Ricerca per gli Alimenti e la Nutrizione (INRAN)) [12], and a vegetarian diet (as indicated by the Associazione Italiana per la Ricerca sul Cancro (AIRC)) [13]. The largest reduction in GHG emissions is achieved with the vegetarian diet (24% reduction), while following the Mediterranean diet and changing beef with poultry meat in the current Italian diet could lead to a 19% and 13% reduction, respectively. Obviously, more pronounced emission reductions could be achieved combining dietary changes and tackling waste generation in the post-production food supply chain (up to 36% in case of the vegetarian diet).

#### **4. Conclusion**

The results presented here indicate that substantial reductions of carbon footprint of eating behaviour can be obtained by reducing food waste, *via* a lower consumption of meat and a higher intake of vegetable protein, or by just preferring chicken or pork over beef. These measures can also have important added benefits for human health, *e.g.* reducing the risk of developing cardiovascular disease and certain types of cancer [2].

Moreover, dietary changes can play an important role in future climate change mitigation policies. The transition to a diet with a lower meat consumption could have a huge effect on global agricultural land use, as it would free up a grazing area of 2.7 billion hectares and 0.1 billion hectares of farmland, with a consequent absorption of carbon for revegetation of the same extensions [14], and also could have positive

effects on biodiversity [2]; furthermore, it would significantly reduce emissions of CH<sub>4</sub> and N<sub>2</sub>O and would decrease the mitigation costs of achieving a 450 ppm CO<sub>2</sub>e target by 2050.

In relation to the dietary transition there are also socio-economic implications and agro-economic consequences not discussed in this document, whose might offset some of the gains analysed here [14].

Finally, it should be remembered that per capita meat consumption is very unequal, for example in sub-Saharan Africa it is one eighth relative to industrialized countries. In poorest countries where nutrition is insufficient and unbalanced meat represents the most concentrated source of vitamins and minerals [15].

Therefore, the lowering of meat consumption levels could start in countries where they are already excessive (*e.g.* from a nutritional point of view) [15], *i.e.* countries that are expected to lead the way in reducing GHG emissions.

## 5. References

- [1] Edenhofer O., Pichs-Madruga R., Sokona Y. et al. (eds.), 'Climate Change 2014, Mitigation of Climate Change. Contribution of Working Group III to the Fifth Assessment Report of the Intergovernmental Panel on Climate Change', Cambridge, United Kingdom and New York, NY, USA, (2014).
- [2] Tilman D. and M. Clark M., 'Global diets link environmental sustainability and human health', *Nature*, vol. 515, no. 7528, (2014) pp. 518–522.
- [3] Barilla Centre for Food & Nutrition, 'Doppia Piramide 2014 : Stili alimentari e impatto ambientale' (2014).
- [4] Saxe H., Larsen T. M., and Mogensen L., 'The global warming potential of two healthy Nordic diets compared with the average Danish diet', *Clim. Change*, vol. 116, no. 2, pp. 249–262, 2012.
- [5] Hoolohan C., Berners-Lee M., McKinstry-West J., and Hewitt C. N., 'Mitigating the greenhouse gas emissions embodied in food through realistic consumer choices', *Energy Policy*, vol. 63, (2013) pp. 1065–1074.
- [6] Fisher K., James K., Sheane R., Nippres J., Allen S., Cherruault J.-Y., and Fishwick M., 'An initial assessment of the environmental impact of grocery products', *Product Sustainability Forum* (2013).
- [7] The International EPD® System, 'Environmental Product Declaration.' [Online]. Available: <http://www.environdec.com/en/EPD-Search/>.
- [8] Gustavsson J., Cederberg C., Sonesson U., van Otterdijk R., and Meybeck A., 'Global food losses and food waste. Extent, causes and prevention', (Rome 2011).
- [9] FAOSTAT, 'Food Balance sheet for Italy 2011', 2014. [Online]. Available: <http://faostat.fao.org/site/368/DesktopDefault.aspx?PageID=368#ancor>.
- [10] ISTAT, '15° Censimento della popolazione e delle abitazioni 2011' (2013).
- [11] ISPRA, 'Italian Greenhouse Gas Inventory 1990-2012, National Inventory Report 2014' (2014).
- [12] Aureli D. P., Branca D. F., and Amicis D. A. D., 'Linee guida per una sana alimentazione italiana', (2003).
- [13] AIRC, 'Come comporre un menu vegetariano', 2014. [Online]. Available: <http://www.airc.it/prevenzione-tumore/alimentazione/dieta-vegetariana/menu-vegetariano/>.
- [14] Stehfest E., Bouwman L., van Vuuren D. P., den Elzen M. G. J., Eickhout B., and Kabat P., 'Climate benefits of changing diet', *Clim. Change*, vol. 95, no. 1–2, (2009) pp. 83–102.
- [15] Godfray H. C. J., Beddington J. R., Crute I. R., Haddad L., Lawrence D., Muir J. F., Pretty J., Robinson S, Thomas S. M., and Toulmin C., 'Food Security : The Challenge of Feeding 9 Billion People', *Science* (80-. ), vol. 327, no. February, (2010) pp. 812–818.

# **Product Environmental Footprint in the food sector**



# Developing Product Environmental Footprint Category Rules for Olive Oil

Hanna L. Tuomisto<sup>1</sup>, George Michalopoulos<sup>2</sup>, Claudio Pattara<sup>3</sup>, Juan Antonio Polo Palomino<sup>4</sup>, Carlo Russo<sup>5</sup>,  
Giulio Mario Cappelletti<sup>5</sup>, Giuseppe Martino Nicoletti<sup>5</sup>, and Erwan Saouter<sup>1</sup>

<sup>1</sup> European Commission, Joint Research Centre, Institute for Environmental and Sustainability, Ispra (VA), Italy

<sup>2</sup> RodaxAgro Ltd, Kottou 48, Metamorphosis, Attikis, Athens, Greece

<sup>3</sup> Department of Economics, University "G. d'Annunzio", Pescara, Italy

<sup>4</sup> CO2 Consulting, Córdoba, Spain

<sup>5</sup> University of Foggia, Foggia, Italy

E-mail contact: hanna.tuomisto@jrc.ec.europa.eu

## 1. Abstract

*In the context of the Communication "Building the Single Market for Green Products", the European Commission (EC) recommends a method to measure the environmental performance of products, named the Product Environmental Footprint (PEF). The PEF is a multi-criteria measure of the environmental performance of goods and services from a life cycle perspective. Currently, 25 pilot projects test the development of Product Environmental Footprint Category Rules (PEFCRs) for various products. This paper gives an overview of the process of developing the PEFCR for olive oil. An overview of the methods and initial results of the PEF screening study that aims at identifying the most relevant environmental impacts, processes and elementary flows are presented. The screening study assesses the impacts of the average olive oil consumed in the European markets.*

## 2. Introduction

In the context of the Communication "Building the Single Market for Green Products" [1], the European Commission (EC) recommends a method to measure the environmental performance of products, named the Product Environmental Footprint [2]. The PEF is a multi-criteria measure of the environmental performance of goods and services from a life cycle perspective. PEF studies are produced for the overarching purpose of seeking to reduce the environmental impacts associated with goods and services, taking into account supply chain activities (from extraction of raw materials, through production and use, to final waste management). As the PEF guidelines are overall guidelines that have to be applicable to all products, additional product specific guidelines are needed. To address this issue, the EC launched in 2013 a three-year pilot project to develop Product Environmental Footprint Category Rules (PEFCRs) that provide category-specific guidance for calculating and reporting life cycle environmental impacts of products in a harmonised way. The ongoing 25 PEF pilots, consisting of various stakeholders, have the tasks to develop PEFCRs in a process that includes public consultations, reviews and approvals by the Environmental Footprint pilot Steering Committee that includes representatives from each pilot, EU Member States and NGOs. The pilots for 11 food, feed and drink related product categories started in June 2014, including pilots for beer, coffee, dairy, feed, seafood, meat, pasta, packed water, olive oil and wine. This paper focuses on the PEFCR development for olive oil.

### **3. Methods**

In the PEF olive oil pilot, the unit of analysis is defined as one litre of packed olive oil that is consumed as food (e.g. for cooking or as salad dressing). The system boundaries cover the processes from cradle to grave. It is considered that during the use phase environmental impacts will occur only from transportation and end of life of the packaging, while the impacts related to cooking and washing dishes are not included. The EF impact categories and assessment methods are presented in the PEF guide [2] and the normalisation factors in Benini et al. [3]. For weighting, equal weighting for all impact categories is used.

A screening study to identify the most contributing life cycle stages, processes, environmental impact categories and elementary flows is carried out for a representative product that describes the average olive oil sold in the European markets. Intermediate representative products are developed for the following olive oil types: virgin olive oil (including lampant, virgin and extra virgin olive oils), refined olive oil and refined pomace oil. The packaging for the virtual olive oil is constructed from the average European mix of three types of packaging: glass, polyethylene terephthalate (PET) and metal cans (composed by aluminium, tin and steel).

As over 70% of the olive oil in the world is produced in Spain, Italy and Greece [4], the production systems in those three countries are used as basis for the modelling. The data for the screening study was mainly taken from past olive oil LCA studies and Environmental Product Declarations (e.g. [5-7]) and some data was collected directly from the industry. For the Greek olive oil production, data from the LIFE+ project oLIVE CLIMA [8] was used.

An economic allocation is used to divide the upstream burden of olive production between the co-products of industrial stages (i.e. different olive oil types and dry pomace used for energy generation).

### **4. Results**

Some preliminary results of the contribution analysis for virgin olive oil packed in a litre glass bottle are presented in Figure 1. The results are presented here only for impact categories that have robustness rating I or II [9]. Therefore, the results for the following EF impact categories were not included in this paper (but will be included in the screening report): ecotoxicity, human toxicity, water depletion and land use. The global warming impact category shown in Figure 1 does not include biogenic greenhouse gas emissions. According to the PEF guidelines, biogenic carbon flows must be reported separately. The results show that the most contributing life cycle stage in all impact categories is olive production with contribution around 45-95 % of the total impact depending on the impact category (Figure 1). The second and third most contributing life cycle stages are virgin olive oil extraction and packaging.

Figure 1: Contribution of the different life cycle stages on the environmental footprint of virgin olive oil production for selected Environmental Footprint impact categories

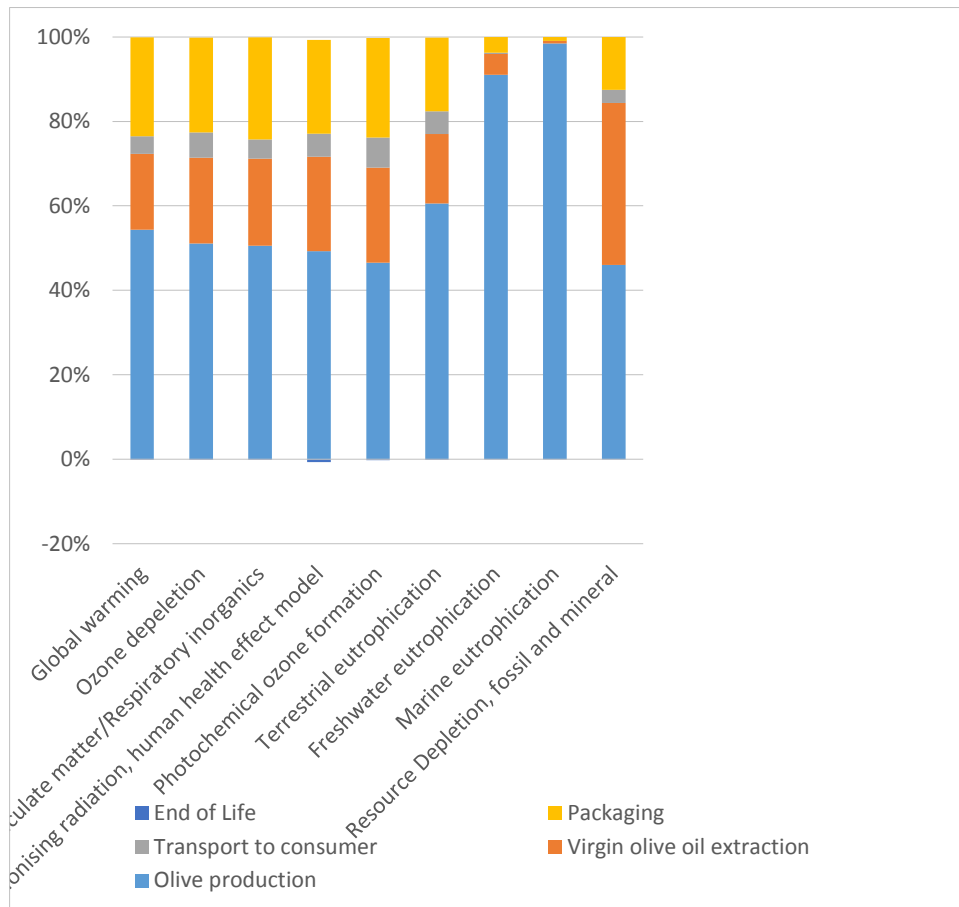

In the olive production phase, the most contributing processes are the production and use of fertilisers and plant protection products. In addition, soil management, pruning and harvesting practices have a relative high contribution in particulate matter/respiratory inorganics, photochemical ozone formation and resource depletion (fossil and mineral) impact categories.

#### 4.1 PEFCR development

The results of the full screening study will be used as a basis for the draft PEFCR for olive oil. Once the draft PEFCR has gone through a public stakeholder consultation [10] and has been approved by the EF steering committee, it will be tested in supporting studies, which will apply the PEFCR for real products. During the supporting studies, also various ways of communicating the environmental footprint results to consumers and businesses will be tested. The PEFCR will be revised based on the lessons learned from the supporting studies, after which the stakeholders have another opportunity to provide comments on the PEFCR. Before final approval of the PEFCR by the EF steering committee, the PEFCR will be reviewed by external reviewers. The final PEFCRs are scheduled to be released by end of 2016.



## 5. References

- [1] Communication from the Commission to the European Parliament and the Council (2013) 196. Building the Single Market for Green Products.
- [2] European Commission (2013). "Annex II to Recommendation (2013/179/EU) on the use of common methods to measure and communicate the life cycle environmental performance of products and organisations.
- [3] Benini, L., Mancini, L., Sala, S., Manfredi, S., Schau, E.M. and Pant.R. (2014) Normalisation method and data for Environmental Footprints; Report EUR 26842 EN. European Commission Joint Research Centre.
- [4] International Olive Council. <http://www.internationaloliveoil.org/>. Cited on 1 September 2014.
- [5] Salomone, R. Cappelletti, G.M, Ioppolo, G. Italian experiences in Life Cycle Assessment of olive oil: a survey and critical review, Proceeding of the "LCA Food 2010, 7th International Conference on Life Cycle Assessment in the Agri-Food Sector". (2) 265-270. Bari, Italy, September 22–24, 2010. ISBN 978-88-88793-29-0
- [6] Cappelletti, G.M. Ioppolo, G. Nicoletti, G.M. Russo, C. 'Energy requirement of extra virgin olive oil production', Sustainability, 6 (8), 2014, 4966-4974, ISSN 2071-1050, DOI 10.3390/su6084966
- [7] Salomone, R. Cappelletti, G.M, Malandrino, O., Mistretta, M., Neri, E. Nicoletti, G.M., Notarnicola, B., Pattara, C. Russo, C., and Saija, G. Life Cycle Assessment in the Olive Oil Sector. pp. 57-122. In B. Notarnicola et al. (eds.), Life Cycle Assessment in the Agri-food Sector, Springer, London, February 2015, DOI 10.1007/978-3-319-11940-3-2, ISBN 978-3-319-11939-7
- [8] the LIFE+ project oLIVE CLIMA. [www.oliveclima.eu](http://www.oliveclima.eu)
- [9] ILCD handbook. International Reference Life Cycle Data System. European Commission, Joint Research Centre, 2010.
- [10] Stakeholders can register to follow pilots on Environmental Footprint wiki-page:  
<https://webgate.ec.europa.eu/fpfis/wikis/display/EUENVFP/EU+Environmental+Footprint+Pilot+Phase>



# **Pesticide emissions in the Environmental Product Footprint – Lessons learnt from refined sugar from sugar beet**

Authors: Gioia, Garavini<sup>1</sup>; Alessandra, Zamagni<sup>1</sup>; Pier Luigi Porta<sup>2</sup>; Paolo, Masoni<sup>2</sup>; Gabriele Facibeni<sup>3</sup>; Valentina Fantin<sup>2</sup>; Serena Righi<sup>3</sup>

<sup>1</sup>Ecoinnovazione srl, ENEA spin-off. Via Guido Rossa 26, 35020 Ponte San Nicolò (Padova)

<sup>2</sup>ENEA, Via Martiri di Monte Sole 4, 40129 Bologna

<sup>3</sup>University of Bologna, CIRSA (Centro Interdipartimentale di Ricerca per le Scienze Ambientali), Via dell'Agricoltura 5, 48123 Ravenna

E-mail contact: [a.zamagni@ecoinnovazione.it](mailto:a.zamagni@ecoinnovazione.it)

## **1. Abstract**

*The choice of models to estimate emissions from pesticide use represents a key methodological aspect but to date a common agreement in the scientific community has not been achieved yet. This paper discusses the application of the PestLCI2.0 model to the case study of refined sugar from sugar beets, evaluating its feasibility and robustness, and considering the main criticalities at the level of both inventory and impact assessment. The study points out that, despite the non-homogeneous coverage of the pesticide emissions and of their effects, their inclusion in the study is of paramount importance. We suggest favouring completeness over precision in the study, as key aspect for operationalizing the materiality principle fostered by PEF.*

## **2. Introduction**

The harmonisation of methods and models to account for the potential environmental impact of products and organisation is at the core of many European and international initiatives. The European Commission's initiative "A single market for green products" [1] promotes the Product and Organisation Environmental Footprint (PEF and OEF, respectively) methods, whose development is presently undergoing in several pilots. The harmonisation process is built upon previous initiatives such as the ENVIFOOD Protocol [2] and the Environmental Product Declaration (EPD) systems. A common aspect of all the initiatives is the product category rule (PCR) concept, i.e. the definition of technical criteria and data for a specific product-group, which can increase consistency in LCA applications and support comparability.

A key methodological aspect, not implemented yet in any of the above-mentioned initiatives, is the choice of models to estimate emissions from pesticide use. In fact, different approaches have been developed, but a common agreement in the scientific community has not been achieved yet.

We have addressed the issue of pesticide emissions in the evaluation of the environmental footprint of refined sugar from sugar beet. Given that product environmental footprint category rules for sugar are not under development in the pilots and the PCR of the International EPD system does not account for emissions from pesticide use, we have adopted the PestLCI2.0 model to assess the pesticide emissions to the ecosphere. This paper discusses the application of the PestLCI2.0 model in terms of feasibility and robustness, considering the main criticalities at the level of both inventory and impact assessment.

### 3. Methods

The PestLCI 2.0 model [3] estimates the fraction of pesticide applied in the technosphere, which migrates to the environment (air, surface water and groundwater) by crossing the technosphere-environment borders. In PestLCI the technosphere boundaries are defined to be horizontally the arable field borders, and vertically from 1 m soil depth up to 100 m up into the air column. The model does not take into account the emissions to soil outside the technosphere because they are assumed to occur only indirectly after the emission of pesticide in the other compartments. Considering that the distribution of pesticide emissions between environmental compartments strongly depends on local climate and soil characteristics [3], the model has been adapted to allow the user to select different European climate scenarios and soil profiles as well as to adjust additional parameters such as field characteristics and pedo-climate values.

We have applied PestLCI 2.0 - which includes one climate scenario for the agricultural zone investigated in our study (considering the monthly fluctuation of temperature, precipitation, solar irradiation and the potential water balance) - in the framework of a PEF study of refined sugar from sugar beets, which is cultivated and processed in Italy. The unit of analysis is 1 kg of refined sugar from sugar beet packed into 1 kg carton box for sale by retailers (NACE code: C10.8.1). The system boundaries are from cradle to grave and the reference year is 2013. The study has been developed with the support of GaBi 6 software and Ecoinvent 2.2 database. All the impact categories required by the PEF methodology were considered, but this article will analyse only those related to toxicity.

The following input data have been collected and estimated: i) the pesticide active ingredient; ii) the crop on which they are applied, iii) the soil profile and the climate zone, iv) the period on which the pesticide is applied (month), v) the application rate; vi) the tillage type and the field dimensions (width, length and slope).

The other parameters (called “adjustable model parameters”) set by the model (ex. solid material density, fraction macropores) are assumed to be unchanged, even though, according to expert judgment, their default values cannot be considered representative of the agricultural land area under study [4]. As far as the completeness is concerned, the PestLCI 2.0 database does not have all the active ingredients of the pesticides used in the sugar beet cultivation (70% completeness as number of available pesticides). Therefore, proxies with the same pesticide’s function have been selected in those cases.

Regarding the impact assessment phase, the USEtox recommended method has been applied. Currently USEtox cannot handle groundwater emissions [5], therefore those emissions have been neglected in the impact assessment with an average mass loss from 2 to 6% of the relative pesticide emissions. Moreover, there is not a full coverage of the characterization factors (CFs) at environmental impact categories levels. In this case study, all the analysed pesticides’ CFs for Ecotoxicity freshwater are included, a few CFs are available for the Human toxicity non cancer effects (45% as number of CFs available), while none for Human toxicity cancer effects.

## 4. Results

The study points out that the cultivation of the sugar beet represents the most relevant phase in refined sugar's life cycle for the majority of the analysed impact categories. Regarding the impact categories related to toxicity, the contribution of pesticides both to the whole life cycle and to the cultivation phase are illustrated in figure 1.

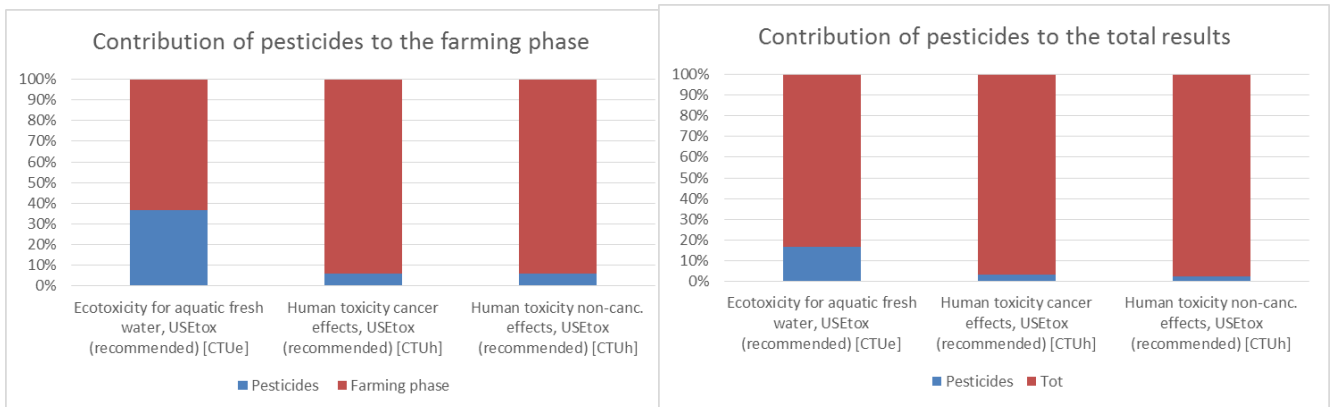

Figure 1: Contribution of the pesticides to the total results (on the right) and to the farming phase (on the left) of the impact categories related to toxicity

The contribution of pesticides to the total result of cultivation phase is equal to 37% for the Ecotoxicity for aquatic fresh water and 6% for the Human toxicity cancer and non-cancer effects. Other important contributions to these categories are related to the production and the use of NPK fertilisers (28% for the Ecotoxicity for aquatic fresh water, 42% for Human toxicity non cancer effects and 52% for the Human toxicity cancer effects) and the agricultural work processes (43% for the Ecotoxicity for aquatic fresh water, 68% for Human toxicity non cancer effects and 59% for the Human toxicity cancer effects), in particular ploughing and irrigation.

Among the pesticides, herbicides are those that affect most the Ecotoxicity freshwater results. Nevertheless, it should be noted that these results are underestimated, due to the non complete coverage of CFs discussed in section 2. Furthermore, in the LCA software there is not a full coverage of the CFs for all the environmental compartments due to the different level of robustness of the USEtox characterization flows (interim and recommended), therefore only the recommended factors have been implemented in the software.

## 5. Conclusion

The case study pointed out that a proper evaluation of the toxicity impact category within a PEF study is challenging due to the calculation of pesticide emissions at LCI level and to the LCIA modelling. Regarding the inventory, information about field characteristics in the sugar beets cultivation has been collected as well as that related to the pesticide application period, in order to have an estimation of the influence of spatial and temporal aspects on pesticide dynamics. However, the following limitations can be identified in the study and in PestLCI 2.0: i) the default values of the adjustable parameters - in particular for soil that are non-representative of the Italian agricultural area; ii) the limited number of pesticides included in the

PestLCI model; iii) no possibility to manage the background parameters (such as buffer zone width in pesticide database) that can lead to inconsistencies in the model's outputs. In particular, buffer zones are not considered in our study, but a deeper analysis on the Italian regulation related to the sugar beet cultivation areas should be done because their presence can affect the off-field emissions, in particular the emissions to air due to wind drift; iv) the assumption to consider only the distribution of the pesticide's active ingredient, omitting the contribution of by-products used in pesticide formulations, such as adjuvants and solvents [6].

As far as the LCIA modelling is concerned, there is not a full match between PestLCI 2.0 model and USEtox: the former does not take into account the emissions to soil, while the latter has not developed yet CFs for groundwater emissions. Moreover, in USEtox there is a low availability of the pesticides' CF for the impact categories of Human toxicity and the consideration of different levels of robustness for the same compound leads to an uncomplete implementation in LCA softwares.

However, despite the non-homogeneous coverage of the pesticide emissions and of their effects, their inclusion in the study is of paramount importance and they need to be traced at least at inventory level. In fact, according to the materiality approach fostered by PEF, their contribution to the overall performance of the product is relevant and the company has a certain level of influence on them. Thus, the incomplete inventory and LCIA should not prevent the opportunity to intervene on the process: while working on making the models more accurate, we suggest favouring completeness over precision in the study, following the materiality principle.

## **6. Acknowledgment**

We gratefully acknowledge the funding of Eridania Sadam and their support in providing the data for the study.

## **7. References**

- [1] COM/2013/0196 final. Building the Single Market for Green Products Facilitating better information on the environmental performance of products and organisations.
- [2] Food SCP RT (2013), ENVIFOOD Protocol, Environmental Assessment of Food and Drink Protocol, European Food Sustainable Consumption and Production Round Table (SCP RT), Working Group 1, Brussels, Belgium.
- [3] Dijkman T. J., Birkved M., Hauschild M. Z., "PestLCI 2.0: a second generation model for estimating emissions of pesticides from arable land in LCA". *Int J Life Cycle Assess* 17 (2012), 973–986
- [4] Ecoinnovazione, 2015. Personal communication with ARPA Emilia-Romagna Agency – Piacenza Division – Environmental System Service
- [5] van Zelm R., Larrey-Lassale P., Roux P., "Bridging the gap between life cycle inventory and impact assessment for toxicological assessment of pesticides used in crop production". *Chemosphere* 100 (2014): 175-181
- [6] Rosenbaum RK, Bachmann TK, Gold LS, Huijbregts MAJ, Jolliet O, Juraske R, Koehler A, Larsen HF, MacLeod M, Margni M, McKone TE, Payet J, Schuhmacher M, Van de Meent D, Hauschild MZ.
- [7] "USEtox: The UNEP/SETAC-consensus model: recommended characterisation factors for human toxicity and freshwater ecotoxicity in life cycle impact assessment. *Int J Life Cycle Assess* 13 (2008):532–546.

# **Five crucial complicating issues for harmonising environmental footprints of food and beverages**

*Tommie Ponsioen<sup>1</sup>*

<sup>1</sup>*PRé Consultants, Stationsplein 121, 3181 LE Amersfoort, the Netherlands*

*E-mail contact: [ponsioen@pre-sustainability.com](mailto:ponsioen@pre-sustainability.com)*

## **1. Abstract**

*Several attempts have been made to harmonize the way environmental footprints of food and beverages are conducted. For example, the food SCP round table, the Leap partnership, and the Environmental Footprint project, in particular within the Cattle Model Working Group. Despite all the activities, there are still many issues unresolved. This paper gives an overview of the five most important reasons why it is so difficult to reach consensus within the sector and gives clear recommendations from the author's perspective. In short, the issues are: 1) how to allocate deforestation to land use activities; 2) how to measure an agricultural emissions profile; 3) how to make regionalized water scarcity assessments; 4) how to determine the functional unit of food and beverages; and 5) how to deal with multi-functional processes in agro-industry.*

## **2. Introduction**

Increasingly more attention is paid to environmental footprints of food and beverages. This can be observed by the increased number of publications on agricultural LCAs [1], the development of agricultural background inventory data, for example in the databases Agri-footprint [2], Agribalyse [3] and ecoinvent [4] databases, and initiatives to harmonize footprinting rules for food and beverages, such as the Food Sustainable Consumption and Production Round Table [5], the Leap partnership [6], and the Environmental Footprint Pilot Phase project [7], in particular within the Cattle Model Working Group. Despite all the activities, there are still many methodological and practical issues unresolved. This paper gives an overview of the five most important reasons why it is so difficult to reach consensus within the sector and gives clear recommendations from the author's perspective. In short, the issues are about: 1) how to allocate deforestation to land use activities; 2) how to measure an agricultural emissions profile; 3) how to make regionalized water scarcity assessments; 4) how to determine the functional unit of food and beverages; and 5) how to deal with multi-functional processes in agro-industry.

## **3. Complicating issues**

### **3.1. How to allocate deforestation to land use activities**

No one denies that forests are still being destroyed at an alarming rate with high impacts on biodiversity and climate change [8]. However, there is no straightforward method for allocating these burdens to agricultural products, because there is never a clear direct link between the transformation and agricultural activities. In the author's opinion, the issue should not be about how to amortize burdens of the past to current land use, but about what the consequences are of using an area of land for a specific purpose in a country. Many studies have discussed the topic in a consequential approach (e.g. [9]), but this involves a lot of arbitrary

assumptions. As a compromise, I recommend the method to calculate the amount of land use change caused by increased pressure from growing areas per crop in each country as developed by Ponsioen and Blonk [10]. In practice, it means that the average annual agricultural area increase at the cost of natural land over the past 20 years in a country is divided proportionally over the crops that have increased in area in that country during that period. This concept is applied in the PAS2050 [11] and recommended in the PEF and OEF Guides [12].

### **3.2. How to measure an agricultural emissions profile**

Agriculture is also linked to various harmful emissions, such as pesticides, ammonia, nitrogen oxides, nitrous oxide, and methane. Most of these emissions are a result of biological processes in the soil, crop or animal system. The issue is that they are extremely difficult to measure or to calculate with any reasonable precision. There are many equations and detailed calculation models available, all resulting in different outcomes [e.g. 13]. A possible consequence is that having more detailed calculations may result in a larger footprint, which is not motivating companies to invest in additional efforts for collecting the required data for these models. On the other hand, generalistic models do not always translate real improvement measures into smaller footprints. An example of this is the IPCC Guidelines [14] for calculating the methane emissions from dairy cows, where Tier 1 gives a default factor per cow, Tier 2 takes the animal's diet into account and Tier 3 is based on a detailed mechanistic model. The solution should be to allow the intermediate level of detail, because the lowest level of detail is generally too rough and a more detailed level may not be feasible in many cases due to lack of data, but there should be the option to add more detail.

### **3.3. How to make regionalized water scarcity assessments**

Water scarcity is increasingly being considered as an important impact category for environmental footprints and agriculture is by far the most water consuming sector [15]. To get meaningful impact results for water scarcity, specific regionalized water consumption data and spatially differentiated characterization is needed. The problem is that background databases do not give the required precision and software packages are, in general, not ready either. It is of crucial importance that the inventory data of irrigation and evapotranspiration rates for crop production are of good quality and that multiple years of production is considered. As a starting point, the inventory can be characterized using country specific factors as available in some LCA software packages. However, this level of detail can be problematic, especially in large countries, such as the United States [16]. More detailed characterization should therefore be allowed by footprinting protocols and tools are needed to standardize the procedure.

### **3.4. How to determine the functional unit of food and beverages**

Besides the diversity of environmental impacts, food and beverage products have a large spectrum of functionalities. Most people agree that food and beverages serve as a source of nutrition, such as protein, vitamins, minerals, fibres, etc., but there is no single indicator that captures each of these nutritional parameters. Moreover, there are also differences in taste, texture, and other subjective properties. As a consequence, the environmental footprints of food and beverages are difficult to compare on a completely fair basis.

One way to solve this problem is to expand the two product systems for comparison to complete diets where the nutritional values are the same. However, this involves again a lot of arbitrary assumptions that affect the results. The only practical solution that has been proposed is to report the footprints per currency unit [17]. This functional unit represents how the consumer values the different functionalities of the food or beverage and takes the possible rebound effects of spending saved money on other environmentally damaging activities into account.

### **3.5. How to deal with multi-functional processes in agro-industry**

Multi-functionality is very common in agricultural and agro-industrial processes. The consequential approach is possible by substituting the environmental burdens of products that would have been produced when no co-production took place, but leads to disagreement on the choices of substituted products. Physical allocation is also possible, but is not always perceived as fair either, especially when by-products receive a large share compared to the share based on economic allocation. Economic allocation, on the other hand, introduces a discussion on the prices to be used. Prices depend on the actual market situation, governmental policies, and on the relation between the producer and the buyer. Economic allocation may be the last option in the ISO hierarchy [18], but it is the least problematic when the co-products have such deviating functionalities as in the agro-industry. The prices should be based on public statistics when they are considered as representative. When it is not, stakeholders should define new price statistics that they can agree upon. It is also crucial to take multiple year price averages to level out fluctuations [19].

## **4. Conclusion**

In conclusion, the results of an environmental footprint of a food or beverage product highly depend on the level of detail and the choices made within the five topics discussed here. Clearly reporting these aspects, sensitivity analysis and careful interpretation are therefore crucial for taking the right conclusions. The author's recommendations are to: 1) use the method to calculate the amount of land use change caused by increased pressure from growing areas per crop in each country as proposed by Ponsioen and Blonk [10]; 2) calculate the agricultural emissions using an intermediate level of detail with the option to add more detail; 3) make sure the irrigation and evapotranspiration data is of good quality and characterize the inventory with country specific water scarcity factors or more detailed when needed; 4) report the footprint results in currency besides per unit of mass or volume to enable fairer comparisons; and 5) apply economic allocation based on realistic prices and take multiple year averages.

## **5 References**

- [1] PRé, 'Why Food Sustainability LCAs Make Up a Full 25% of All Published LCAs', <http://www.pre-sustainability.com/why-25-of-LCAs-are-agriculture-related>, (2014).
- [2] Agri-footprint, [www.agri-footprint.com](http://www.agri-footprint.com), (Blonk Consultants, Gouda, 2015).
- [3] Agribalyse, [www.ademe.fr](http://www.ademe.fr), (ADEME, Angers, 2015).
- [4] ecoinvent, [www.ecoinvent.org](http://www.ecoinvent.org), (the ecoinvent centre, Zürich, 2015).
- [5] Food SCP Round Table, [www.food-scp.eu](http://www.food-scp.eu).
- [6] FAO Leap partnership, <http://www.fao.org/partnerships/leap/en/>.
- [7] Environmental Footprint Pilot Phase, <http://ec.europa.eu/environment/eussd/smgp/index.htm>.

- [8] FAO, 'State of the World's Forests 2014, (FAO, Rome, 2014).
- [9] Searchinger, T., et al., 'Use of U.S. Croplands for Biofuels Increases Greenhouse Gases Through Emissions from Land-Use Change', *Science* 319 5867 (2008) 1238–1240.
- [10] Ponsioen, T.C. and Blonk, T.J., 'Calculating land use change in carbon footprints of agricultural products as an impact of current land use', *Journal of Cleaner Production* 28 (2012) 120-126.
- [11] BSI, 'PAS 2050-1:2012 Assessment of life cycle greenhouse gas emissions from horticultural products, Supplementary requirements for the cradle to gate stages of GHG assessments of horticultural products undertaken in accordance with PAS2050', (BSI, London, pp. 38, 2012).
- [12] European Commission, 'Commission Recommendation of 9 April 2013 on the use of common methods to measure and communicate the life cycle environmental performance of products and organisations', *Off J Eur Union* 56 (2013).
- [13] Kros, H., Lesschen, J.P., Bannink, A., Kuikman, P., and Oenema, O., 'Review on calculation methodologies and improvement of mechanistic modelling of GHG emissions', DLO, Wageningen, 2012).
- [14] IPCC (2006), '2006 IPCC Guidelines for National Greenhouse Gas Inventories, Volume 4: Agriculture, Forestry and Other Land Use', Eggleston H.S., Buendia L., Miwa K., Ngara T. and Tanabe K. (Eds.), (Institute for Global Environmental Strategies (IGES), Japan. ISBN 4-88788-032-4, 2006).
- [15] FAO, [www.fao.org/nr/aquastat/](http://www.fao.org/nr/aquastat/), (FAO, Rome, 2015).
- [16] Mutel C.L., Pfister S., Hellweg S. 'GIS-based regionalized life cycle assessment: how big is small enough?', *Methodology and case study of electricity generation*, *Environ. Sci. Technol.* 46 (2012), 1096–1103.
- [17] Thiesen, J., Christensen, T.S., Kristensen, T.G., Andersen, R.D., Brunoe, B., Gregersen, T.K., Thrane, M. & Weidema, B.P. 'Rebound Effects of Price Differences' *International Journal of Life Cycle Assessment* 13 2 (2008) 104-114., 10.1065/lca2006.12.297
- [18] ISO 14044:2006, 'Environmental management-Life cycle assessment-Requirements and guidelines', (International Standards Organization, Geneva, 2006).
- [19] Blonk, H., and Ponsioen, T. 'Towards a tool for assessing carbon footprints of animal feed', (Blonk Milieu Advies, Gouda, 2009).



# Environmental impacts of different dairy farming systems in the Po Valley

Authors: (*Alessandro Agostini*<sup>1,2</sup>, *Ferdinando Battini*<sup>3</sup>, *Vincenzo Tabaglio*<sup>3</sup>, *Stefano Amaducci*<sup>3</sup>)

<sup>1</sup> *European Commission, Joint Research Center, Institute for Energy and Transport,  
Westerduinweg 3, 1755LE Petten, The Netherlands*

<sup>2</sup> *ENEA—Italian National Agency for New Technologies, Energy and the Environment,  
Via Anguillarese 301, Rome, Italy*

<sup>3</sup> *Department of Sustainable Crop Production, Università Cattolica del Sacro Cuore  
Via Emilia Parmense 84, 29122 Piacenza, Italy*

*E-mail contact: [alessandro.agostini@ec.europa.eu](mailto:alessandro.agostini@ec.europa.eu)*

## 1. Abstract

An environmental Life Cycle Assessment (LCA) was performed to compare four typical milk production systems of the Po Valley: drinking milk; Parmigiano-Reggiano more intensive; Parmigiano-Reggiano less intensive and Grana Padano. The results indicate that when LUC emissions from imported soybean meal were not included in the analysis, lower GHG emissions were associated to higher milk yield, feed self-sufficiency and feed efficiency. However, when LUC emissions were included in the analysis, an increase of these parameters did not always lead to a reduction of the total GHG emissions because the higher use of maize silage was associated to an increase in the use of imported soymeal. Marine eutrophication, freshwater eutrophication, non-renewable energy use and land occupation, decreased with the level of intensification of the production system. Biodiversity loss, instead, increased if the milk yield per cow increased. We conclude that the increase in productivity may cause trade-offs between global impacts and local impacts.

## 2. Introduction

The total GHG emissions from the livestock sector were estimated to be 7.1 Gt CO<sub>2</sub> eq. yr<sup>-1</sup> (14.5 % of all anthropogenic emissions), with cattle being the main contributor to the sector emissions, generating about 4.6 Gt CO<sub>2</sub> eq. 65 % of the livestock sector emissions [1]. A review of LCAs of milk production within the EU27 [2] showed that most studies set the system boundary at the farm gate and only few considered Land Use Change (LUC). Flysjö et al. [3] analysed the carbon footprint of milk and showed that different LUC accounting methods lead to significantly different results. Guerci et al. [4] found that the proportion of grassland in the farming system and the feed efficiency in the herd, were the parameters that influence the most the environmental impact. The objective of this study is to assess the environmental impact of milk production of four farms in the Po Valley. The impact categories analysed are: Climate Change, Acidification, Eutrophication, Non-renewable energy use, Land occupation and Biodiversity Damage. The aim is to identify the farming processes and characteristics that contribute the most to the environmental impact of milk production.

## 3. Materials and methods

We have analysed the environmental impact of the four different dairy farming systems with a Life Cycle Assessment (LCA) approach. LCA is widely acknowledged as the most suitable tool to assess the environmental impacts of a product or a process [5,6].

This LCA is performed using the software GaBi 6 from PE International [7]. The background data used are from the Ecoinvent database [8]. The functional unit is one kilogram of Fat and Protein Corrected Milk (FPCM) at farm gate. Figure 1 summarises the system boundaries of the systems analysed. Only vitamin supplements, medicines and bull semen are not included; however, their overall impacts are considered to be negligible. Meat is a co-product of milk in dairy farms, thus, the environmental impacts need to be allocated to the two co-products. In this study we have used a biological approach (based on feed energy required to produce milk and meat respectively) to discount the environmental impacts due to meat production, as described in [9].

### 3.1 Systems description

After a pre-evaluation, four farms belonging to the three target farming systems (two for Parmigiano-Reggiano and one for Grana Padano and drinking milk) were selected and questionnaires were distributed to the farmers to collect data. Farm A (drinking milk) is a very intensive farm with a high share of feed produced on farm, mainly maize and maize-ryegrass double-crop. The milk yield and the stocking rate are high. The roughage feed self-sufficiency (silage and hay) is 87.1%, while for concentrate feed is 44.9%. The permanent grassland and lucerne cover 18.7% of the agricultural area. In farm B (more intensive Parmigiano-Reggiano production system), the farm crop rotation is completely based on lucerne and other hay forage crops since silage use is not allowed. This farm is almost self-sufficient for fodders, but not for concentrate feed. Indeed, the hay self-sufficiency is 99.6%, while for concentrate feed is 0%. Farm C (less intensive Parmigiano-Reggiano system) is representative of farming systems of smaller size and lower efficiency.

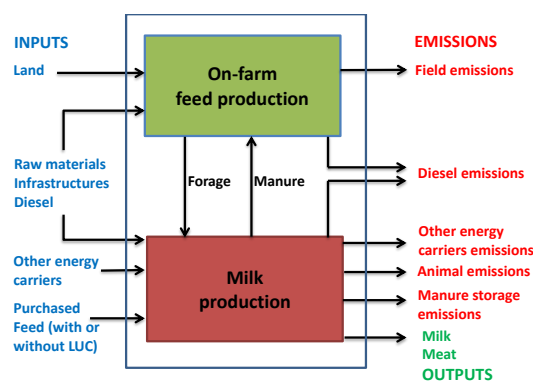

Figure 1: The system boundaries used in this study

In this case the farmland is primarily used for the production of hay (83% of the farm area is dedicated to forage crops, mainly lucerne) while cereal grains for feed is secondary. The hay self-sufficiency is 50.2%, while for concentrate feed it is 31.8%. The cows in this farm have lower milk yield than the more intensive ones. The stocking rate of the last two farms (B and C) is lower than that of farm A. Farm D has quite high milk yields and the stocking rate per hectare is high, but it does not reach the level of farm A. The self-sufficient for roughage feed is 82.6%, while for concentrate feed it is 0%.

#### 4. Results

The resulting flows of resources consumed and emissions crossing the system boundary were grouped and assessed, for the most relevant environmental areas of concerns, in order to understand and evaluate their magnitude and significance.

The analysed impact categories were: global warming, freshwater and marine eutrophication and acidification. The life cycle impact assessment was performed using the methods recommended by the ILCD Handbook [10].

The analysis included two technical quantities: primary energy from non-renewable resources and land use. In addition, the impact on biodiversity was assessed. The results are reported in Figure 2 and 3.

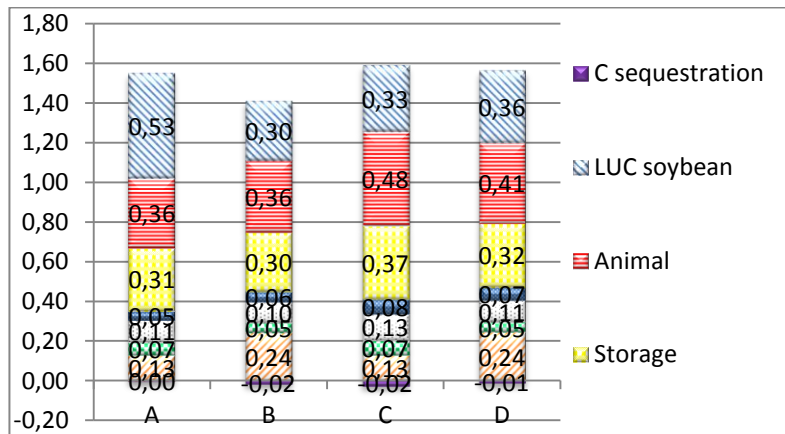

Figure 2: Process contribution analysis of the GHG emissions with LUC and C sequestration

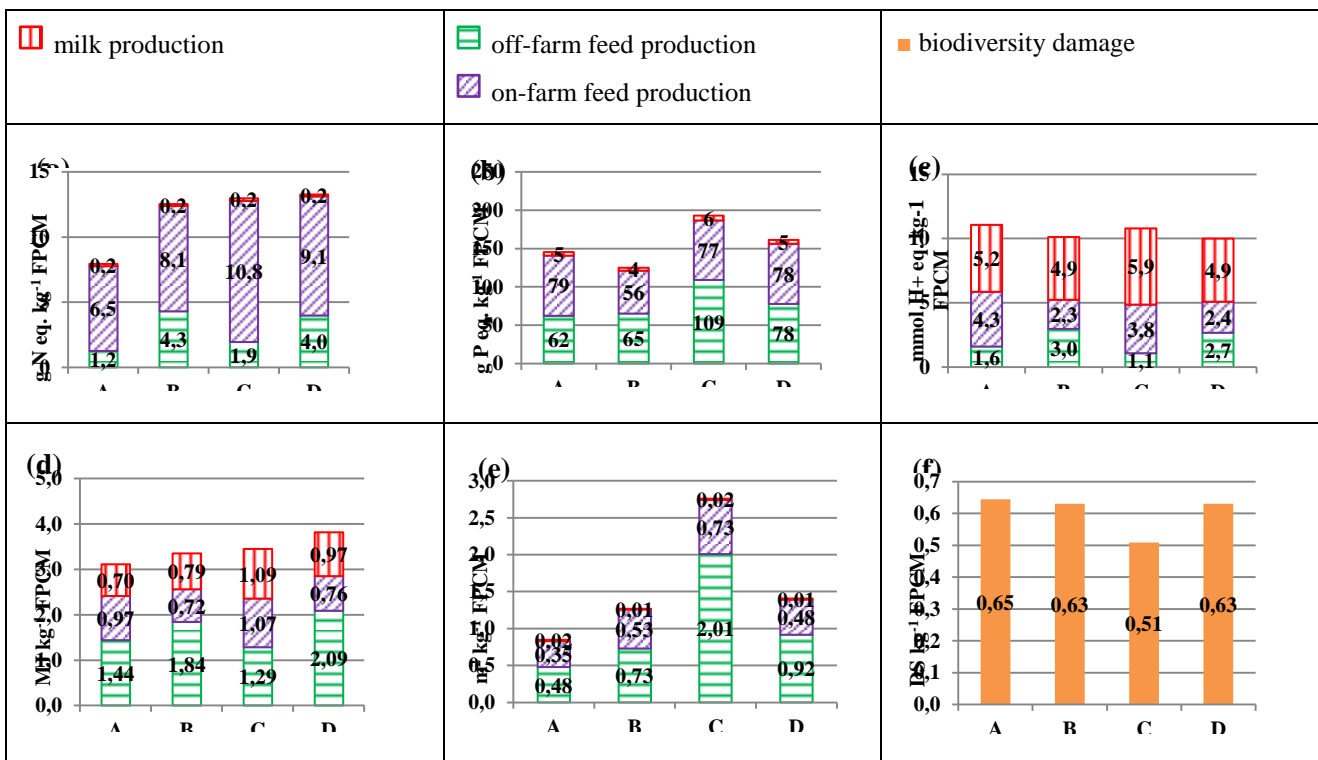

Figure 3: Process contribution for: (a) Marine Eutrophication; (b) Freshwater Eutrophication; (c) Acidification Potential; (d) Primary energy from non-renewable resources; (e) Land occupation; (f) Total biodiversity damage

## 5. Conclusions

Our results suggest that it is not possible to state what farming system has the lowest environmental impact because of the trade-offs among different areas of environmental concern.

With regard to climate change, it is concluded that, if carbon emission from LUC from imported soymeal are not accounted for, increasing milk yield, feed self-sufficiency and feed efficiency are effective strategies to lower GHG emissions. However, when LUC emissions are included in the analysis, these strategies, which lead to higher use of maize silage, cause an increase in the use of imported soymeal to compensate for the lower protein content. The additional use of soymeal practically compensate the GHG emission savings obtained with the above mentioned management strategies.

The increase in productivity causes also trade-off between global impacts (e.g. GHG emissions) and local impacts (e.g. biodiversity and eutrophication). When the eutrophying emissions are reported per kg FPCM, the more intensive farms have lower emissions. Eutrophication, however, depends on the intensity of the local emissions to the environment, and therefore a metric considering the areal intensity of the emissions may provide additional information. In fact, when reported per hectare, the eutrophying emissions (both N and P) result higher for the more intensive farms. Therefore, we recommend particular attention to the metric used for the assessment of the eutrophication in the interpretation of the results of LCAs of milk production to avoid misleading conclusions that do not take into account the local vulnerability to eutrophication.

Last but not least, for diverse systems, such as those compared in this study, the LCA must be applied at the level of the whole farm to fully understand and internalize the complex effects and interrelationships of the agricultural system. In particular, to avoid the environmental burden shift, all relevant environmental impacts shall be analyzed to evaluate the trade-offs among different environmental impact categories.

Furthermore, also the geographical shift of the environmental impacts has to be avoided expanding the system boundaries of the farms analysed to include the impacts of the feed production and LUC caused outside of the farms analysed.

## 5 References

- [1] Gerber, P.J., Steinfeld, H., Henderson, B., Mottet, A., Opio, C., Dijkman, J., Falcucci, A., Tempio, G. 2013. 'Tackling climate change through livestock – A global assessment of emissions and mitigation opportunities', Food and Agriculture Organization of the United Nations (FAO), Rome, <http://www.fao.org/3/a-i3437e/index.html>
- [2] Bellarby, J., Tirado, R., Leip, A., Weiss, F., Lesschen, J.P., Smith, P., 2013, 'Livestock greenhouse gas emissions and mitigation potential in Europe', *Glob. Change Biol.* 19, 3-18
- [3] Flysjö, A, Cederberg, C, Henriksson, M, Ledgard, S. 2012. 'The interaction between milk and beef production and emissions from land use change and critical considerations in life cycle assessment and carbon footprint studies of milk', *J. Clean. Prod.* 28, 134-142
- [4] Guerci, M., Trydeman Knudsen, M., Bava, L., Zucali, M., Schönbach, P., Kristensen, T., 2013b. Parameters affecting the environmental impact of a range of dairy farming systems in Denmark, Germany and Italy, *J. Clean. Prod.*, 54, 133-141

- [5] ISO, 2006a. Environmental Management – Life Cycle Assessment – Principles and Framework. EN ISO 14040, Brussels, Belgium.
- [6] Institute for Environment and Sustainability (IES), European Commission, Joint Research Centre, 2010. International Reference Life Cycle Data System (ILCD) Handbook, 'General guide for Life Cycle Assessment' Detailed guidance, first ed. Publications Office of the European Union, Luxembourg.
- [7] PE International. Gabi 6 [Software]. Leinfelden-Echterdingen, Germany: 2013; [www.pe-international.com](http://www.pe-international.com)
- [8] Ecoinvent, 2010. Ecoinvent Database v2.2. Swiss Centre for Life Cycle Inventories, Dübendorf, Switzerland.
- [9] International Dairy Federation (IDF), 2010. 'A common carbon footprint approach for dairy – The IDF guide to standard lifecycle assessment methodology for the dairy sector' Bulletin of the International Dairy Federation 445
- [10] Institute for Environment and Sustainability (IES), European Commission, Joint Research Centre, 2012, 'Characterisation factors of the ILCD Recommended Life Cycle Impact Assessment methods' Database and Supporting information, first ed., Publications Office of the European Union, Luxembourg

# The Product Environmental Footprint Category Rules (PEFCR)

## Packed Water Pilot Testing

Author(s): S. Pedrazzini<sup>1</sup>, V. Magaud<sup>1</sup>, S. Humbert<sup>1</sup>, P. Fosselard<sup>2</sup>, L. Struebbe<sup>2</sup>, F. Rivet<sup>3</sup>, R. Pavanello<sup>3</sup>, P. Peuch<sup>4</sup>, C. Van Den Dungen<sup>4</sup>, L. Verkinderen<sup>5</sup>, P. Diercxsens<sup>6</sup>, G. Dadà<sup>7</sup>, B. Pruvost<sup>8</sup>, A. de Schryver<sup>9</sup>, J.-B. Schrans<sup>9</sup>

<sup>1</sup>Quantis, EPFL Innovation Park, Bât. D, 1015 Lausanne, Switzerland. <sup>2</sup>European Federation of Bottled Waters (EFBW), Place des Barricades 1, 1000 Brussels, Belgium. <sup>3</sup>European Container Glass Federation (FEVE),

89 Avenue Louise, 1050 Brussels, Belgium. <sup>4</sup>PETcore Europe, Avenue de Cortenbergh 71, 1000 Brussels, Belgium.

<sup>5</sup>Union Européenne des Transporteurs Routiers (UETR), Joseph II straat 36-38, p/a ISB Box 2, 1000 Brussels, Belgium.

<sup>6</sup>Danone Waters, 17 Boulevard Haussmann, 75009 Paris, France. <sup>7</sup>Ferrarelle, Contrada Ferrarelle, 81053 Riardo, Italy. <sup>8</sup>Nestlé Waters, 12 Bd Garibaldi, 92130 Issy Les Moulineaux, France.

<sup>9</sup>Spadel, Rue Colonel Bourg 103, 1030 Schaarbeek, Belgium.

E-mail contact: [simone.pedrazzini@quantis-intl.com](mailto:simone.pedrazzini@quantis-intl.com)

### 1. Abstract

*In 2014, the European Commission selected the packed water sector for the Product Environmental Footprint Category Rules (PEFCR) pilot testing. The Technical Secretariat which is responsible for developing the PEFCR for packed water by end of 2016, is composed of four federations: the European Federation of Bottled Waters (EFBW), the European Container Glass Federation (FEVE), Petcore Europe, the European PET industry association, and the Union Européenne des Transporteurs Routiers (UETR); four natural mineral water producers: Danone Waters, Ferrarelle, Nestlé Waters and Spadel; and one Life Cycle Assessment (LCA) consultant: Quantis. The first outputs of the on-going project will be presented mainly based on official deliverables, e.g., definition of PEF product category and scope of the PEFCR; definition of the product “model” based on representative products; PEF screening and draft PEFCR.*

Note: San Benedetto officially joined the Technical Secretariat since July 2015

### 2. Introduction

On April 9<sup>th</sup> 2013, the European Commission published a “Communication from the Commission to the European Parliament and the Council: Building the Single Market for Green Products, facilitating better information on the environmental performance of products and organisations” [1].

An open call for volunteers was announced by the European Commission for the Product Environmental Footprint (PEF) and the Organisation Environmental Footprint (OEF), inviting companies, industrial and stakeholder organisations without geographical restriction to participate in the development of product-group specific and sector-specific rules. 120 applications were submitted by food and non-food sectors. Twenty-five PEF projects were selected amongst which the pilot project for Packed Water. The Technical Secretariat [2] which is responsible for developing the Product Environmental Footprint Category Rules (PEFCR) for Packed Water by the end of 2016 (officially launched in July 2014), is composed of four federations: the European Federation of Bottled Waters (EFBW), the European Container Glass Federation (FEVE), Petcore Europe, and the Union Européenne des Transporteurs Routiers (UETR); four natural mineral water

producers: Danone Waters, Ferrarelle, Nestlé Waters and Spadel; and one Life Cycle Assessment (LCA) consultant: Quantis.

### **3. Materials and methods**

According to the European Commission, the objectives of the pilot phase are: i) to set up and validate the process of the development of product group-specific rules; ii) to test different compliance and verification systems, in order to set up and validate proportionate, effective and efficient compliance and verification systems; and iii) to test different business-to-business and business-to-consumer communication vehicles for Environmental Footprint information in collaboration with stakeholders.

The following steps shall be followed when preparing a PEFCR: i) definition of PEF product category and scope of the PEFCR; ii) definition of the product “model” based on representative product(s); iii) PEF screening; iv) draft PEFCR; v) PEFCR supporting studies by Nestlé Waters, Danone and Ferrarelle in order to test the draft PEFCR with concrete case studies; vi) confirmation of benchmark(s) and determination of performance classes; vii) final PEFCR.

### **4. Results**

As first concrete deliverable, the Technical Secretariat of the pilot defined the scope of the PEFCR. The main function of the product is to provide water from sealed containers ready to be drunk (“at the mouth”). Some alternative applications are present on the market which correspond to the main three sub-categories listed here: the “at horeca” application considers formats mainly used at a hotel, restaurant or café; the “at the office” application considers formats mainly used within a professional context; and “other channels” applications which include the “on the go” application (characterised by an easily transportable and useable format, easy opening and with a rather small format adapted to one single drinker) and the “at home” application (characterised by formats mainly used within a domestic context). The product category for this PEFCR is packed water which includes the full life cycle (cradle to grave) of a packed water serving sold in any market and intended for end-consumers for the three sub-categories of application mentioned above. Thus, one screening study has been conducted for each of these sub-categories using a specific product for each sub-category. The data used for each representative product were determined partly based on primary data from packed water manufacturers, existing sector guidance and European market statistics. The results of the screening studies will be publicly available by the date of the conference (the launch of the public consultation on the screening studies is foreseen by end of June 2015).

The screening results will be presented according to the default Environmental Footprint (EF) impact category indicators from the PEF/OEF recommended method. This multi-indicator approach allows covering a wide range of potential impact categories. They correspond to the ILCD method [3] version 1.04 (ILCD 2011 Midpoint+ (for use in PEF/OEF pilots) as available in the SimaPro software):

- Climate change
- Ozone depletion
- Human toxicity, cancer effects
- Human toxicity, non-cancer effects
- Particulate matter
- Ionizing radiation HH
- Ionizing radiation E (interim)
- Photochemical ozone formation
- Acidification
- Terrestrial eutrophication
- Freshwater eutrophication
- Marine eutrophication
- Freshwater ecotoxicity
- Land use
- Water resource depletion
- Mineral, fossil & renewable resource depletion

## **5. Conclusion**

The first outputs of the on-going project will be presented mainly based on official deliverables, e.g., definition of PEF product category and scope of the PEF CR; definition of the product “model” based on representative products; PEF screening and draft PEF CR.

## **6. References**

- [1] <http://ec.europa.eu/environment/eussd/smgp/>
- [2] [http://ec.europa.eu/environment/eussd/smgp/pdf/Fiche\\_packed\\_water.pdf](http://ec.europa.eu/environment/eussd/smgp/pdf/Fiche_packed_water.pdf)
- [3] European Commission - Joint Research Centre - Institute for Environment and Sustainability (2011).
- [4] International Reference Life Cycle Data System (ILCD) Handbook - Recommendations for Life Cycle Assessment in the European context - based on existing environmental impact assessment models and factors. ISBN 978-92-79-17451-3, doi: 10.278/33030. Publications Office of the European Union, Luxembourg.



# **Identification of the most relevant impact categories with normalisation and equal weighting methods: inconsistencies found in raw milk case study**

*Simona Scalbi, Valentina Fantin, Patrizia Buttol, Paolo Masoni*

*ENEA (Italian National Agency for New Technologies, Energy and Sustainable Economic Development),*

*Via Martiri di Monte Sole 4, 40129 Bologna, Italy*

*E-mail contact: simona.scalbi@enea.it*

## **1. Abstract**

*The goal of this paper is to discuss bias issues occurring when different normalisation and equal weighting methods are used to identify the most relevant impact categories for raw milk production chains. Twelve Italian farms were investigated, six producing cow milk and six producing buffalo milk. Productivity and milk characteristics of buffaloes and cattle are different, but the production systems of the farms are similar. The functional unit for all Life Cycle Assessment (LCA) studies was 1 kg of raw milk; system boundaries were from cradle to farm gate, and included fodder production, energy and water consumption, waste and airborne and waterborne emissions at farms. The normalised results obtained with the CML, the Recipe and the PEF methods have been compared. Problems regarding robustness of normalization methods have been discussed.*

## **2. Introduction**

According to ISO 14044, normalisation is the calculation of the magnitude of the impact category results relative to some reference information and is aimed at better understanding their relative significance for a specific product. Normalization can be performed by means of a reference (external normalization) or by a baseline (internal normalization). A reference system for external normalisation can be chosen on system basis (e.g. a region, an economic sector), spatial scaling (e.g. nation, continent), temporal scaling (e.g. per year) and additional magnitude scaling (e.g. per capita). Regionally defined reference values, based on geographically restricted areas, are most commonly used by the LCA community. Methods such as ReCiPe, IMPACT 2002+, TRACI, and Eco-indicator apply an external normalization. In case of internal normalisation, data from alternative product systems are referenced to each other. The use of normalized values to rank impact categories always implies the assumption that all environmental problems are equally significant. Since the differences of reference systems influence the interpretation of normalised LCIA results [1], problems can arise when LCA is used to support decisions. This paper aims to highlight some bias issues occurring when different normalisation and equal weighting methods are used to identify the most relevant impact categories for raw milk production chains. The comparison is performed by using the CML, Recipe and PEF (Product Environmental Footprint) methods. Both CML and ReCiPe impact assessment methods use the inventory of emissions into air, water, soil and resources extraction in EU25+3 in 2000. The PEF method uses data in the EU-27 territory in 2010 [2].

### 3. Method

Twelve Italian farms were involved in the study, six producing buffalo milk and six producing cow milk. Buffaloes and cattle differ for productivity and milk characteristics, but the production systems of the farms investigated are similar and include rearing in confined systems with need for considerable amounts of concentrates, fossil fuels and chemicals. The functional unit for all Life Cycle Assessment (LCA) studies was 1 kg of raw milk; system boundaries were from cradle to farm gate, including crops cultivation for fodder production, production and transport of purchased feed and concentrated, pesticides and chemical fertilisers used at farms, diesel, electricity and water consumption, production of waste, management and agronomic use of slurry and manure produced. The normalisation values were calculated as the weighted arithmetic mean on the basis of the milk productivity for each buffalo and cow farm. The standard deviation of the mean was calculated according to the following formula:

$$\sigma_{\bar{x}} = \frac{\sigma_x}{\sqrt{N}} = \frac{1}{\sqrt{N}} \sqrt{\frac{1}{N-1} \sum_{i=1}^N (x_i - \bar{x})^2}$$

### 4. Results

Figure 1 shows the average results of normalisation for both buffalo and cow production chains, obtained with the CML, the Recipe and the PEF methods. The buffalo milk results are higher because of the lower milk productivity of buffalo if compared with cow. The CML method identifies the following most relevant categories: Marine Aquatic Ecotoxicity, Acidification, Freshwater Aquatic Ecotoxicity, and Eutrophication. The most relevant categories for Recipe are: Marine Eutrophication, Terrestrial Acidification, Natural Land Transformation. The ranking of the impact categories according to PEF method is different for buffalo and cow milk. In particular, the most significant categories for cow milk production are: Terrestrial Eutrophication, Marine Eutrophication, Acidification, Freshwater Ecotoxicity, Human Toxicity cancer and non-cancer. The relevant impact categories identified for buffalo milk production are: Acidification, Terrestrial Eutrophication, Human Toxicity cancer and non-cancer, followed by Marine Eutrophication and Freshwater Ecotoxicity. In both PEF and Recipe methods Marine Eutrophication is more relevant in the buffaloes farms than in the cattle ones. This category is mainly affected by nitrate waterborne emissions from manure spreading, and differences are due to manure storage in the two production chains as well as to the ratio of the characterisation factors nitrate /ammonia (about 2.5). In the CML method the relevance of the Eutrophication category is almost the same in buffaloes and cow farms, because this category is much more affected by ammonia emissions, due to the ratio of the characterisation factors nitrate/ammonia (about 0.3). Inconsistencies were observed between buffalo and cow production chains also in the Toxicity categories of the PEF method, in particular for Freshwater Ecotoxicity. A slightly larger use of terbuthylazin, an active ingredient contained in pesticides, in the buffalo farms than in the cow farms and a high characterisation factor for this substance can explain the differences of relevance of this impact category in the two production chains. This difference cannot be observed in the CML method because it lacks the characterisation factor of this substance.

If the results are analysed without including the toxicity impacts, Acidification and Eutrophication stand out as the most significant impact categories for all methods in both production chains. They are mainly affected by ammonia and nitrate emissions coming from storage and use of manure and from the use of chemical fertilisers. All the other categories contribute less than 10% to the total impacts, excepting land transformation in Recipe, which contributes up to about 16%.

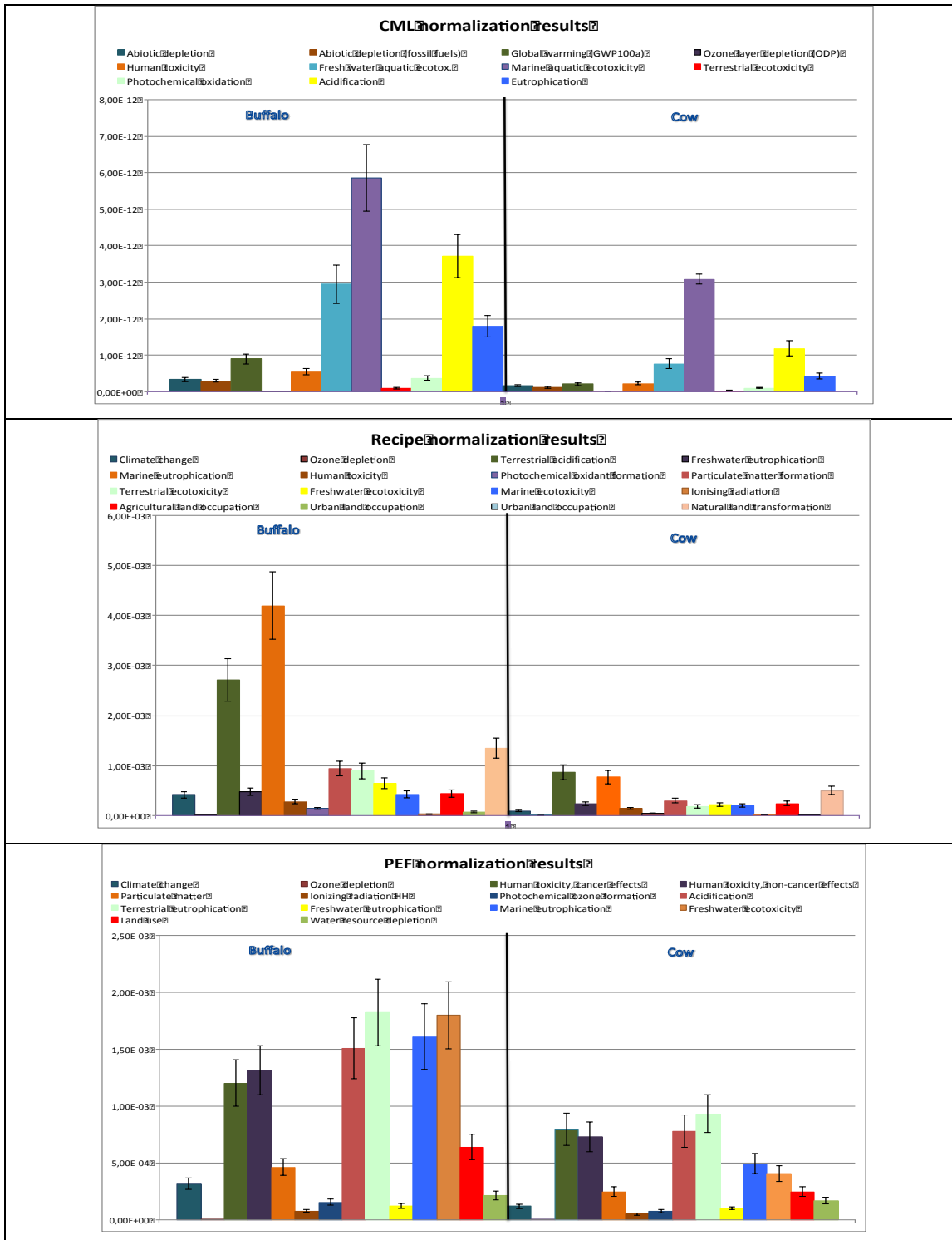

Figure 1: Normalisation results for 1 kg raw milk with the methods CML, Recipe and PEF

## 5. Discussion and conclusion

The normalisation methods analysed are quite different in terms of impact categories, reference units, impact factors and inventory of the reference systems. The results confirm that the choice of the normalisation method affects the interpretation of the significance of the impact categories. This means that the communication of the normalised results by the LCA practitioner should be very careful: it should be clearly stated that normalisation can be used to relate the LCIA results to a context, but not to judge the relative harmfulness of the impact categories. Moreover interpretation of the normalised results should include a discussion in terms of flows and processes that most contribute to the total impacts, as also the PEF documents recommend. Inconsistencies between the results of the two production chains have been observed especially for toxicity impact categories, which are known to be affected by low robustness [2]. The uncertainty that affects normalisation is particularly high for toxicity categories and is due to incompleteness of data of inventory for the reference system and lack of characterisation factors [3].

An analysis of the methods to weigh impact categories in LCA studies is out of the scope of this paper, but the observed results highlight that interpretation is a tricky issue that could be better addressed with a participatory approach, where interested parties of a product chain work together in accordance with their expertise and different roles in the decision making process.

## 6. References

- [1] Dahlbo, H., Koskela, S., Pihkola, H., Nors, M., Federley, M. and Seppala, J., 'Comparison of different normalised LCIA results and their feasibility in communication' *International Journal of Life Cycle Assessment*, 18 (4) (2013) 850-860.
- [2] Benini L., Mancini L., Sala S., Manfredi S., Schau E. M., Pant R., "Normalisation method and data for Environmental Footprints", Luxembourg: Publications Office of the European Union, 2014, ISBN 978-92-79-40847-2, ISSN 1831-9424, doi: 10.2788/16415
- [3] Van Hoof G., Vieira M., Gausman M. Weisbrod A., Received: 2013. Indicator selection in life cycle assessment to enable decision making: issues and solutions. *Int J Life Cycle Assess* (2013) 18:1568–1580.

# Inventories and database for LCA and footprint of food chains

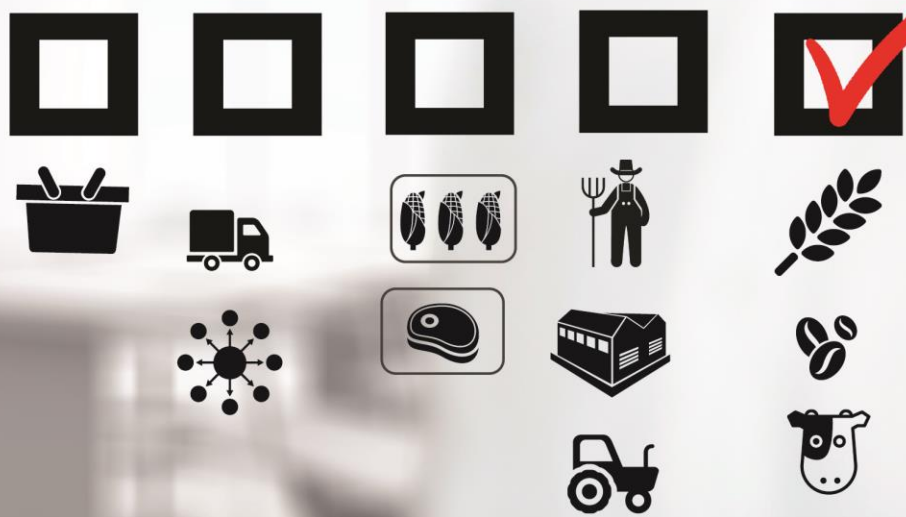

# Life Cycle Inventory database for seafood products

Omont Sophie<sup>1</sup>, Beutin Catherine<sup>2</sup>, and Payet Jérôme<sup>3</sup>

<sup>1</sup>Cycleco, 18 avenue Roger Salengro, 01500 Ambérieu-en-Bugey, France

<sup>2</sup>Pôle Aquimer, 16 rue du Commandant Charcot, 62200 Boulogne-sur-Mer France

<sup>3</sup>IES, Ecole Polytechnique Fédérale de Lausanne, DGR-EPFL 1015 Lausanne

E-mail contact: [sophie.omont@cycleco.eu](mailto:sophie.omont@cycleco.eu)

## 1. Abstract

*Food processing industries, especially those processing seafood products, often face difficulties when performing the Life Cycle Assessment (LCA) of their products due to a lack of sector-specific Life Cycle Inventories (LCI) in the reference LCI databases. In order to overcome this issue, Cycleco has developed an LCI database specific to agri-food and seafood products processing, in compliance with the International Reference Life Cycle Data System (ILCD) requirements. The LCI database was developed using skills acquired during ecodesign and product environmental labelling projects<sup>1</sup> involving agri-food and seafood sectors players. In the future it will be enriched with LCI datasets of seafood from catch and aquaculture, in a way that is consistent with the Product Environmental Footprint (PEF) pilot relating to Fish for human consumption [1].*

## 2. Introduction

Life Cycle Assessment (LCA) is the reference method for ecolabelling and product environmental footprinting. It is also a relevant decision support tool for ecodesign. However, as noticed during the FishAvniR<sup>2</sup> prospective study, seafood processing industries often face difficulties when performing the environmental assessment of their products due to a lack of sector-specific LCIs, both in the reference LCI databases (ecoinvent v3, European reference Life Cycle Database (ELCD), IMPACTS® database) and in the sectorial ones (LCA Food DK and Agri-footprint database). The lack of high quality LCI data on seafood production systems is also highlighted in the frame of the Product Environmental Footprint launched by the European Commission [1]. In order to overcome this issue, seafood processing industries need a sectorial LCI database.

## 3. Development of LCIs for seafood products

The Life Cycle Inventory (LCI) of a system (i.e. product, processes or service) quantifies the elementary flows (or substances) directly removed from the environment or directly released into the environment by the system. It is required to perform the life cycle impact assessment of the system. An LCI database is composed of LCI datasets of generic products and processes. The developed datasets are intended to form a generic LCI database on seafood products and are compliant with the “ILCD Entry Level” requirements, in

---

<sup>1</sup> Among these projects: FishavniR and Aquaconception, supported by Nord Pas de Calais’s (NPdC) Regional Council and ADEME (French Environment and Energy Management Agency), piloted by the French LCA platform [avniR], the French competitiveness cluster Aquimer and the Nouvelles vagues innovation platform.

<sup>2</sup> A strategic study aims to evaluate the seafood sector maturity and to improve the LCA practices and ecodesign applied to this sector.

terms of data collection, nomenclature of elementary flows, documentation, assessment and review of datasets.

#### **4. ILCD “Entry Level” requirements**

##### *4.1 Method*

Compliance of data with the ISO 14040 and 14044 methodology is required. Compliance with the methodological requirements of the ILCD is not mandatory, but any deviation from the method (e.g. allocation or substitution) has to be specified and documented.

##### *4.2 Nomenclature of elementary flows*

The elementary flows nomenclature has to be compliant with the ILCD reference elementary flows [2]. Consequently, LCI must be converted from its original format into ILCD format. This conversion is based on matching elementary flows in their original format with those in ILCD format.

##### *4.3 Documentation of LCI*

The documentation must be written in the ILCD format [3]. The most convenient way to do that is to use the ILCD editor. This documentation is divided in four main sections (as detailed below) and is linked to several sub-documentations, for example the sources, the system's diagram or the contact names.

- Process information, containing the Universally Unique IDentifier (UUID), the name, the classifications, the different representativeness descriptions and a flows diagram.
- Modeling and validation, containing among others the LCI method and allocations, the data selection and combination process, the data sources, the sampling procedure and all information about the validation.
- Administrative information, containing mainly the names of the data commissioner, data modeler and the origin of the data before conversion.
- Inputs and outputs, containing all the flows entering and leaving the system.

##### *4.4 Review*

A critical review report must be performed by an independent reviewer who knows the relevant sector as well as the process or product described in the dataset and who is an expert in LCA method. The reviewer can be either external or internal. In both cases, the review has to be documented in the ILCD dataset but additionally in the second case a critical review report must be attached as a source.

#### **5. Case study of salmon**

Cycleco has developed ILCD “Entry Level” datasets specific to agri-food and seafood products processing. Their development is based on the following steps.

##### *5.1 Functional unit*

The functional unit of each LCI is defined through the four following aspects: 1) provided function (what?), 2) size of the function (how much?), 3) quality of the function (how?), 4) duration of the function (how long?). As an example the functional unit of a freezing process can be described as: “Freeze 1kg of filleted fish at -20 °C during 5 years” (equipment life span).

## 5.2 Data collection

Data collection applies to quantitative data of all relevant inputs and outputs that are associated to the dataset. Data collection mainly concerns foreground data like product flows, energy, water and waste flows. For each LCI these data are respectively collected from: specific measurements and/or bibliographic reliable sources and/or calculation and/or expert contributions.

## 5.3 Life Cycle Inventory Modeling

Life Cycle Inventory is obtained using a LCA software, a generic LCI database and the collected data. LCI quantifies the elementary flows and their receiving/providing environmental compartments. The LCI obtained are converted into the ILCD format. The result depends on the choices made for the mapping and relies on Cycleco's expertise.

## 5.4 Documentation and review

The documentation is written in the ILCD format using the ILCD editor, and the critical review report is performed by an internal reviewer. Data quality is assessed in the frame of this internal review.

## 5.5 Examples of LCIs

Table 1: Examples of LCI

Datasets of products	Datasets of processes
Farmed salmon	Slaughter
Eviscerated salmon	Filleting
Salmon fillet	Quick-freezing
Deep frozen salmon filet	Storage (-20 °C)
Ground salmon	Storage (+4 °C)

s

## 6. Upcoming datasets

The current database will be shortly completed with LCI datasets of seafood from several fishing and aquaculture techniques by a consortium mainly based in the Nord-Pas-de Calais area. A primary range of datasets has been defined. It is composed of seafood products and processes which are economically and technologically representative of the Nord-Pas de Calais area. The geographical representiveness of these primary datasets will be extended based on bibliographical data.

### 6.1 Primary list of coming LCIs

Table 2: Primary list of upcoming LCIs

Datasets of products	Datasets of processes
Sea bass, <i>Dicentrarchus labrax</i> , from aquaculture and fishery	Filleting
Gilthead seabream, <i>Sparus aurata</i> , from aquaculture	Salting
Common sole, <i>Solea solea</i> , from fishery	Smocking
Saithe, <i>Pollachius virens</i> , from fishery	Seafood packing
Whiting, <i>Merlangius merlangus</i> , from fishery	
Atlantic mackerel, <i>Scomber scombrus</i> , from fishery	



## 6.2 LCIs building calendar

The project duration will be three years. The planning of the project includes the tasks listed below:

- Transfer of LCI building skills from Cycleco to other partners;
- Bibliographical state of the art ;
- Field-based data collection from seafood production actors (fishery, aquaculture and processing industry);
- LCIs modelling;
- LCIs documentation and review.

## 7. Conclusion

This database constitutes the first step of a complete database on seafood production systems. It will be enriched with LCI datasets of seafood from catch and aquaculture in the near future, by a consortium composed of the Université du Littoral Côte d'Opale, the French aquaculture and seafood cluster AQUIMER, and the independent consulting office specialized in ecodesign and LCA studies Cycleco. Besides, the ADEME AGRIBALYSE II committee informed in 2014 that it could be interesting to increase the fishing sector knowledge. Consequently, some French fishing organizations showed their interest in working on the durability of seafood products through the LCA approach and presented a scientific and technical program to ADEME. Finally, France proposed to the “fisheries and aquaculture” ISO technical committee a new item which aim is to facilitate the identification of products from sustainable marine fisheries having little requirements to comply with.

## 8. References

- [1] Erik Skontorp Hognes SINTEF, 'PEFCR Fish for human consumption Pilot - Goal and scope description', European Commission (Submitted to Steering Com. version, 2015)
- [2] European Commission - Joint Research Centre - Institute for Environment and Sustainability: International Reference Life Cycle Data System (ILCD) Handbook - Nomenclature and other conventions. First edition 2010. EUR 24384 EN. Luxembourg. Publications Office of the European Union; (2010)
- [3] European Commission - Joint Research Centre - Institute for Environment and Sustainability: International Reference Life Cycle Data System (ILCD) - Documentation of LCA data sets. Version 1, 2010. EUR 24381 EN. Luxembourg. Publications Office of the European Union, (2010)
- [4] European Commission - Joint Research Centre - Institute for Environment and Sustainability: International Reference Life Cycle Data System (ILCD) Data Network – Compliance rules and entry-level requirements. Version 1.1, 2012. EUR 24380 EN. Luxembourg. Publications Office of the European Union, (2012)

## The World Food LCA Database: a global inventory database for the food sector

Xavier Bengoa<sup>1</sup>, Jens Lansche<sup>2</sup>, Cécile Guignard<sup>1</sup>, Sébastien Humbert<sup>1</sup>, Violaine Magaud<sup>1</sup>, Patrik Mouron<sup>2</sup>, Thomas Nemecek<sup>2</sup>, Laura Peano<sup>1</sup>, Simone Pedrazzini<sup>1</sup>, Eliane Riedener<sup>1</sup>, Vincent Rossi<sup>1</sup>, Marcial Vargas<sup>3</sup>, Gérard Gaillard<sup>2</sup> and Arnaud Dauriat<sup>1</sup>

<sup>1</sup>Quantis, EPFL Innovation Park, Bât. D, 1015 Lausanne, Switzerland

<sup>2</sup>Agroscope, Institute for Sustainability Sciences ISS, Reckenholzstrasse 191, 8046 Zurich, Switzerland

<sup>3</sup>Quantis France, 42 boulevard Sébastopol, 75003 Paris, France

E-mail contact: [laura.peano@quantis-intl.com](mailto:laura.peano@quantis-intl.com)

### 1. Abstract

*The World Food LCA Database (WFLDB) provides over 350 unit processes and complete inventories for 50 different products and 40 countries, as well as global averages based on the relative shares of main exporting markets. It relies on peer reviewed methodological guidelines that are, to the extent possible, compatible with existing standards and ongoing global initiatives. A unique approach combining statistical data from FAO and agronomic extrapolations was developed to generate consistent LCI data at national level for all types of crops. The outcome is a fully documented LCI database compatible with all usual LCA software and data formats. The WFLDB aims to create a strong basis to assist companies and authorities within environmental assessments, product eco-design, supply chain management, Products Environmental Footprint or Environmental Product Declarations (EPD).*

### 2. Introduction

Agricultural production and food processing contribute significantly to environmental impacts on global warming, eutrophication and acidification ([1], [2], [3]). The use of LCA for the assessment of these impacts is steadily increasing in the last decade ([4]). However, major limitations to such assessments are the lack of reliable and consistent inventory data.

Existing libraries of LCA data on food products are most often: i) not transparent enough; ii) incomplete: only few inventory flows are accounted for, which leads to an incomplete overview of the impacts of food products and misleading interpretations and conclusions; iii) inconsistent among each other, due to different approaches and assumptions; iv) outdated and consequently unreliable; v) not regionalized: country-specific data are rarely available.

Therefore, it is critical to develop detailed, transparent, well-documented and reliable data to allow for more accurate and comparable LCA in the food sector.

In this context, Quantis and Agroscope launched early 2012 the World Food LCA Database (WFLDB) project which will be completed at the end of 2015, in collaboration with ADEME, Bayer CropScience, the Swiss Federal Office for the Environment, General Mills, Kraft Foods, Mars, Mondelēz International, Monsanto, Nestlé, PepsiCo, Syngenta and Yara. The main aim of the WFLDB is to create a basis to assist companies and environmental authorities to assess and reduce (“eco-design”) the impacts of food and

beverage products, in initiatives like Environmental Product Declarations (EPD) or product labelling, as well as serving academic research.

### **3. The methodology**

A new set of food inventory data is being developed from existing LCA studies on food products (previous assessments from project partners, existing databases from Agroscope and Quantis), literature reviews, statistical databases of governmental and international organizations (such as the Food and Agriculture Organization of the United Nations), environmental reports from private companies, technical reports on food and agriculture, information on production processes provided by the project partners as well as primary data. The developed datasets include regional specificities and impact from land use change, notably deforestation.

For full transparency, the underlying methodology is made public, the database is wholly documented, all sources are referenced and all datasets are provided as unit processes. The end-user is therefore able to differentiate among different stages of the product system (e.g. agricultural production vs. food product manufacturing) and to identify the main impact contributors (e.g. pesticides, fertilizer use, etc.).

Datasets created within the project are initially solely available to the project partners but all will progressively become public starting from 2016.

WFLDB relies on peer reviewed methodological guidelines that are, to the extent possible, compatible with existing standards and ongoing global initiatives, such as: i) theecoinvent data quality guidelines ([5]); ii) ISO 14040 and 14044 ([6], [7]); iii) the ILCD entry level requirements ([8]); iv) the PEF initiative ([9]); v) the LEAP partnership ([10] [11] [12]).

A first version of the WFLDB methodological guidelines was made public in August 2014 ([13]) and an updated version will be published in August 2015 ([14]). These guidelines provide modeling rules for all life cycle stages, from farming activities to food preparation. All key environmental flows are assessed in the inventory, such as greenhouse gas emissions, other emissions to air, soil and water, land use change (including deforestation and peat drainage), water use and heavy metal uptake and release. Furthermore, continuous effort is made to follow the developments within other international initiatives and organizations such as The Sustainability Consortium (TSC), the Food and Agriculture Organization of the United Nations (FAO), the Sustainable Agriculture Initiative Platform (SAI), the EU Food SCP Roundtable, the EU Product Environmental Footprint (PEF) and the International Dairy Federation ([15]). Scientific guidelines used in other database initiatives such as AGRIBALYSE ([16]) and ACYVIA ([17]) are also considered for the definition of the WFLDB modelling principles (developments are considered as they occur).

The advisory board of the WFLDB, constituted of non-governmental organizations and research institutes, provides the necessary external insight on the project governance and its integration in broader environmental and political initiatives. Its role is however purely consultative and its members do not formally endorse decisions made by the project leaders.

### 3.1 WFLDB coverage of food commodities

The WFLDB includes close to 400 datasets for fertilisers, arable crops, vegetables, fruits, berries, nuts, dairy products, animal products at the farm and co-products from slaughter, oils, processed food, food storage and home cooking. Over 500 additional sub-datasets are also developed for irrigation systems, animal feed, seeds and seedlings, infrastructure, machinery and appliances. Datasets represent typical, conventional, production systems in over 40 countries from all continents. Specific agricultural systems such as organic or integrated production are not yet available but could be part of a future evolution of the WFLDB. Global averages are calculated based on the respective export shares of the different countries covered for each product, with minimum 50% of the world export being systematically covered.

The WFLDB datasets are delivered in the most widely used data exchange formats for LCA software (i.e. ecospold v1, ecospold v2, SimaPro-CSV, Quantis SUITE 2.0-excel). This will enable using the datasets in most common LCA software: SimaPro, GaBi, OpenLCA and Quantis SUITE 2.0. A first series of datasets will be submitted to the ecoinvent Centre for their integration in the ecoinvent v3.3 database, in 2016. The entire database will be made public through the same channel by 2018.

## 4. Conclusion

The WFLDB is a comprehensive LCA food database providing detailed LCI data of high scientific quality, reliability and transparency, while being in line with other database developments such as ecoinvent v3.

The database provides a large number of new food-related inventory datasets with a focus on different regional specificities. By providing unit process that can easily be customized and combined, WFLDB gives high flexibility to final users in performing LCA.

Key learnings from the last 3 years of data development, as well as recommendations to practitioners and companies interested in the LCA of food products will be presented.

## 5. References

- [1] Pardo, G. and J. Zufia (2012). Life cycle assessment of food-preservation technologies. *Journal of Cleaner Production* 28: 198-207.
- [2] Ruviaro, C. F., M. Gianezini, F. S. Brandao, C. A. Winck and H. Dewes (2012). Life cycle assessment in Brazilian agriculture facing worldwide trends. *Journal of Cleaner Production* 28: 9-24.
- [3] Saarinen, M., S. Kurppa, Y. Virtanen, K. Usva, J. Makela and A. Nissinen (2012). Life cycle assessment approach to the impact of home-made, ready-to-eat and school lunches on climate and eutrophication. *Journal of Cleaner Production* 28: 177-186.
- [4] Notarnicola, B., K. Hayashi, M. A. Curran and D. Huisingh (2012). Progress in working towards a more sustainable agri-food industry. *Journal of Cleaner Production* 28: 1-8.
- [5] Weidema B P, Bauer C, Hirschier R, Mutel C, Nemecek T, Reinhard J, Vadenbo C O, Wernet G (2013). Overview and methodology. Data quality guideline for the ecoinvent database version 3. *Ecoinvent Report 1(v3)*. St. Gallen: The ecoinvent Centre
- [6] ISO (2006a) ISO 14040:2006 Environmental management - Life cycle assessment - Principles and framework. International Standards Organization.
- [7] ISO (2006b) ISO 14044:2006 Environmental management – life cycle assessment – requirements and guidelines. International Standards Organization.

- [8] International Reference Life Cycle Data System (ILCD) Handbook, General guide for Life Cycle Assessment, Detailed guidance. Publications Office of the European Union.
- [9] European Commission (2014). Environmental Footprint Pilot Guidance document. Guidance for the implementation of the EU Product Environmental Footprint (PEF) during the Environmental Footprint (EF) Pilot Phase, v. 4.0, May 2014.
- [10] FAO. (2014). LEAP - Greenhouse gas emissions and fossil energy demand from poultry supply chains. Guidelines for quantification. Rome, Italy.
- [11] FAO. (2014). LEAP - Environmental performance of large ruminant supply chains. Guidelines for assessment. Draft for public review. Rome, Italy.
- [12] FAO. (2014). LEAP - Environmental performance of animal feeds supply chains. Guidelines for quantification. Rome, Italy.
- [13] Nemecek T., Bengoa X., Lansche J., Mouron P., Rossi V. & Humbert S. (2014) Methodological Guidelines for the Life Cycle Inventory of Agricultural Products. Version 2.0, July 2014. World Food LCA Database (WFLDB). Quantis and Agroscope, Lausanne and Zurich, Switzerland.
- [14] Nemecek T., Bengoa X., Lansche J., Mouron P., Riedener E., Rossi V. & Humbert S. (2015) Methodological Guidelines for the Life Cycle Inventory of Agricultural Products. Version 3.0, July 2015. World Food LCA Database (WFLDB). Quantis and Agroscope, Lausanne and Zurich, Switzerland.
- [15] International Dairy Federation (IDF) (2015). A common carbon footprint approach for Dairy. The IDF guide to standard life cycle assessment methodology for the dairy sector. Brussels, Belgium.
- [16] Koch P., Salou T. (2015) AGRIBALYSE®: Rapport Méthodologique - Version 1.2. Mars 2015. Ed ADEME, Angers, France. 393 p.
- [17] Bosque, F., Réthoré, O., Bortoli, H., Bayart J.B., Gaillard, G. (2012). Acyvia: Creation of a public LCI/LCIA database of the French food industry, 8th International Conference on Life Cycle Assessment in the Agri-Food Sector. October 2-4, 2012, Saint-Malo, France.

# Creating coherent life cycle databases for ecodesign and product declaration of agro-industrial products: how to implement methodological choices

Patrik Mouron<sup>1</sup>, Jens Lansche<sup>1</sup>, Thomas Nemecek<sup>1</sup>, Gérard Gaillard<sup>1</sup>

<sup>1</sup>Agroscope, Institute for Sustainability Sciences, Reckenholzstrasse 191, CH-8046 Zürich, Switzerland  
E-mail contact: [patrik.mouron@agroscope.admin.ch](mailto:patrik.mouron@agroscope.admin.ch)

## 1. Abstract

*Existing guidelines and standards for creating LCI databases provide partly contradictory requirements, which lead to initiatives that aim on harmonization. As the harmonization is still ongoing, this challenges current database projects to find a scientifically sound and applicable way to establish coherent datasets. We present a four-step approach to deal with this challenge. Based on our experiences in the two ongoing projects ACYVIA and WFLDB we draw the following conclusions: it has been shown that by following the proposed approach, most con-contradictory advices from different guidelines do not appear because the number of relevant guidelines can be reduced. Creating a database that allows different methodological decisions can be achieved by clearly defining and reporting all methodological decisions that are followed. For remaining contradictory requirements, decision criteria are presented that can be taken into consideration to decide for one specific requirement.*

*Keywords: LCI database, agri-food sector, methodological guidelines, harmonization*

## 2. Introduction

Agricultural production systems and the processing of agricultural raw materials to food products contribute significantly to several environmental impacts like global warming, eutrophication and acidification [1, 2, 3]. Emissions from agricultural production systems show a high temporal and spatial variability which is a reason for a high variability of environmental impacts of these systems [4, 5, 6, 7]. These facts together with an increasing public interest enforce the demand for LCI data in the agri-food sector in companies, science and governments in the last years. Various guidelines exist (Table 1) with partly contradictory requirements which causes confusion [8]. A recent review of such reference methods conclude that flexibility with respect to methodological standards is more common than prescriptive requirements are [9]. In this context, several initiatives and projects deal with the creation of LCI databases that are either focused on the agri-food sector or cross-sectorial including agri-food related content, e.g. ACYVIA [10], AGRIBALYSE® [11], Asian Agri-Food database [12], Australian LCI Database initiative [13], Base IMPACTS® [14], Chilean Food and Agriculture LCA database [15], ecoinvent [16], ELCD [17], World Food LCA database [18].

This paper wants to start a discussion on the question how one can deal with the situation of existing guidelines and standards with contradictory requirements when creating an LCI database. The focus is on LCI modelling and the ideas presented are not final solutions but rather a starting point for further discussions. Basically, three steps are presented:

- 1) Categorizing the database to select the appropriate standard, guideline or tool for the purpose of the database to avoid contradictions
- 2) Showing an example for dealing with the requirement that a database should be applicable for different purposes
- 3) Developing basic principles on how to deal with remaining contradictions

*Table 1: Non exhaustive list of existing guidelines and standards for LCI database development.*

<b>Short Title</b>	<b>Full title of the guideline or standard</b>	<b>Reference</b>
BPX 30-323-0	Environmental communication on mass market products — Part 0: General principles and methodological framework	[19]
PAS 2050:2011	The Guide to PAS 2050:2011: How to carbon footprint your products, identify hotspots and reduce emissions in your supply chain	[20]
PEF Guide	Product Environmental Footprint (PEF) Guide, Annex II to the Recommendations of the Commission of 9 April 2013 on the use of common methods to measure and communicate the life cycle environmental performance of products and organizations	[21]
Envifood protocol	Environmental Assessment of Food and Drink Protocol	[22]
MTT Guidelines	Guidelines for the assessment of the life cycle greenhouse gas emissions of food	[23]
IDF Guide	A common carbon footprint approach for dairy – The IDF guide to standard lifecycle assessment methodology for the dairy sector	[24]
IPCC Guidelines	Guidelines fo National Greenhouse Gas Inventories -Agriculture, Forestry and other Land Use.	[25]
ISO 14025:2006	Environmental labels and declarations - Type III environmental declarations - Principles and procedures	[26]
ISO 14040:2006	Environmental management - Life cycle assessment - Principles and framework	[27]
ISO 14044:2006	Environmental management - Life cycle assessment – Requirements and guidelines	[28]
ISO 14067:2013	Carbon footprint of products—requirements and guidelines for quantification and communication.	[29]
ILCD Handbook	International Reference Life Cycle Data System (ILCD) Handbook - General guide for Life Cycle Assessment - Detailed guidance	[30]
Shonan Guidance Principles	Global Guidance Principles for Life Cycle Assessment Databases , A basis for greener processes and products	[31]
Ecoinvent data quality guidelines	Overview and methodology. Data quality guideline for the ecoinvent database version 3	[16]

### 3. Methods

The following methodological procedure is a proposition on how a coherent database could be created given the various guidelines and methodological recommendations as illustrated in Table 1 above. We suggest a procedure with the following main steps:

- Step 1: Categorizing the database as “general database” or “specific database”. For categorizing a database we propose to use specifications for the geography, application, and sector that are addressed given in Table 2.
- Step 2: Identify the most relevant guidelines (from Table1) related to the database.
- Step 3: Identify the methodological options that are crucial for the database. Options for LCI occur e.g. for system boundary choice, direct emission modeling, allocation methods, end-of-life modeling, data source choices and the kind of dataset documentation.

Step 4: Decide which options to use in order to meet the criteria according to Table 2

This four-step procedure is applied to two ongoing database projects that are:

- WFLDB (World Food LCA Database): This project is developing datasets for selected agricultural primary products as well as food and beverage products produced in the most relevant countries that supply the global market.
- ACYVIA (Analyse de Cycle de Vie dans les Industries Agro-alimentaires): This project addresses environmental product declaration of food transformation processes at national-level in France.

Table 2: Categorizing food LCI databases

Criteria	General database	Specific database
Geographical specification	Global, multi-national	National, regional
Application addressed	Ecodesign <u>and</u> Environmental product declaration (EPD)	Ecodesign <u>or</u> Environmental product declaration (EPD)
Sectorial specification	Agriculture <u>and</u> food industry	Agriculture <u>or</u> food industry

### 4. Results

#### 4.1 Categorizing databases

The two database projects WFLDB and ACYVIA can be clearly categorized with as “General database” and “Specific database”, respectively (Table 3). Table 2 shows also that the two projects differ very much in the order of guidelines that are most relevant for each project. For ACYVIA the BPX guidelines are of the highest importance defining methods for LCI modelling, system boundaries, allocation and end-of-life modelling, whereas the ILCD entry-level is of importance regarding the method for data quality assessment and the selection of external reviewers. As a consequence, in case of the ACYVIA database practically no choices regarding methodological options remain, since BPX defines them all for EPD in France. In contrast, for WFLDB due to the wide range of geographical, sectorial applications a number of methodological decisions according to ISO 14044/44 have to be made. In practice this means that for each methodological issue one option has to be chosen. Such choices need to be described in the documentation of the database.



But whatever option is chosen, it might be that for a certain database user and for certain applications this methodological option is not the one that suits well. Therefore we model a methodological option in a reversible way, i.e. the user will have the opportunity to apply another methodological option that fits to the desired application. This is e.g. the case when economic allocation is applied but mass allocation would be preferred by a user. In the following we will illustrate for the case of modelling “heavy metal uptake by crops” what is meant by giving the option to the user to exclude heavy metal uptake.

*Table 3: Categorizing WFLDB and ACYVIA database and associated relevant guidelines*

	<b>WFLDB</b>	<b>ACYVIA</b>
	<b>General database</b>	<b>Specific database</b>
<b>Geographical specification</b>	Global	National
<b>Application addressed</b>	Ecodesign and EPD	EPD
<b>Sectorial specification</b>	Agriculture and food industry	Food industry
<b>Guidelines</b>	1. ISO 14040/ 44	1. BPX 30-323-0
<b>(order of importance)</b>	2. ILCD handbook	2. ILCD entry-level
	3. ENVIFOOD	3. ISO 14040/ 44
	4. Others	4. Others

#### *4.2 Option of including or excluding “heavy metal uptake by crops”*

In crop production heavy metals (e.g. Cadmium) will be imported to the field by inputs such as mineral fertilizers. On the field the plant takes up nutrients but also heavy metals that will be exported from the field with the harvested crop. In case the whole life cycle (i.e. from cradle to grave) is assessed, the amount of heavy metal exported by the crop is of interest since this might cause toxicological problems at another place (e.g. waste water treatment after consumption and digestion). But if the LCA addresses only the crop production on the field (i.e. cradle to gate) the uptake of heavy metal could lead to unrealistic “credits” and therefore should be excluded from the assessment. We suggest to model heavy metal uptake in such a way that the uptake by the plant can be set to zero, if needed.

### **5. Discussion**

We proposed a first approach how one can deal with the situation of guidelines and standards with contradictory requirements when creating an LCI database. The three criteria (geography, application, economic sector) for categorizing databases have been sufficient for the two projects WFLDB and ACYVIA but its sufficiency and applicability need to be proved in practice with other databases.

If contradictions remain, we propose to develop a hierarchy of basic principles that support to make appropriate methodological decisions in respect to LCI modelling. Such criteria can be:

- **scientific nature of the requirement**
- **internal consistency of the database**
- **acceptance by stakeholders**

The ideas presented have to be further developed and tested more comprehensively in practice.

## 6. Conclusion

By categorizing databases, relevant guidelines can be selected. This helps to identify the relevant methodological options. By following this approach, most contradictory advices from different guidelines do not appear because the number of relevant guidelines can be reduced for each individual database.

## 7. References

- [1] Pardo, G. and J. Zufia (2012). "Life cycle assessment of food-preservation technologies." *Journal of Cleaner Production* 28: 198-207.
- [2] Ruviaro, C. F., M. Gianezini, F. S. Brandao, C. A. Winck and H. Dewes (2012). "Life cycle assessment in Brazilian agriculture facing worldwide trends." *Journal of Cleaner Production* 28: 9-24.
- [3] Saarinen, M., S. Kurppa, Y. Virtanen, K. Usva, J. Makela and A. Nissinen (2012). "Life cycle assessment approach to the impact of home-made, ready-to-eat and school lunches on climate and eutrophication." *Journal of Cleaner Production* 28: 177-186.
- [4] Mouron, P., T. Nemecek, R. W. Scholz and O. Weber (2006). "Management influence on environmental impacts in an apple production system on Swiss fruit farms: Combining life cycle assessment with statistical risk assessment." *Agriculture, Ecosystems & Environment* 114(2-4): 311-322.
- [5] Roy, P., D. Nei, T. Orikasa, Q. Xu, H. Okadome, N. Nakamura and T. Shiina (2009). "A review of life cycle assessment (LCA) on some food products." *Journal of Food Engineering* 90(1): 1-10.
- [6] Nemecek, T., K. Weiler, K. Plassmann, J. Schnetzer, G. Gaillard, D. Jefferies, T. Garcia-Suarez, H. King and L. Mila i Canals (2012). "Estimation of the variability in global warming potential of worldwide crop production using a modular extrapolation approach." *Journal of Cleaner Production* 31: 106-117.
- [7] Rees, R. M., J. Augustin, G. Alberti, B. C. Ball, P. Boeckx, A. Cantarel, S. Castaldi, N. Chirinda, B. Chojnicki, M. Giebels, H. Gordon, B. Grosz, L. Horvath, R. Juszczak, Å. Kasimir Klemedtsson, L. Klemedtsson, S. Medinets, A. Machon, F. Mapanda, J. Nyamangara, J. E. Olesen, D. S. Reay, L. Sanchez, A. Sanz Cobena, K. A. Smith, A. Sowerby, M. Sommer, J. F. Soussana, M. Stenberg, C. F. E. Topp, O. van Cleemput, A. Vallejo, C. A. Watson and M. Wuta (2013). "Nitrous oxide emissions from European agriculture &ndash; an analysis of variability and drivers of emissions from field experiments." *Biogeosciences* 10(4): 2671-2682.
- [8] Finkbeiner, M. (2014). "Product environmental footprint—breakthrough or breakdown for policy implementation of life cycle assessment?" *The International Journal of Life Cycle Assessment* 19(2): 266-271.
- [9] Pelletier, N., K. Allacker, R. Pant and S. Manfredi (2014). "The European Commission Organisation Environmental Footprint method: comparison with other methods, and rationales for key requirements." *The International Journal of Life Cycle Assessment* 19(2): 387-404.
- [10] Bosque, F., O. Réthoré, S. Kerner, H. Bortoli, L. Peano, S. Humbert, G. Gaillard and J. Lansche (2012).
- [11] ACYVIA: creation of a public LCI/LCIA database of the French food industry. 8th International Conference on Life Cycle Assessment in the Agri-Food Sector, Saint-Malo, France, INRA.
- [12] Koch, P. and T. Salou (2013). *AGRIBALYSE®: Rapport Méthodologique – Version 1.0*. E. ADEME. Angers, France, ADEME.
- [13] Hayashi, K. (2013). *LCA Agri-food Asia Initiative*. P. Mouron. Zurich, Switzerland, Hayashi, Kiyotada.
- [14] ALCAS (2014). "AusLCI The Australian National Life Cycle Inventory Database ". Retrieved 30.04.2014, 2014, from <http://alcas.asn.au/AusLCI/index.php/Home>.
- [15] ADEME (2014). "Base IMPACTS ® - Base d'indicateurs d'impacts ACV pour l'affichage environmental des produits de grande consommation." Retrieved 30.04.2014, 2014, from <http://www.base-impacts.ademe.fr/>.
- [16] Emhart, C., A. Florenzano, C. Loyola and J. Bengtsson (2013). *Chilean Food and Agriculture LCA Database using UNEP/SETAC Shonan Guidance Principles*. The 6th International Conference on Life Cycle Management (LCM 2013), Gothenburg.
- [17] Weidema, B., C. Bauer, R. Hischer, C. Mutel, T. Nemecek, J. Reinhard, C. Vadenbo and G. Wernet (2013). *Overview and methodology. Data quality guideline for the ecoinvent database version 3*. St. Gallen, Swiss Centre for Life Cycle Inventories.

- [18] RC (2014). "ELCD - European reference Life Cycle Database." Retrieved 30.04. 2014, 2014, from <http://eplca.jrc.ec.europa.eu/ELCD3/index.xhtml>.
- [19] Lansche, J., G. Gaillard, T. Nemecek, P. Mouron, L. Peano, X. Bengoa, S. Humbert and Y. Loerincik (2013). The World Food LCA Database project: towards more accurate food datasets. The 6th International Conference on Life Cycle Management (LCM 2013), Gothenburg.
- [20] Afnor (2011). Environmental communication on mass market products — Part 0: General principles and method-ological framework (BPX 30-323-0). La Plaine Saint-Denis Cedex, France, Association Française de Normalisation. BPX 30-323-0.
- [21] BSI (2011). The Guide to PAS 2050:2011: How to carbon footprint your products, identify hotspots and reduce emissions in your supply chain. London, British Standards Institution.
- [22] EC (2013). Product Environmental Footprint (PEF) Guide, Annex II to the Recommendations of the Commission of 9 April 2013 on the use of common methods to measure and communicate the life cycle environmental performance of products and organizations, COM (2013) 179. Luxembourg, Official Journal of the European Union, Legislation (L 124), Volume 56, Publications Office of the European Union.
- [23] Envifood (2013). Environmental Assessment of Food and Drink Protocol, Version 1.0. E. F. S. C. P. R. Table.
- [24] Hartikainen, H. K., Juha-Matti; Pulkkinen, Hannele; Saarinen, Merja; Silvenius, Frans; Usva, Kirsi (2012). Guidelines for the assessment of the life cycle greenhouse gas emissions of food. Helsinki, Finland, MTT Agrifood Research Finland, Responsible food chain – better consumer wellbeing.
- [25] IDF (2010). A common carbon footprint approach for dairy – The IDF guide to standard lifecycle assessment methodology for the dairy sector. Brussels, International Dairy Federation (I.N.P.A).
- [26] IPCC (2006). Guidelines for National Greenhouse Gas Inventories -Agriculture, Forestry and other Land Use. IGES, Japan, Institute for Global Environmental Strategies (IGES), Hayama, Japan on behalf of the IPCC.
- [27] ISO (2006a). Environmental labels and declarations - Type III environmental declarations - Principles and procedures. Geneva, Switzerland. ISO 14025:2006.
- [28] ISO (2006b). Environmental management - Life cycle assessment - Principles and framework. Geneva, Switzerland, International Organization for Standardization. ISO 14040:2006.
- [29] ISO (2006c). Environmental management - Life cycle assessment – Requirements and guidelines. Geneva, Switzerland, International Organization for Standardization (ISO). ISO 14044:2006.
- [30] ISO (2013). Carbon footprint of products—requirements and guidelines for quantification and communication. Geneva, Switzerland, International Organization for Standardization (ISO). ISO 14067:2013.
- [31] JRC (2010). International Reference Life Cycle Data System (ILCD) Handbook - General guide for Life Cycle Assessment - Detailed guidance. Luxembourg.
- UNEP/SETAC (2011). Global Guidance Principles for Life Cycle Assessment Databases, A basis for greener processes and products, 'Shonan Guidance Principles'. Paris, France, UNEP/SETAC Life Cycle Initiative.

## Wheat of today and tomorrow: an assessment of current LCI inventories

Sara Corrado<sup>1,2</sup>, Valentina Castellani<sup>2</sup>, Luca Zampori<sup>2</sup>, Serenella Sala<sup>2</sup>

<sup>1</sup> Università Cattolica del Sacro Cuore, Istituto di chimica agraria e ambientale,  
Via Emilia Parmense 84, 29122 Piacenza (PC), Italy

<sup>2</sup> European Commission, Joint Research Centre (JRC), Institute for Environment and Sustainability (IES),  
via Enrico Fermi 2749, 21027 Ispra (Va), Italy

E-mail contact: sara.corrado@unicatt.it

### 1. Abstract

Secondary data can play an important influence on the LCA results when assessing the environmental performance of a product. This work aimed at analysing datasets currently available in some commonly used LCA databases (DBs) (Ecoinvent v3, Agrifootprint and Agribalyse) in order to define how different modelling approaches can condition the environmental performance of an agro-food product. Furthermore, some considerations on the sources of data and the modelling choices performed within databases were derived.

Wheat primary production in France was chosen as representative process for the study.

The analysis highlighted significant differences among the environmental performance of the same product in different DBs related to both the choice of data and the modelling approach.

### 2. Introduction

Performing a LCA of a product is a resources-intensive process and data collection can be identified as a critical point. The use of secondary data is consequently a common practice in order to streamline the assessment of the environmental performance of a product [1]. DBs are a major source of secondary data and the choice of the DB for background data can substantially influence the results of the study. Indeed the environmental performance of equivalent products (same production process and geographical location) can significantly vary due to differences in both the sources of the inventory data and the modelling approach adopted in different DBs.

This work aims at analysing datasets currently available in some LCA DBs commonly used in the agro-food sector (Ecoinvent v3, Agribalyse and Agrifootprint).

Wheat was selected as representative cereal, since it is contained in a large share of food products, for which the increase of both quality and robustness of agricultural inventories is of utmost importance. Wheat production in France was chosen as a representative process, since France is one of the main European wheat producers.

Starting from the analysis of the LCA results, comparisons among the sources of data and the modelling approaches were done in order to identify points of convergence and divergence among datasets and to derive some considerations on the appropriateness of the choices. Moreover, the consistency of the inventory data with FAO statistics, European regulations and other agricultural statistics and the compatibility between the inventory flows and the characterisation methods recommended by the International Reference Life Cycle Data System [2] and the Product Environmental Footprint (PEF) [3] were investigated.

The results of the analysis can be used by LCA practitioners to choose the most appropriate DB according to the specific aim of their studies.

### 2.1 Wheat inventories analysis

Three datasets were considered (Table 1). The effect of allocation of the impacts to straw was removed, allocating the entire environmental burden of the field activities to the wheat grains.

Table 1: Datasets considered in the analysis

Database	Process denomination
Agribalyse	Soft wheat grain, conventional, national average, at farm gate/FR U
Agrifootprint	Wheat grain, at farm/FR
Ecoinvent v3	Wheat grain {FR}   wheat production   Alloc Def, U

The analysis was performed with the software Simapro v. 8.0.4.30, using the ILCD Midpoint impact assessment method as implemented in the software with updated characterisation factors for land use (ILCD v.1.0.6) [4].

The analysis was focused on the foreground system of wheat cultivation. Only the elementary flows with the largest contributions (cut-off 1%) to each impact category were subject to the analysis. Significant differences were observed in the LCA results of the datasets considered. In the next paragraphs the analysis of human toxicity and land use impact categories is reported.

### 2.2 Human toxicity

Figure 1: Impact on human toxicity impact categories ( $CTUh/kg_{wheat}$ )

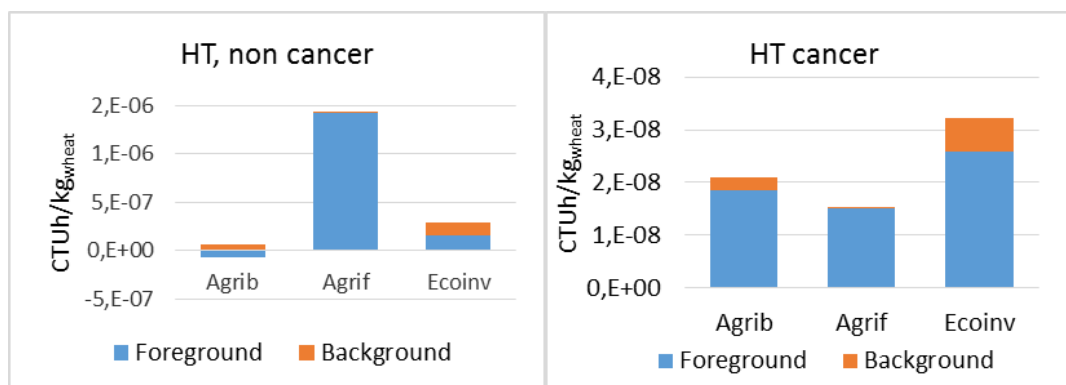

Impact on human toxicity includes both carcinogenic and non-carcinogenic effects (Figure 1). For both, the main foreground contributions are from heavy metals emissions in soil and water.

The heavy metals balance is modelled with the same approach in the three DBs [5]: emissions of heavy metals into the soil are obtained from the balance of inputs and outputs. However the type and the amount of inputs and the outputs considered in different DBs vary significantly (Table 2).

Table 2: Inputs and outputs considered for the heavy metals modelling

		Agribalyse	Agrifootprint	Ecoinvent v3
<b>Inputs</b>	Seeds	Yes	No	Yes
	Pesticide	Yes	No	Yes
	Fertilisers	Yes	Yes	Yes
	Manure	Yes	Yes	Not applied
	Deposition	Yes	Yes	Yes
<b>Outputs</b>	Leaching	Yes	Yes	Yes
	Runoff	Yes	No	Yes
	Biomass removal	Yes	Yes	Yes

It has to be considered that heavy metals leaching and runoff due to soil erosion are taken into account in the Agribalyse and Ecoinvent v3 datasets, but no specific characterisation factors are reported in order to take into account the different heavy metals fates (respectively groundwater and surface water) related with these two removal mechanisms.

### 2.3 Land use

The impact on land use is associated with both land occupation and land transformation. The main contribution is from the foreground system (Figure 2) mainly due to land occupation, except for Agribalyse in which transformation processes play an important role.

Figure 2: Impact on land use (kgCdeficit/kg<sub>wheat</sub>)

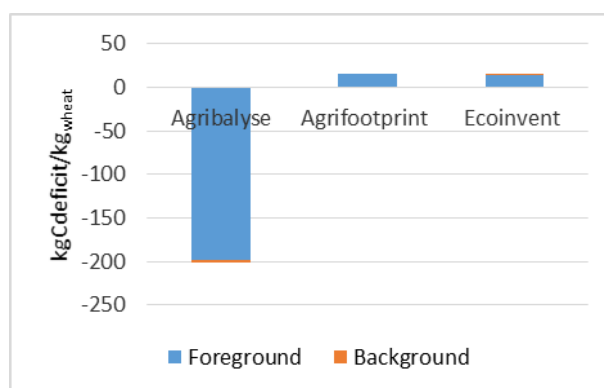

In Agribalyse and Ecoinvent v3 the same modelling approach is adopted but they refer to different data sources (Table 3) Agribalyse dataset refers to national average land use change data reporting a negative impact associated to the flow “transformation from urban, discontinuously built”. It represents the 2,26% of the transformed area but the flow has a highly negative characterisation factor, resulting in a negative contribution on the potential impact on land use. In Ecoinvent v3 datasets, instead, the net transformation contributions resulted null due to the fact the wheat cultivation was part of a crop rotation and did not cause a specific land transformation. Agrifootprint reports a net positive transformation from permanent crop cultivation to arable land (Table 4).

Table 3: Models and sources of primary data for land transformation

	Land transformation	
	Model	Sources of data
<b>Agribalyse</b>	Frischknecht et al, 2007 [6]	Teruti-Lucas, 2006 [7]
<b>Agrifootprint</b>	Direct land use change assessment tool	FAOstat
<b>Ecoinvent v3</b>	Frischknecht et al, 2007 [6]	Field data

Table 4: Inventory data for land transformation (flows belonging to the same category and with the same characterisation factor have been summed)

	Agribalyse	Agrifootprint	Ecoinvent v3
<b>Transformation to arable</b>	10000,0	47,3	1,5
<b>Transformation from arable</b>	9629,2	41,7	1,5
<b>Transformation from permanent crop</b>	9,6	5,6	0
<b>Transformation from forest</b>	67,9	0	0
<b>Transformation from pasture and meadow</b>	67,1	0	0
<b>Transformation from urban, discontinuously built</b>	226,1	0	0

#### 4. Conclusion

The analyses of wheat inventories highlighted that the differences among the data sources and modelling approaches in the three DBs affected significantly the results. LCA practitioners are recommended to consider this aspect and to perform an accurate choice of secondary datasets in compliance with the goal and scope of the study.

#### 5. References

- [1] Teixeira R.F.M., 'Critical Appraisal of Life Cycle Impact Assessment Databases for Agri-food Materials', *Journal of Industrial Ecology* 19 (1) (2015) 38-50.
- [2] European Commission - Joint Research Centre - Institute for Environment and Sustainability, *International Reference Life Cycle Data System (ILCD) Handbook - General guide for Life Cycle Assessment - Detailed guidance*. First edition March 2010. EUR 24708 EN. Luxembourg. Publications Office of the European Union, 2010
- [3] European Commission, Communication (2013) 196, 'Building the Single Market for Green Products - Facilitating better information on the environmental performance of products and organisations', 2013.
- [4] Joint Research Centre, European Platform on LCA. [http://eplca.jrc.ec.europa.eu/?page\\_id=1159](http://eplca.jrc.ec.europa.eu/?page_id=1159)
- [5] Freiermuth R., *Modell zur Berechnung der Schwermetallflüsse in der Landwirtschaftlichen Ökobilanz - SALCA-Schwermetall*, Forschungsanstalt Agroscope Reckenholz-Tänikon (ART), 2006
- [6] Frischknecht R., Jungblut N., Althaus H-J., Doka G., Dones R., Heck T., Hellweg S., Hirschier R., Nemecek T., Rebitzer G., Spielmann M. and Wernet G., 'Overview and methodology - Data v2.0 (2007). ecoinvent® report No. 1.' Ed Swiss Center for Life Cycle Inventories, Dübendorf, Switzerland, 2007
- [7] Teruti-Lucas, 'L'utilisation du territoire en 2009'.
- [8] <http://www.agreste.agriculture.gouv.fr/publications/chiffres-et-donnees/article/l-utilisation-du-territoire-en-601>

# Food PEFCRs and the need for consistent secondary databases such as Agri-footprint®

Author(s): Bart Durlinger<sup>1</sup>, Hans Blonk<sup>1</sup>, Jasper Scholten<sup>1</sup>

<sup>1</sup> Blonk Consultants, Gravin Beatrixstraat 34, Gouda

E-mail contact: bart@blonkconsultants.nl

## 1. Abstract

*This paper describes the food PEFCR developments so far and the technical consequences for Agri-footprint®. This is illustrated by an LCA case study on animal production, which shows the differences between the PEF compliant Cattle Model Working Group recommendations and the former allocation and emission modelling in Agri-footprint®. The future development of Agri-footprint® is to follow this same route of supporting other major sector guidelines or PCR developments, such as the development of datasets that support studies compliant to the LEAP guidelines of FAO.*

## 2. Introduction

In April 2013 the European Commission published the Product Environmental Footprint (PEF) method. This method is a framework of general requirements and principles for LCA. The European Commission aims to develop more specific technical guidance for product groups ('category rules') and tests the development of PEFCR with several European industrial sectors.

In 2014, the second wave of 11 PEF food pilots started, which involves food product groups such as red meat, dairy, beer, wine, pasta. Blonk Consultants supports the development of three pilots (feed, beer and red meat). Since it is the goal of PEFCRs is to support the communication of the environmental performance of products, data consistency and compliance with PEFCR requirements is key.

Agri-footprint® is an LCA database that is developed with the intent to support the development of agricultural and food product (agri-food) LCAs, for a wide range of applications. This is the reason that it supports multiple allocation and emission modelling methods. The PEF pilot initiatives generate new data requirements on for example allocation. These will be implemented in future updates of Agri-footprint® to support PEF-compliant calculations. A first step of alignment of Agri-footprint® to the PEF data quality requirements is integration of the calculation approach of the Cattle Model Working Group (CMWG) in Agri-footprint® 2.0, which is scheduled to be released in Q3/Q4 of 2015. The CMWG provided specific guidance on how to allocate between co-products on the farm and slaughterhouse level, and on how to calculate specific emissions from animal husbandry (such as ammonia and nitrous oxide emissions). To show some of the implications of the implementation of CMWG calculation rules, a case study on Dutch dairy and Irish beef will be presented in this paper, where the original life cycle inventories of Agri-footprint are compared to the inventories aligned to the CMWG calculation rules.



### 3. Methodology

#### 3.1 Calculation framework of Cattle model working group

The objective of the cattle model working group was to harmonize LCA PEF methodology at farm and slaughterhouse level by reaching a consensual agreement regarding:

- **Allocation of upstream burdens among the outputs at farm and among outputs at slaughterhouse level,**
- **Models for methane emission from enteric fermentation,**
- **Models for emissions from manure management and**
- **A model for carbon sequestration/release in grassland systems.**

The results of the CMWG and the methodologies are to be used as baseline approach in feed, dairy, meat, leather and pet food pilots throughout the pilot process and are described in a report [1]. Agri-footprint 2.0 contains life cycle inventories which take into account the CMWG baseline approaches (PEF compliant processes) for, Dairy farm systems in the Netherlands, Irish beef, and associated slaughterhouse processes. The main differences between the default Agri-footprint and the CMWG baseline approaches are (1) the allocation between co-products and (2) the calculation of certain types of emissions (see table 1)

When the Agri-footprint approach complies with the CMWG baseline approach or uses a higher Tier level, the Agri-footprint approach has been used in the PEF compliant processes.

*Table 1 : Main differences between Agri-footprint approach and CMWG baseline approach (CMWG = Cattle model working group, CH<sub>4</sub> = Methane, EMEP/EEA = European Monitoring and Evaluation Programme / European Environment Agency, FAO = Food and Agriculture Organisation of the United Nations, IDF = International Dairy Federation, IPCC = Intergovernmental Panel on Climate Change, N<sub>2</sub>O = Nitrous Oxide, NH<sub>3</sub> = Ammonia, NMVOC = Non-methane volatile organic compounds)*

Topic	Agri-footprint	CMWG baseline approach
Allocation on the dairy farm	Economic/ Mass/ Gross energy content	IDF allocation
Allocation in the slaughterhouse	Economic/ Mass/ Gross energy content	Economic allocation with predefined allocation fractions
CH <sub>4</sub> emissions due to enteric fermentation	IPCC guidelines Tier 3	IPCC guidelines minimum Tier 2
CH <sub>4</sub> emissions due to manure management	IPCC guidelines Tier 2	IPCC guidelines minimum Tier 2
Direct and Indirect N <sub>2</sub> O emissions from livestock manure	IPCC guidelines Tier 2	IPCC guidelines minimum Tier 1
NH <sub>3</sub> emissions from livestock manure	IPCC guidelines Tier 2	EMEP/EEA guidelines minimum Tier 2
NO emissions from livestock manure	-	EMEP/EEA guidelines minimum Tier 2
NMVOC emissions from livestock manure	-	EMEP/EEA guidelines minimum Tier 2
Particulate matter emissions from livestock manure	EMEP/EEA guidelines minimum Tier 3	EMEP/EEA guidelines minimum Tier 2
Soil C stocks in grassland	Based on FAO statistics and IPCC calculation rules, following the PAS 2050-1 methodology	Not taken into account unless land use change happened less than 20 years before assessment year.

### 3.2 Systems to be compared

Currently, two bovine farming systems are included in Agri-footprint: a Dutch dairy system (producing raw milk, calves and cows for slaughter), and an Irish suckler-beef system (which only produces beef for slaughter). Also the associated slaughterhouse processes are included in Agri-footprint. Of these two bovine systems, two variants are modelled; the ‘default’ Agri-footprint inventories and modified ‘PEF-compliant’ inventories that comply to the rules of the CMWG document. To assess the effect of the CMWG allocation approach and emissions modelling, the ‘PEF-compliant’ Irish beef and Dutch dairy models are compared to the ‘default’ Agri-footprint inventories. A description of the underlying data and sources can be found in the methodology and data reports [2][3] accessible through [www.agri-footprint.com](http://www.agri-footprint.com). The unit of analysis was “1 kg of beef meat, fresh at slaughterhouse”. The Irish beef LCI was based on a study by Casey and Holden [4], whereas the Dutch dairy system was based on previous work by Blonk Consultants [5].

## 4. Results

Figure 1 presents the characterized results for Irish beef while Figure 2 presents the results for meat from Dutch dairy. As can be seen in Figure 1 the PEF compliant model is similar to the default Economic allocation approach of Agri-footprint. This makes sense as the CMWG recommends economic allocation at the slaughterhouse (and no allocation takes place on the farm). The only differences can be explained by different modelling approaches for calculating emissions from enteric fermentation and manure management.

Figure 1 :Impacts from beef meat, fresh, at slaughterhouse from Irish beef cattle. Results for the allocation as agreed in CMWG, and the three default Agri-footprint allocation options respectively

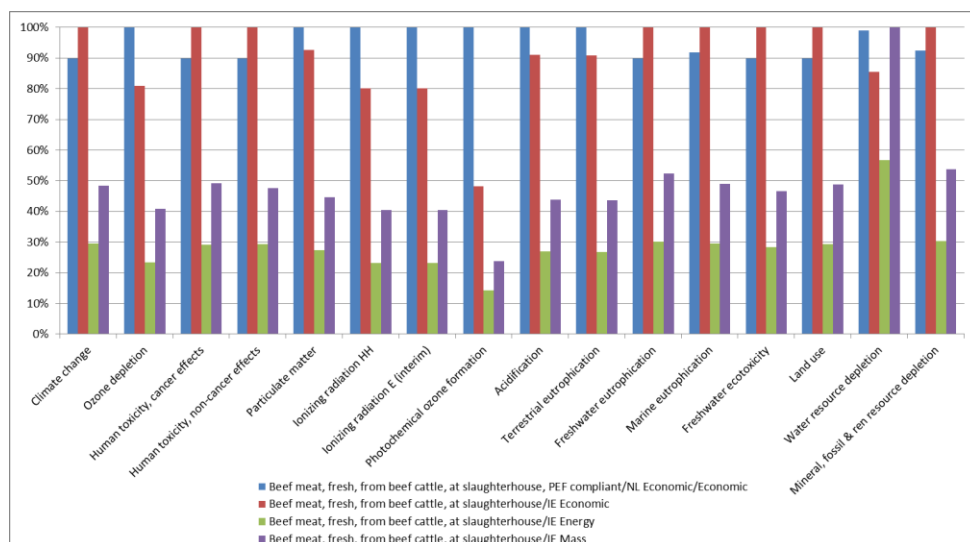

However the results for beef meat from Dutch dairy cows, shown in Figure 2 are substantially higher than the default Agri-footprint model. This is mainly explained by a shift in allocation on the dairy farm. Whereas Agri-footprint uses economic, mass or energy allocation, the PEF compliant model applies IDF allocation. In the PEF compliant study 12.35% of farm impacts are allocated to the cows for slaughter, whereas in the default Agri-footprint model (with economic allocation) 5.2% is attributed to the cows (and even lower in the other two allocations). This explains the big discrepancy between the results.

Figure 2: Impacts from dairy cow meat, fresh, at slaughterhouse from Dutch dairy cattle. Results for the allocation as agreed in CMWG, and the three default Agri-footprint allocation options (Economic/Energy/Mass), respectively

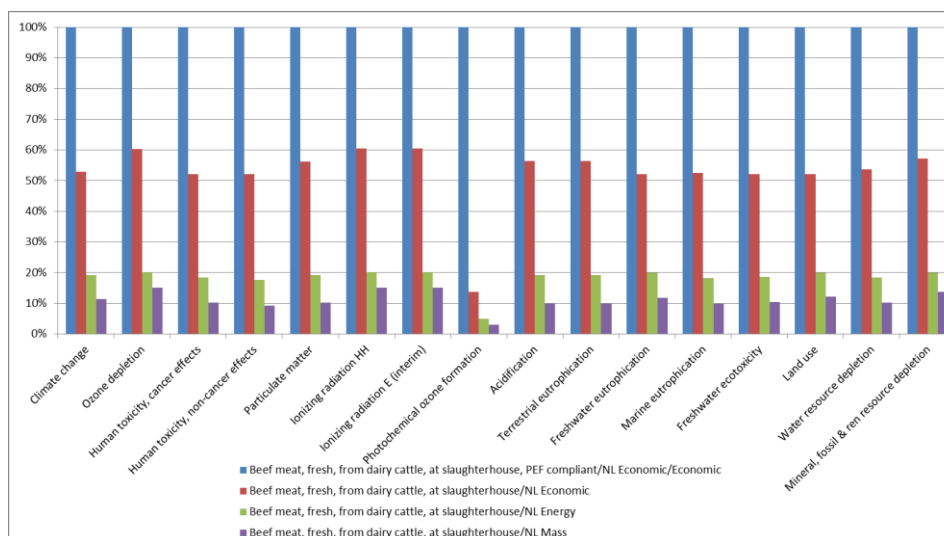

## 5. Conclusion

For Irish beef, the PEF compliant model provides similar results as the default Economic allocation approach of Agri-footprint. The only differences can be explained by different modelling approaches for calculating emissions from enteric fermentation and manure management. However the results for beef meat from Dutch dairy cows, are substantially higher than the default Agri-footprint model, which can be explained by the differences in allocation.

Whereas the more detailed emissions modelling calculations proposed by the CMWG can be seen as a refinement of the method, the decision to use IDF allocation on the dairy farm level has a major influence on the outcomes of future PEF studies of meat from dairy systems. This emphasizes that in order to make a fair (environmental footprint) comparison between products, clear calculation guidelines for cross-cutting issues between the PEF pilots need to be established, which should also be reflected in any secondary databases that are used.

## 5. References

- [1] JRC, “Baseline Approaches for the Cross-Cutting Issues of the Cattle Related Product Environmental Footprint Pilots in the Context of the Pilot Phase,” 2015.
- [2] Blonk Agri-footprint BV, “Agri-footprint 2.0 - Part 1 - Methodology and basic principles,” Gouda, the Netherlands, 2015.
- [3] Blonk Agri-footprint BV, “Agri-footprint 2.0 - Part 2 - Description of data,” Gouda, the Netherlands, 2015.
- [4] J. W. Casey and N. M. Holden, “Quantification of GHG emissions from suckler-beef production in Ireland,” *Agric. Syst.*, vol. 90, no. 1–3, pp. 79–98, Oct. 2006.
- [5] R. Broekema and G. Kramer, “LCA of Dutch semi-skimmed milk and semi-mature cheese,” 2014.

# LCA and footprints to assess food product chains





# Energy Use in the EU Food Sector: State of Play and Opportunities for Improvement

Fabio Monforti-Ferrario<sup>1</sup>, Jean-Francois Dallemand<sup>1</sup>, Hrvoje Medarac<sup>1</sup>, V Motola<sup>1+</sup>, Irene Pinedo<sup>1</sup>, Luca Castellazzi<sup>1</sup>, Paolo Bertoldi<sup>1</sup>, Nicola Labanca<sup>1</sup>, Manjola Banja<sup>1</sup>, Nicolae Scarlat<sup>1</sup>

Erwin M. Schau<sup>2</sup>, Malgorzata Goralczyk<sup>2</sup>, Serenella Sala<sup>2</sup>, Erwan Saouter<sup>2</sup>, David Pennington<sup>2</sup>

Bruno Notarnicola<sup>3</sup>, Giuseppe Tassielli<sup>3</sup>, Pietro Renzulli<sup>3</sup>

<sup>1</sup>European Commission, Joint Research Centre, Renewable Energy Unit, Via E. Fermi 2749, 21027 Ispra, Italy

<sup>2</sup>European Commission, Joint Research Centre, Sustainability Assessment Unit,  
Via Enrico Fermi 2749, 21027 Ispra, Italy

<sup>3</sup>Ionian Department of Law, Economics and Environment, University of Bari Aldo Moro, Bari, Italy  
E-mail contact: [fabio.monforti-ferrario@ec.europa.eu](mailto:fabio.monforti-ferrario@ec.europa.eu)

## 1. Abstract

*In the frame of its activities in supporting the EXPO 2015 and on the behalf of DG ENER, JRC has recently published a report [1] aimed at discussing the current state of play for food-related energy consumption and opportunities for improvement in the European Union. Detailed estimates for energy consumed in each production step for a basket of most representative food products were computed based on a LCA approach. These estimates have served as bases for discussing challenges and opportunities for making the EU food consumption "energy-smarter", both in terms of decreasing the overall energy consumed and increasing the share of renewable energy employed in the whole food chain*

## 2. Introduction

The food sector is a major consumer of energy and the amount of energy necessary to cultivate, process, pack and deliver the food to European citizens' accounts for a relevant share of overall energy consumption. This study presents the methodology and the main findings of a recent study aimed at identifying the current European situation for food-related energy consumption and opportunities for its improvement, where improvement could be pursued either through decreasing energy consumption and increasing the Renewable Energy (RE hereafter) share.

## 3. Methodology and data

### *Basket definition*

European food consumption is complex and the definition of a 'reference' EU food basket is a challenging task. Indeed, the basket cannot be too detailed so the analysis can be performed within a reasonable amount of time and resources, and should contain products for which robust data accepted and validated through peer reviewing is available.

JRC has recently developed a battery of 'basket of products' indicators [2], aimed at analysing and monitoring the consumption patterns in the EU and their related environmental impacts. The JRC basket-of-product study has been recently revised and updated, providing a picture of the nutrition basket updated to 2013 (see Table 1).

Table 1: JRC food basket – 2013 update

Basket product	Total consumption of basket product [1 000t/year]	Per-capita apparent consumption [kg/inhabitant year]	% of total per-capita apparent basket consumption	Economic value of the consumption of each basket product [million EUR/year]
Pig meat	22 449	44.7	8.1%	40 797
Beef	6 914	13.8	2.5%	30 818
Poultry	13 248	26.4	4.8%	28 444
Bread	19 136	38.1	6.9%	29 114
Milk and cream	39 326	78.2	14.2%	24 953
Cheese	9 347	18.6	3.4%	36 564
Butter	1 927	3.8	0.7%	7 193
Sugar	15 913	31.7	5.7%	11 383
Refined sunflower oil	2 661	5.3	1.0%	2 781
Olive oil	1 955	3.9	0.7%	4 490
Potatoes	36 475	72.6	13.1%	10 166
Oranges	7 012	14.0	2.5%	4 097
Apples	9 104	18.1	3.3%	5 340
Mineral water*	55 405 *	110.2 *	19.9%	11 358
Roasted coffee	1 793	3.6	0.6%	10 690
Beer *	33 553 *	66.8 *	12.1%	26 270
Prepared dishes and meals-meat based	1 502	3.0	0.5%	13 958
TOTAL	277 722	552.6	100.0%	298 415

\* in litres

This food basket does not cover all food consumption but represents the very noticeable mass share of 61% of the consumed food in 2013 in the EU-27. A detailed analysis of the overall environmental impacts of the JRC food basket has been developed through the LCA of each product, following a harmonised methodological framework. A detailed description of the methodology and data sources applied is available in [3]. The impact categories chosen are Cumulative Energy Demand v 1.08 and Global Warming. The cumulative energy demand is based on the method published by ecoinvent version 2.0 [4] and adopted to be used in the LCA software and databases. For Global warming, the characterisation factors are taken from the model developed by the Intergovernmental Panel on Climate Change (IPCC).

#### 4. Key results

Figure 1 – left panel shows the amount of energy embedded in the JRC food basket in units of MJ per EU citizen, broken down for the 17 products represented and their production steps. Figure 1 – right panel - shows the same data per kilogram (or litre) of product.

Figure 1: Energy embedded in the JRC food consumption basket for the average citizen, broken down for products and production steps. Units: left panel: MJ/capita – right panel: MJ/kg or MJ/l

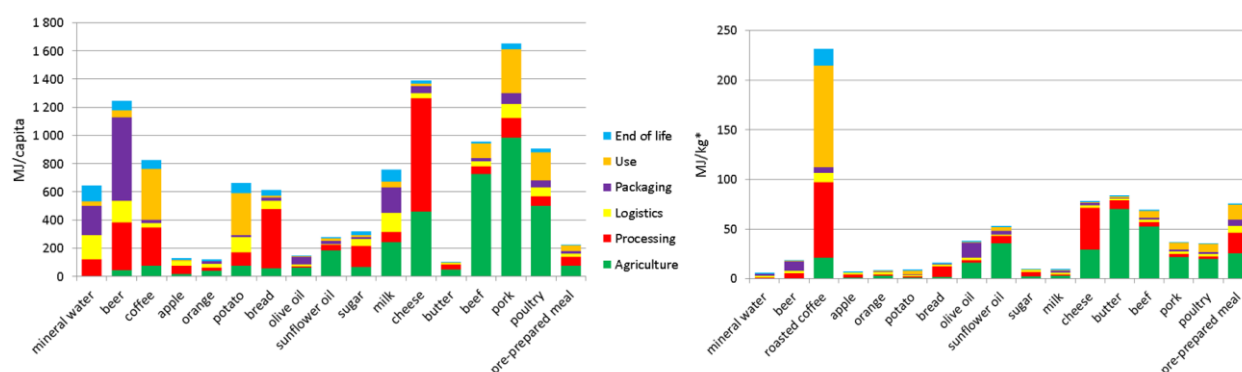

As JRC food basket does not cover the whole food consumption, results need to be upscaled to estimate the energy flows across the whole EU food supply chain. Products selected for the basket were expected to represent well the product groups to which they belong. Under this assumption, the energy embodied per mass unit in the 17 sample products was supposed to be equal to the energy embodied per mass unit in all the products belonging to the same group, including production steps and energy source. However, food actually consumed does not equal the total food produced to satisfy European consumption, as wasted food in the EU has been estimated to be about 100 million tonnes per year [5]. Energy embedded in the wasted food was estimated as the weighted average of food products contained in the whole JRC food basket.

Figure 2 shows the results of such an energy flow analysis in terms of the average energy embedded in the food consumed by each EU citizen, including the amount of energy lost in food wastage, detailed per production step. In total, an energy amount of about 23.6 GJ is embedded in the food consumed in 2013 by each European citizen, equivalent to the gross energy provided by 655 litres of Diesel fuel. Considering a population of 502.5 million people, the overall amount of energy embedded in the food consumed in EU-27 in 2013 is estimated to 11 836 PJ (283 Mtoe), equivalent to 17 % of the EU-27's gross energy consumption and 25.7 % of its final energy consumption in 2013.

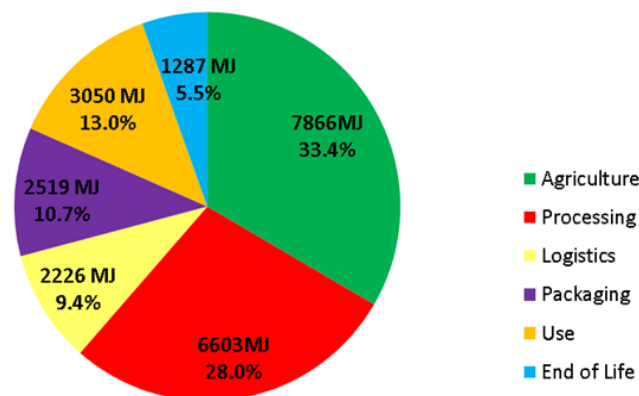
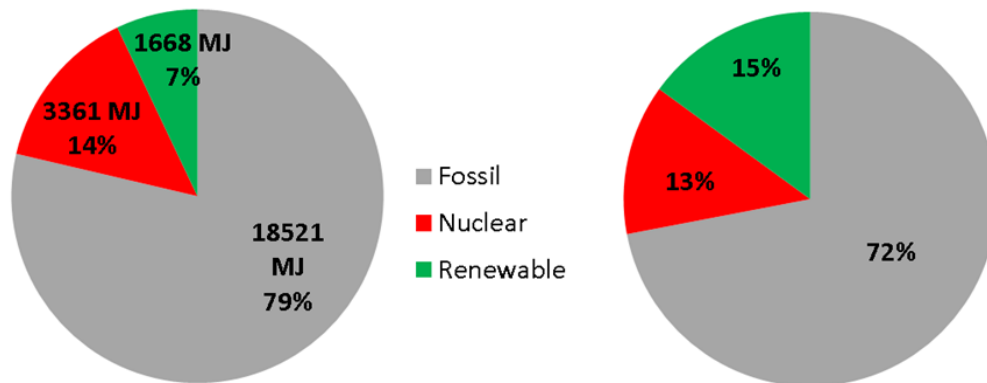

Figure 2: Energy embedded in the food consumed by the average EU-27 citizen, broken down by food production step

Such an estimate is equal to the figure of 17% of energy consumption in the UK related to food production reported [6] and it is also consistent with FAO evaluations [7] when applied to strongly industrialised areas. Agriculture, including crop cultivation and animal rearing, is the most energy intense phase of the food system—accounting for nearly one third of the total energy consumed in the food production chain. The second most important phase of the food life cycle is industrial processing, which accounts for 28% of total energy use. Together with logistics and packaging, these three phases of the food life cycle "beyond the farm gate" are responsible for nearly half of the total energy use in the food system. In total, about 60 % of the energy embodied in European food derives from agriculture and logistics, two sectors largely dominated by fossil fuels in which the penetration of renewable energies is still relatively small.

Figure 3: Energy embedded in the food consumed by the average EU citizen in 2013, detailed per energy source (left) compared to the overall EU energy consumption mix in 2013 (right)



Consistently, about 80 % of the total energy associated with the entire food life cycle originates from fossil fuels (Figure 3 - left side), while all renewable energy sources account for 7.1 %. The overall EU-27 energy consumption mix in 2013 (Figure 3 — right-hand side) shows a RE share around 15 % and a 72 % contribution from fossil fuels. Thus, while the EU has made important progress in incorporating renewable energy across the economy, the share of renewables in the food system remains relatively small. Possible solutions and pathways for improvement are extensively discussed in the report.

## 5. Conclusions and way ahead

Energy efficiency in agriculture production is steadily improving (direct energy consumption per hectare has declined by about 1% every year in the last two decades) but additional array of responses across the food system are still needed. Energy remains a crucial input for cultivation success but huge improvements are possible. European farmers are already leading the way in this transition, for example, through efforts to increase the use self-produced renewable energy in agriculture. Thanks to investments in farm-based technologies like biogas, farmers have the potential to not only become energy self-sufficient, but also to make a major contribution to EU energy production while reducing GHG emissions. The EU food industry is also giving important contributions to make their activities more sustainable, through both increased investment in renewable energy and energy efficiency improvements. The food industry's energy consumption from 2005-13 has declined, both in absolute terms as well as in terms of energy intensity, producing more while using less energy. Policies should continue to lead this process.



## 6. References

- [1] JRC (2015) Energy use in the EU food sector: State of play and opportunities for improvement, Report EUR 27247 EN
- [2] EC-JRC (2014) Indicators and targets for the reduction of the environmental impact of EU consumption: Basket-of-products indicators and prototype targets for the reduction of environmental impact of EU consumption. Deliverable 5 from EC.JRC to DG ENV , JRC Contract No. 33431
- [3] Notarnicola, Tassielli G., Renzulli P.A., 2015. Update of the structural analysis of EU food consumption: Selection of representative products Notarnicola, Tassielli G., Renzulli P.A., 2015. Update of the structural analysis of EU food consumption: Selection of representative products for the basket and analysis of the embedded energy and its related GHG emissions. Technical report commissioned by the Institute for Energy and Transport (European Commission – Joint Research Centre).
- [4] Frischknecht, R.; Jungbluth, N.; Althaus, H.J.; Doka, G.; Dones, R.; Hischier, R.; Hellweg, S.; Humbert, S.; Margni, M.; Nemecek, T.; Spielmann, M. 2007. Implementation of Life Cycle Impact Assessment Methods: Data v2.0.ecoinvent report No. 3, Swiss centre for Life Cycle Inventories, Dübendorf, Switzerland.
- [5] EC (2015) Food Waste, 2015. Retrieved from [http://ec.europa.eu/food/safety/food\\_waste/index\\_en.htm](http://ec.europa.eu/food/safety/food_waste/index_en.htm)
- [6] DEFRA (2013) Agriculture in the United Kingdom 2012, Retrieved from <https://www.gov.uk/government/statistics/agriculture-in-the-united-kingdom-2012>
- [7] FAO (2013) Climate-Smart Agriculture Sourcebook, Food and Agriculture Organization of the United Nations (FAO), Rome. Retrieved from <http://www.fao.org/docrep/018/i3325e/i3325e.pdf>

# Energy Flows and Greenhouses Gases of EU national breads using LCA approach

Giuseppe Tassielli<sup>1</sup>, Bruno Notarnicola<sup>1</sup>, Fabio Monforti-Ferrario<sup>2</sup>, Pietro A. Renzulli<sup>1</sup>

<sup>1</sup>Ionian Department of Law, Economics and Environment, University of Bari Aldo Moro, Bari, Italy

<sup>2</sup>European Commission, Joint Research Centre, Centre, Renewable Energy Unit,

Via Enrico Fermi 2749; T.P. 290; I-21027 Ispra (VA), Italy

E-mail contact: giuseppe.tassielli@uniba.it

## 1. Abstract

*The project described encompasses a life cycle evaluation, in terms of energy flows and greenhouse gas emissions related to 21 types of EU bread. The work involved building a common framework with respect to the assumptions and models to be used for the single product assessments in order to achieve consistent LCAs and to obtain comparable results. The system was divided into seven parts: agriculture/breeding, storage, wheat/rye milling, ingredients production, logistics, packaging, bread production. The results show that in both the indicators the breads which have simple recipes, characterised by the presence of flour, water and yeast have the best energy and global warming results. On the contrary, the breads which have more complex recipes, characterised by the presence of animal-based products have the worst results. In all the cases, the energy consumption due to the baking process represents a hot spot.*

## 2. Introduction

This project is part of the scientific support of the EU Joint Research Centre (JRC) for the EXPO 2015 in the field of energy use and sustainable energy solutions in the food sector. Among other things, such support includes the production of content and data to be inserted in the interactive and visual material aimed at completing the experience of the visitors of the EU pavilion ( <http://europa.eu/expo2015/> ) and to be used to illustrate the diversity of nutrition habits across the European Union.

The aim of this work is to provide estimates about the energy flows and the greenhouse gases (GHG) emissions associated with the production of 21 types breads, consumed in the EU, following an LCA approach. In order to calculate the energy flows and GHG emissions related to the bread types, process-based life cycle inventory models were developed, following an LCA "from-cradle-to gate" approach.

The methodological starting point for this project have been the reports of the preceding "basket of product" LCA studies developed by the Institute for Environment and Sustainability (IES) of the JRC [1] therefore for this project, the methodology already developed in the previous JRC studies was followed as closely as possible.

## 3. Method

The first step of the work involved building a common framework with respect to the assumptions and models to be used for the single product assessments in order to achieve consistent LCAs and to obtain comparable results. The next step was the development of the process-based life cycle inventory models for the products and of the corresponding process-based life cycle inventories. The functional unit is defined as 1 kg of bread ready to be sold in an artisanal bakery.

The system was divided into seven parts: agriculture/breeding, storage, wheat/rye milling, ingredients production, logistics, packaging, bread production. The LCI datasets were constructed based on foreground data obtained from literature, direct industry sources and background data mainly was taken from the Agrifootprint [2] and Ecoinvent v.3 [3] databases. As regards to wheat production, the environmental datasets for each (producing and exporting) country was built using different data sources such as the IFA database [4], which provides data on the fertiliser consumption per country, the FERTISTAT database [5] which provides data on the specific consumption of fertilisers in the cultivation of wheat for different countries and the FAOSTAT database [6] which was used to obtain the yields of grain per hectare in the various countries.

In the last step of the work two indicators were developed: Energy Consumption derived from the calculation of the energy flows and the Global Warming Potential which are derived from the calculation of the Greenhouse Gas Emissions of the twenty one EU breads.

#### **4. Results, discussion and conclusions**

Table 1 illustrates the ingredients of the 21 breads object of the study. The main results concerning the Energy Consumption and GWP for each of the 21 types of bread are illustrated in Figure 1. The results show that in both the indicators the breads which have simple recipes, characterised by the presence of flour, water and yeast have the best energy and global warming results. On the contrary, the breads which have more complex recipes, characterised by the presence of animal-based products as cheese, butter, milk, cream and eggs have the worst results. In all the cases, energy consumption in bread production (baking process) represents a hot spots. Differences in energy consumption among breads reach up a factor of three for both the indicators with embedded energy ranging from 9 MJ/kg to 37 MJ/kg. In comparison the 'average' European bread included in the JRC food basket studied in [7] has an embedded energy of 16.1 MJ/kg. In both the indicators French Baguette (9.05 MJ and 0.46 kg CO<sub>2</sub> eq.) Greek Pita and the Italian Focaccia, result as the most energy and carbon friendly, mostly due to the simplicity of their recipes, made up by wheat flour, water and yeast, without any animal-derived ingredient. Moreover in the case of France, the lowest GHGs is also due to its electricity mix, which is largely based on nuclear power.

Hungaria Pogácsa and Romania Pascã (37.1 MJ and 6.59 kg CO<sub>2</sub>eq.) breads have very high burdens in both the indicators due to the animal-derived ingredients, especially cheese, but also butter and cream and to the high energy consumption in the manufacturing and the relative greenhouse emissions in addition to those of CH<sub>4</sub> and N<sub>2</sub>O respectively occurring during the animal breeding and manure management.

Table 1: The ingredients of the 21 breads

Ingredients	Unit	Countries																						
		AT	BE	BG	CZ	EE bre ad	EE ing r.	FR	DE	GR	HU	IE	IT	LV	LT	MT	NL	PL	RO	SK	SI	ES bread	ES ingr.	UK
wheat flour	g	800	430	350	1,000			650	1,000	400	250	450	800			450	500		1,000	1,000	1,000	33		370
rye flour	g					210							1,280	2,225			1,050							
bread	g					300																60		
butter	g		85	60		28		80		120							40		250		100			85
cheddar cheese	g									90														
cream	g					309				113									250					10
cream cheese	g																	500						
egg yolk	g									15														
eggs	g	62	62	123	123							123					123		369	185				62
fat	g																			350				
honey	g										8			64					50					
jam	g					262																		20
mashed boiled potato	g									100														
milk	g		214	120	500			260			350						275		300		400			175
milk powder	g																		40					
olive oil	g									14		140										6	2	
raisins	g		250														350		100	25				
salt	g	20	5	5	10	3	10	34	11	3	5	45	20	20	10	10	7	1	10	18	2	1		1
sugar	g	15	45	50		10	71	15				20	60	75		60		125	450	40	1			42
tomatoes	g																						30	
vegetable oil	g	20			250													9						
water	g	430		120		108	400	260	250			700	660	1,130	290		700		370		29			
yeast	g	30	25	9	25	10	20	42	10	1		4	60		11	15		25	50	40				14
<b>total weight of ingredients</b>	<b>g</b>	<b>1,38</b>	<b>1,11</b>	<b>837</b>	<b>1,91</b>	<b>341</b>	<b>970</b>	<b>1,08</b>	<b>1,69</b>	<b>685</b>	<b>693</b>	<b>936</b>	<b>1,71</b>	<b>2,08</b>	<b>3,51</b>	<b>761</b>	<b>1,37</b>	<b>1,76</b>	<b>2,98</b>	<b>2,48</b>	<b>1,60</b>	<b>70</b>	<b>93</b>	<b>779</b>

Figure 1: Energy Consumption (left – MJ/kg) and Global Warming Potential (right – kg CO<sub>2e</sub>/kg) for the 21 types of EU breads

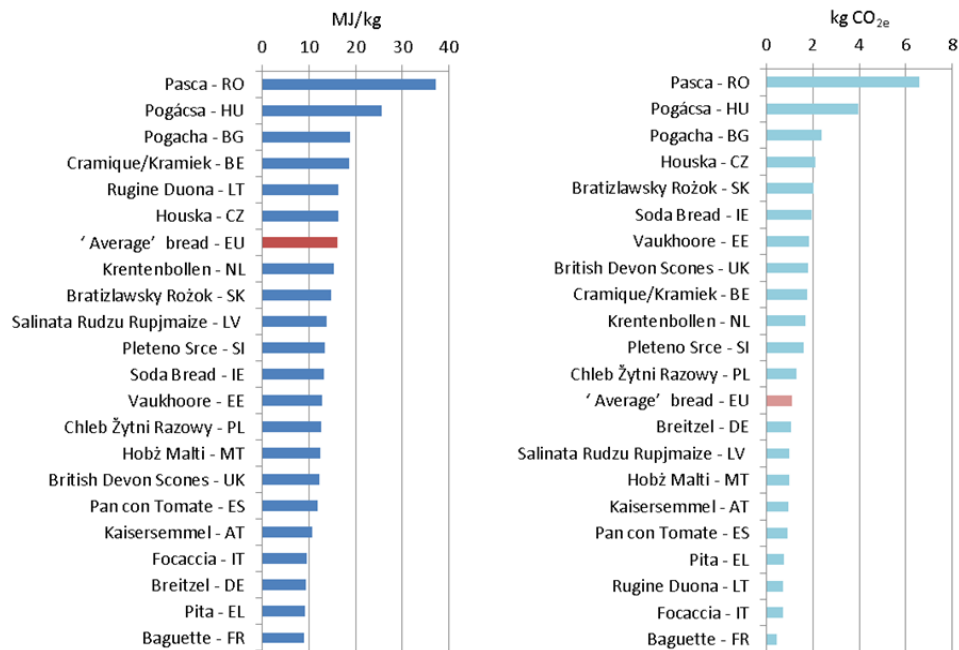

## 6. References

- [1] Notarnicola B., Tassielli G., Renzulli P.A. 'A structural analysis of EU food consumption: Selection of representative products for the basket and analysis of the environmental impacts by LCA.' Technical report, 2014. European
- [2] Commission, Joint Research Centre, Institute for Environment and Sustainability.
- [3] Blonk Consultants (2014). Agri-footprint Description of data. V 1.0. Retrieved from: [www.agrifootprint.com/assets/Agri-Footprint-Part2-Descriptionofdata-Version1.0.pdf](http://www.agrifootprint.com/assets/Agri-Footprint-Part2-Descriptionofdata-Version1.0.pdf)
- [4] Frischknecht R., Jungbluth N., Althaus H.-J., Doka G., Dones R., Heck T., Hellweg S., Hischier R., Nemecek T., Rebitzer G. and Spielmann M. (2007). Overview and Methodology. ecoinvent report No. 1, v2.0. Swiss Centre for Life Cycle Inventories, Dübendorf, CH, retrieved from: [www.ecoinvent.org](http://www.ecoinvent.org).
- [5] IFA (2012). Database of the International Fertilizer Industry Association available at <http://ifadata.fertilizer.org/ucSearch.aspx>
- [6] FertiStat, 2004. Fertilizer use by crop statistics. Available at: [http://www.fao.org/ag/agp/fertistat/fst\\_fubc\\_en.asp](http://www.fao.org/ag/agp/fertistat/fst_fubc_en.asp)
- [7] FAOSTAT, 2013. Food and Agriculture Organization of the United Nations. Statistics Division. Available at: <http://faostat3.fao.org/home/E>
- [8] JRC, 2015, Energy use in the EU food sector: State of play and opportunities for improvement, Report EUR 27247 EN

# Life Cycle Assessment for Enhancing Environmental Sustainability of Sugarcane Biorefinery in Thailand

Thapat Silalertruksa<sup>1,2</sup>, Shabbir H. Gheewala<sup>1,2</sup> and Patcharaporn Pongpat<sup>1,2</sup>

<sup>1</sup> The Joint Graduate School of Energy and Environment, King Mongkut's University of Technology Thonburi, 126 Prachauthit, Bangmod, Tungkru, Bangkok 10210, Thailand

<sup>2</sup> Center of Energy Technology and Environment, Ministry of Education, Bangkok, Thailand

E-mail contact: [thapat.sil@kmutt.ac.th](mailto:thapat.sil@kmutt.ac.th)

## 1. Abstract

*The study assesses the environmental sustainability of sugarcane biorefinery systems expressed in terms of potential environmental impacts. The biorefinery system includes sugarcane cultivation and harvesting, sugarcane milling and by-product utilization i.e. bagasse for steam and electricity, molasses for ethanol, and vinasse for soil conditioner. The results revealed that the improvement of sugarcane cultivation and harvesting practice e.g. green cane production along with integrated utilization of biomass residues through the entire chain as a biorefinery would help reduce the environmental impacts of the main products derived from sugarcane e.g. sugar and ethanol. The potential impacts on climate change, acidification, photo-oxidant formation and particulate matter formation could be reduced by around 43%, 66%, 93% and 68%, respectively. GHG implications of low productivity paddy field conversion to sugarcane and environmental hotspots have been identified for encouraging sustainable sugarcane industry in the future.*

## 2. Introduction

The Thai Government has launched the 10-Year Alternative Energy Development Plan (AEDP) by setting a target that renewables will contribute 25% of the country's energy mix by 2021. Under the AEDP, different types of renewable energy sources are promoted including bioenergy such as electricity from biomass and biofuels like bioethanol. The sugarcane and sugar industry is expected to play an important role as a bioenergy supplier for Thailand in the future because sugarcane has a high proportion of biomass especially in the form of readily fermentable sugars that can be used for biofuels. The sugarcane industry is complex and consists of various forms of biomass e.g. sugar, bagasse, cane trash, molasses, and filter cake that need to be suitably managed. To enhance the benefits of sugarcane biomass utilization, the production system that integrates biomass conversion processes to produce fuels, heat, electricity and value-added products from biomass, or so called "biorefinery", is therefore gaining attraction for the sugarcane industry nowadays e.g. the sugar-ethanol-electricity mills and the integrated 1<sup>st</sup> and 2<sup>nd</sup> generation ethanol production [1-3].

## 3. Methodology

The study aims to assess the environmental performance of two sugarcane biorefineries (sugar-power-ethanol production) in Thailand using Life Cycle Assessment (LCA). The "ReCiPe" impact assessment methodology has been referred [4].

### 3.1 System boundary

The scope of assessment including land use and management for sugarcane cultivation and harvesting, transport of sugarcane, sugar milling, steam and power generation from bagasse, molasses ethanol

production, raw material production and vinasse and filter cake for soil conditioner (Figure1). Two biorefinery systems i.e. (1) base case and (2) improvement scenario are evaluated. The base case represents the conventional farming practices with cane trash burning, sugar milling, molasses ethanol production and steam and power generation from bagasse. Per tonne of cane processed, the final products obtained from the base case biorefinery system are 53 kg of raw sugar, 56 kg of refined sugar, 10.2 litres of molasses ethanol and 3.5 kWh surplus electricity sold to the grid. The improvement scenario shows the case where biomass utilization is improved by the mechanized sugarcane farming and 50% of cane trash is recovered for electricity generation in the power plant. In addition, vinasse from the ethanol conversion process is used to produce fertilizers. This improvement biorefinery scenario brings about the additional benefits i.e. 14.7 kWh of surplus electricity from cane trash recovery and 112 litres of vinasses used as organic fertilizers as compared to base case.

Figure 1 : System boundary of the studied sugarcane biorefinery

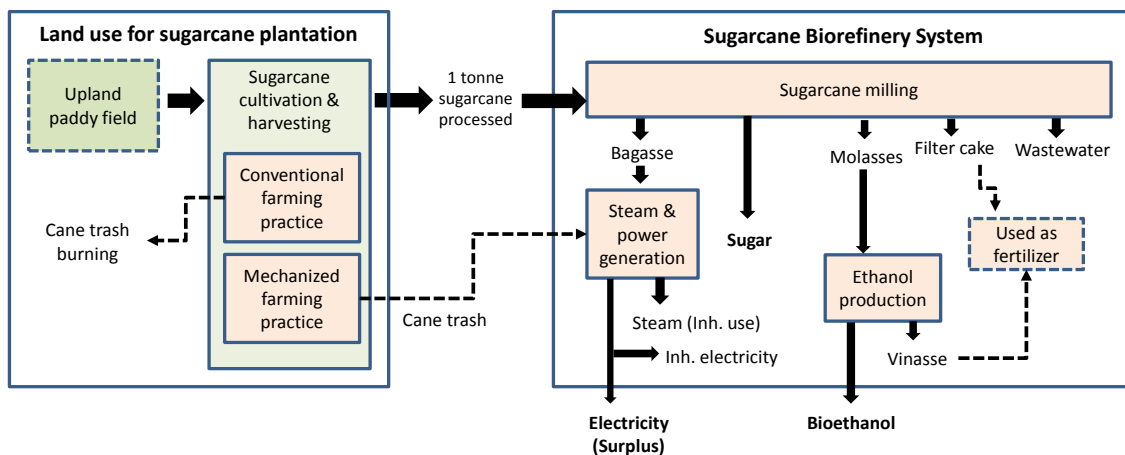

### 3.2 Data sources

Life cycle inventories (LCIs) of sugarcane farming with both conventional and mechanized farming practices were collected from sugarcane growers in the Northeastern region of Thailand. Production data of sugarcane milling, steam and power generation plant and molasses ethanol production plant were also collected from the plants located in the Northeastern region of Thailand complemented with literature [5]. LCIs for the materials, chemicals, and fuels used were referred from the Thai national LCI database [6] and Ecoinvent database [7].

## 4. Results

Table 1 shows the potential environmental impacts for the final products of biorefinery i.e. raw sugar, refined sugar, bioelectricity and molasses ethanol for the base case and the improvement scenario. The results revealed that the improvement of sugarcane cultivation and harvesting practices (e.g. green cane production along with integrated utilization of biomass residues throughout the entire chain as a biorefinery) would help to reduce the environmental impacts of the main products derived from sugarcane e.g. sugar, electricity and ethanol.

The potential impacts on climate change, acidification, photo-oxidant formation and particulate matter formation of all products reduce by around 43%, 66-70%, 93% and 68-71%, respectively. The current practice of cane trash burning before harvesting is the major source of several impacts such as climate change, acidification, photochemical oxidant formation, and particulate matter formation. Promotion of mechanized farming can mitigate those impacts by avoiding cane trash burning although the environmental impacts from diesel consumption would increase. Utilization of chemical fertilizers has the highest contribution to the eutrophication impact potential as anticipated. Meanwhile, the agrochemicals and chemicals used in the biorefinery are the main contributor to the human toxicity impact potential.

*Table 1: Potential environmental impacts of final products obtained from different biorefinery scenarios*

Impact category	Unit	Raw sugar (1 tonne)		Refined sugar (1 tonne)		Bio-electricity (1 MWh)		Molasses ethanol (1000 litres)	
		Base case	Scenario	Base case	Scenario	Base case	Scenario	Base case	Scenario
Climate change	kg CO <sub>2</sub> eq	272	155	337	193	32	18	391	225
Terrestrial acidification	kg SO <sub>2</sub> eq	2.2	0.7	2.7	0.8	0.3	0.1	3.3	1.1
Freshwater eutrophication	kg P eq	0.05	0.04	0.06	0.05	0.01	0.01	0.07	0.07
Human toxicity	kg 1,4-DB eq	63	60	78	74	8	7	99	94
Photochemical oxidant formation	kg NMVOC	5.5	0.4	6.9	0.5	0.7	0.05	8.0	0.6
Particulate matter formation	kg PM10 eq	0.8	0.2	1.0	0.3	0.1	0.03	1.2	0.4
Terrestrial ecotoxicity	kg 1,4-DB eq	0.03	0.03	0.04	0.04	0.004	0.004	0.05	0.05
Freshwater ecotoxicity	kg 1,4-DB eq	1.6	1.5	2.0	1.9	0.2	0.2	2.5	2.3

For the new government policy on conversion of low productivity paddy fields to sugarcane, the conversion would induce the soil organic carbon stock changes because the land management activities (e.g. fertilizer input factors, tillage practice and management practice of farmers) will be changed. Based on the IPCC (2006) methodology [8], direct land use change from paddy field to sugarcane in the Northeastern region of Thailand led to soil carbon loss of about 0.8 tC/ha-yr; however, sugarcane will be planted as ratoons for the next three years which possibly increases carbon stock to about 0.15 tC/ha-yr. The net GHG emissions from land-use change of paddy rice to sugarcane would be about 2.6 tCO<sub>2</sub>eq/ha-yr. Nevertheless, the green manure application and utilization of vinasse as organic fertilizer potentially reduced the GHG emissions from soil carbon stock change by around 5%. Thus, good agricultural practices for land preparation and sugarcane plantation should also be encouraged to farmers.

## 5. Conclusion

The results revealed that the improvement of sugarcane cultivation and harvesting practices (e.g. green cane production along with integrated utilization of biomass residues throughout the entire chain as a biorefinery) would help to reduce the environmental impacts of products derived from sugarcane e.g. sugar and ethanol. The potential impacts on climate change, acidification, photo-oxidant formation and particulate matter formation reduce by around 43%, 66%, 93% and 68%, respectively. Hotspots identified provide important information for policy makers towards enhancing sustainable sugarcane production in the future.



## 6. Acknowledgment

The authors would like to acknowledge the financial support from the National Science and Technology Development Agency (NSTDA) through the research project “Research Network for LCA and Policy on Food, Fuel and Climate Change” (Grant no. P-12-01003).

## 7. References

- [1] Gheewala, S.H., Bonnet, S., Prueksakorn, K. and Nilsalab, P. ‘Sustainability Assessment of a Biorefinery Complex in Thailand’. *Sustainability* 3 (2011) 518-530.
- [2] Dias, M.O.S., Junqueira, T.L., Cavalett, O., Pavanello, L.G., Cunha, M.P., Jesus, C.D.F., et al. ‘Biorefineries for the production of first and second generation ethanol and electricity from sugarcane’. *Appl. Energ.* 109 (2013) 72–78.
- [3] Silalertruksa, T. and Gheewala, S.H. ‘Environmental sustainability assessment of bio-ethanol production in Thailand’. *Energy* 34 (2009) 1933-1946.
- [4] Goedkoop, M., Heijungs, R., Huijbregts, M., Schryver, A.D., Struijs, J. and Zelm, R.V. ‘ReCiPe 2008: A life cycle impact assessment method which comprises harmonised category indicators at the midpoint and the endpoint level’, 1st Edn (version 1.08). 2013. VROM.
- [5] Wang, L., Quiceno, R., Price, C., Malpas, R. and Woods, J. ‘Economic and GHG emissions analyses for sugarcane ethanol in Brazil: Looking forward’. *Renew. Sust. Energ. Rev.* 40 (2014) 571–582
- [6] MTEC. Thailand National LCI Database. National Metal and Materials Technology Center. 2014. Bangkok.
- [7] Ecoinvent. Swiss Centre for Life Cycle Inventories. Ecoinvent data v3.0. Swiss Centre for Life Cycle Inventories: 2012.
- [8] IPCC. IPCC guidelines for national greenhouse gas inventories, Vol.4, Agriculture, forestry and other land use. IGES. 2006. Hayama.

# Life Cycle Assessment of Biogas Production from Marine Macroalgal Feedstock: Substitution of Energy Crops with Algae

Funda Cansu, Ertem<sup>1</sup>, Peter, Neubauer and Stefan, Junne

<sup>1</sup> Chair of Bioprocess Engineering, Institute of Biotechnology, Technische Universität Berlin,  
Ackerstr. 76, ACK24, 13355 Berlin, Germany  
E-mail contact: [fcertem@mailbox.tu-berlin.de](mailto:fcertem@mailbox.tu-berlin.de)

## 1. Abstract

*Macroalgae is a very hopeful biomass and is likely to play an imperative role in securing energy supply in the following decade. The aim of this paper is to evaluate the biogas production by the substitution of energy crops with macroalgae as feedstock at an industrial scale biogas plant in North Germany. Our results determine the affirmative impact of algae on the greenhouse gas emission reductions. It can be concluded that the biogas production processes depend not only on the biogas yields of the selected feedstock, but also on their climate protection abilities.*

## 2. Introduction

Biomass resources are considered as one of the main renewable energy sources and expected to provide more than half of the energy demand in the near future [1]. Nevertheless, some studies suggest that intensive exploitation of arable lands for the cultivation of energy crops may yield a negative impact on the global stock and prices of foods and lead to increasing quantities of greenhouse gases (GHG) being emitted to the atmosphere [2-4]. For that reason, alternative sources of biomass for energy purposes that would be both economic and environment-friendly are needed. Considering a high photosynthetic effectiveness, a fast biomass growth, resistance to contaminations, algae appears as a competition to typical energy crops [5-7]. In this respect, the use of macroalgae to produce energy appears to be a promising practice to complement and secure energy supply. As concerns, this paper presents an assessment of the environmental consequences of biogas production when the energy crops are replaced with macroalgae (brown and red algae) as feedstock at an industrial scale biogas plant in Northern Germany. As we know there is no study that evaluated the environmental impacts of harvesting the algae from coasts in Germany for biogas production. This approach would reduce eutrophication in marine environment by producing bioenergy from macroalgal biomass.

## 3. Methods

Life cycle assessment (LCA) is a method that quantitatively assesses the environmental damages of all elementary process steps. The standard ISO 14040:2006, which gives the basis for LCA procedures, was pursued in this study [8]. The scope of the scenarios is site-specific for Northeast Germany.

Fig 1 presents the current production system with energy crops B) and an alternative production way with macroalgae A). The system involves the collection/production and storage of feedstock, digestion, storage/handling of digestate, electricity and heat generation from biogas, and lastly the transport. Animal production was not considered.

### 3.1 System boundary

Figure 1: System boundary: Energy production with a) Macroalgae and b) Energy crops. Adapted from KTBL [9]

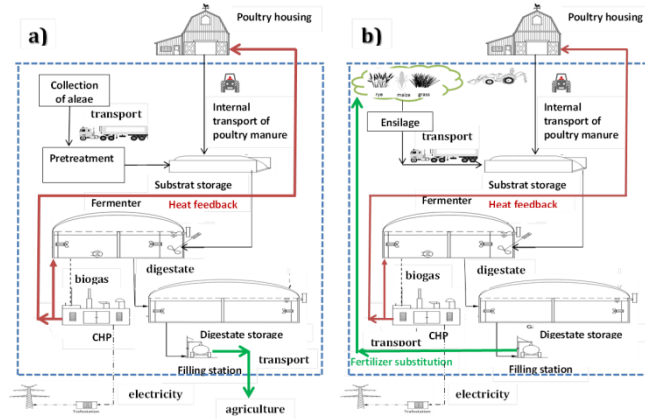

### 3.2 Life cycle inventory analysis

#### 3.2.1 Determination of feedstock amounts and compositions

Table 1: Characteristics of the feedstock

Feedstock	Macroalgae	Maize	Rye	Grass	Poultry manure
<b>Total Solid - TS (% FM)</b>	24.8	33	25	35	40
<b>Organic Total Solid - oTS (% TS)</b>	80	95	89	90	75
<b>Gas yield (m<sup>3</sup>t<sup>-1</sup> FM)</b>	993	270	245	255	225
<b>Methane content (%)</b>	60	52	53	53	55

The quantity of macroalgae to substitute the energy crops was determined based on the biogas yields. The collation depended on functional unit (FU) (1 kWh energy production), which provides a reference, to which the input and output can be related, was performed. Characterization of the feedstock, the total solid (TS), organic total solid (oTS) and the biogas yields were determined based on literature data [9-11] (Table 1).

#### 3.2.2 Feedstock

Yearly, 2190 tons maize, 657 tons rye and 4380 tons grass were cultivated on 360 ha agricultural areas. Table 2 provides an overview of the required input for the cultivation. Following the harvest period, crops were ensiled for 6 months and then transported to the biogas plant. The transport (12 km) was done by a truck consuming 40 L h<sup>-1</sup> Diesel. In order to replace energy crops, 1400 tons of macroalgae was collected from Northern coastal (Baltic Sea) of Germany. The collection was done by a tractor with fork, collection capacity of 45 m<sup>3</sup>h<sup>-1</sup> and consuming 12 L Diesel h<sup>-1</sup> [12]. The collected algae were then transported (150 km) by 40 ton capacity truck. 2.5 tons of daily produced manure at poultry housing is transported by tractor to the storage. The loading capacity was 250 kg and the Diesel consumption was 40 L h<sup>-1</sup>.

### 3.2.3 Pretreatment of algae

Table 2: Basic data for the cultivation of the crops

	Maize	Rye	Grass
<b>Sowing</b>	1-10 May	1-10 October	1-20 April
<b>Harvest</b>	20-30 September	20-30 June	Cut 1: 1 April; cut 2: 1 July; cut 3: 1 October
<b>Input (kg ha<sup>-1</sup>)</b>			
<b>Seed amount</b>	28	110	40
<b>Herbicide</b>	3	3	1
<b>N fertilizer</b>	166	130	38
<b>P<sub>2</sub>O<sub>5</sub> fertilizer</b>	72.7	75	70
<b>K<sub>2</sub>O fertilizer</b>	180	170	220

Mechanical pretreatment was assumed to be applied as described in [7], which consumes 38 kWh per tons of macroalgae. Moreover, the electrolytic recovery method for heavy metal removing was assumed to be utilized as described in [13], which consumes 61 MW yearly energy.

### 3.2.4 Anaerobic digestion

The biogas plant consists of 3 fermenters with a total volume of 4500m<sup>3</sup> and operates under 42 °C at a total 170 day retention time. Electricity was supplied from the grid. The biogas was used in a 500 kW combined heat and power for the production of electricity and heat. 35% of heat was used for the fermenters and 65% for poultry housing. The digestate was transported to the agricultural area by 40 ton capacity truck and then it was used in the agricultural production. When macroalgae were used, digestate application was excluded from the system, since there is no more agricultural production.

### 3.3 Life cycle impact assessment

All resources were included in the assessment and categorized under four environmental indicator potentials: global warming (GWP) in kg CO<sub>2</sub>-eq, acidification (AP) in kg SO<sub>2</sub>-eq, eutrophication (EP) in kg P-eq, and land transformation (LTP) in m<sup>2</sup>. The operation was modeled with SimaPro 7.3.2 [14] by using the Ecoinvent 2.2 database. Impact assessments were computed by using the ReCiPe midpoint v.1.06 methodology. To enable the comparison of feedstock, environmental impacts were calculated based on the chosen FU.

## 4. Results

Fig 2 illustrates the comparison of LCA characterization results. The outcomes showed that macroalgae provided highly promising results by means of GHG emissions savings. For the operation with energy crops, the digestate spreading creates the highest AP and EP due to high nitrate and phosphor emissions. Agriculture related activities have the highest LTP because of arable land use and transport. Fuel burning emissions from the transport cause the highest GWP. The substitution of energy crops with macro algae would result in 48%, 82%, 41% and 37% respectively lower GWP, AP, EP and LTP due to the avoidance of digestate spreading. When macroalgae were used, the greatest emission contributor was fermenters (44% of GWP, 32% of AP and 40% of the EP).

Figure 2: The comparison of LCA results for energy production with macroalgae and energy crops based on a) global warming, b) acidification, c) eutrophication and d) land transformation. The results are given per FU

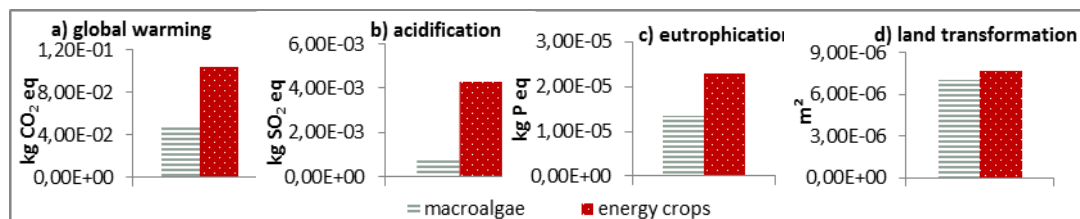

## 5. Conclusions

The outcomes indicate that macroalgae would result in lower environmental impacts. The biogas production systems, their efficiency and environmental impacts depend on the feedstock. Use of algal biomass for bioenergy could recreate favorable conditions on coasts; remove nutrients and heavy metals; and decrease bad smell [15]. Nevertheless, there are still challenges to overcome regarding their collection due to sand amount in the collected material and pretreatments to make them usable in agriculture after digestion.

## 6. References

- [1] European Renewable Energy Council E., Renewable Energy Technology Roadmap 20% by 2020, (2008).
- [2] Fargione J, Hill J, Tilman D, Polasky S, Hawthorne P., Land clearing and the biofuel carbon debt. *Science* (2008);319:1235.
- [3] Searchinger T, Heimlich R, Houghton RA, Dong F, Elobeid A, Fabiosa J, Use of US croplands for biofuels increases greenhouse gases through emissions from land-use change. *Science* (2008);319:1238.
- [4] Johansson DJ, Azar C., A scenario based analysis of land competition between food and bioenergy production in the US. *Climatic Change* (2007);82:267.
- [5] Aitken D, Bulboa C, Godoy-Faundez A, Turrion-Gomez JL, Antizar-Ladislao B., Life cycle assessment of macroalgae cultivation and processing for biofuel production. *Journal of Cleaner Production* (2014);75:45.
- [6] Lardon L, Hélias A, Sialve B, Steyer J-P, Bernard O. Life-cycle assessment of biodiesel production from microalgae. *Environmental science & technology* (2009);43:6475.
- [7] Alvarado-Morales M, Boldrin A, Karakashev DB, Holdt SL, Angelidaki I, Astrup T., Life cycle assessment of biofuel production from brown seaweed in Nordic conditions. *Bioresource Technology* 2013;129:92.
- [8] International Standardization Organization, ISO 14044: environmental management—life cycle assessment—requirements and guidelines, (2006).
- [9] Kuratorium für Technik und Bauwesen in der Landwirtschaft K. *Wirtschaftlichkeitsrechner Biogas* (2014).
- [10] Fachagentur für Nachwachsende Rohstoffe. Leitfaden Biogas: von der Gewinnung zur Nutzung;[diese Arbeit wurde im Rahmen des Projekts " Handreichung Biogasgewinnung und-nutzung" angefertigt], (2010).
- [11] Ertem FC., Improving Biogas Production By Anaerobic Digestion Of Different Substrates: Calculation of Potential Energy Outcomes, (2011).
- [12] Municipality T., Evaluation of machines for the collection of algae. Wetlands, Algae Biogas—A southern Baltic Sea Eutrophication Counteract Project, South Baltic Program. (2011).
- [13] Stopić S, Friedrich B, Widigdo A., Electrolytic recovery of copper from highly contaminated wastewaters. *Metalurgija* (2007);13:27.
- [14] Consultants Pre., Introduction to LCA with SimaPro 7. Report Version (2008);4.
- [15] Jöborn A, Oscarsson G, Sköld M, Sterner H., Algae in excess—harvesting for life, Final report to the Eu-Life Alga project County council of Västra Götaland (2001).

## **Environmental assessment of wheat and maize production in an Italian farmers cooperative**

Valentina Fantin<sup>1</sup>, Irene Rondini<sup>2</sup>, Serena Righi<sup>2</sup>, Andrea Pasteris<sup>2</sup>, Francesco Coatti<sup>3</sup>, Fabio Passerini<sup>3</sup>, Paolo Masoni<sup>1</sup>

<sup>1</sup>ENEA-Italian National Agency for New Technologies, Energy and Sustainable Economic Development,  
Via Martiri di Monte Sole 4, 40129 Bologna, Italy

<sup>2</sup>University of Bologna, CIRSA (Centro Interdipartimentale di Ricerca per le Scienze Ambientali),  
Via dell'Agricoltura 5, 48123 Ravenna

<sup>3</sup>E&ngi SRL, Via S. Quasimodo 44, 40013 Castel Maggiore (BO)

E-mail contact: [valentina.fantin@enea.it](mailto:valentina.fantin@enea.it)

### **1. Abstract**

*ISO Life Cycle Assessment method was applied to the production of wheat and maize in an Italian farmers' cooperative, with the aim to assess the potential environmental impacts throughout the life cycle of these crops as well as to identify the hotspots in the production chains. The functional units were 1 tonne of wheat and maize and system boundaries were from cradle to cooperative's gate and included the agricultural production, the transport to the cooperative, and the cleaning as well as storage phases. Specific primary data were used in the study. The results according to the CML and UseTox impact assessment methods show that the major hotspot for both crops in almost all impact categories is the agricultural phase, due to fertilisers and pesticides use. Finally, a sensitivity analysis was performed, using different methods for the calculation of on-field nitrogen and pesticides emissions, in order to assess their effects on LCA results.*

### **2. Introduction**

Cereals are still by far the world's most important sources of food [1]. Their cultivation depends on several economic, social and environmental factors. In particular, climate change, water management and land use are critical environmental issues which affect the productivity of cereal production systems [2]. On the other hand, cereal cultivation can have several potential environmental impacts. Because of these reasons, a transition towards sustainable cereal supply and consumption chains is required, which would increase system productivity while decrease its environmental impacts [3].

In this study, ISO LCA method [4, 5] was applied to the production of wheat and maize in an Italian farmers' co-operative with the aim to evaluate their environmental performance throughout their life cycle. Moreover, since the estimation of on-field nitrogen and pesticides emissions due to the use of chemical fertilisers and pesticide products is often a critical issues in LCA studies of agricultural products, a sensitivity analysis was performed, using different methods for their calculation, in order to assess their effects on LCA results.

### **3. Goal and scope of the study**

The goal of this study was to evaluate the potential environmental impacts of the life cycle of wheat and maize production at a farmers' co-operative gate as well as to identify the hotspots in the production chain. The functional units were 1 tonne of wheat and maize at the cooperative's gate, respectively. An attributional approach was applied. System boundaries were from cradle to cooperative's gate and included the agricultural production of both crops, their transport to the cooperative, and the cleaning as well as storage phases at the cooperative premises.

An economic allocation was applied to the production of wheat and straw as well as to the production of maize by-product, which is currently sold on the market.

Specific primary data, referred to 2013, were collected for the following items: consumption of seeds, chemical fertilisers and pesticides, crops yield, consumption of diesel and lubricants, quantity of crops transported to the cooperative and the respective average distances, consumption of energy and water for drying and storage phases, waste production. Airborne emissions due to the agricultural machinery were calculated according to “Non-road mobile sources and machinery” emission factors of the EMEP/CORINAIR Emission Inventory Guidebook [6]. N<sub>2</sub>O and NH<sub>3</sub> airborne emissions as well as NO<sub>3</sub><sup>-</sup> waterborne emissions due to the use of fertilisers were calculated according to the nitrogen balance by Brentrop (2000) [7]. Phosphorus waterborne emissions were estimated according to Nemecek and Kagi (2007) [8]. Emissions due to the use of pesticides were calculated according to Margni et al. (2002) [9], considering different percentage emissions into air and soil (10% and 85% of the active ingredient, respectively). PE and Ecoinvent v.2.0 databases were used for background data.

CML 2001 and USEtox impact assessment methods were used in the study, focusing on the following impact categories: Global Warming (GW), Acidification (AC), Eutrophication (EU), Abiotic Depletion (AD), Ozone depletion (OD), Photochemical Oxidation (PO), Freshwater Ecotoxicity (FE), Human Toxicity (HT).

#### 4. Impact assessment results

Results show that cultivation phase is the main hotspots for both cereals and for all selected impact categories (Table 1). In fact, its contribution to total results is higher than 97% and 91% for wheat and maize, respectively. Transports and processing phase at co-operative’s plant show minor contributions (together lower than 10%). As regards agricultural phase, the major hotspot for both crops in almost all impact categories is the fertilizing phase, due to both the production of chemical fertilisers and the on-field nitrogen and phosphorus emissions.

Table 1: Impact assessment results for the production of 1 tonne of wheat and maize

Impact Category	Unit	Total	Cultivation	Transport	Processing
<b>WHEAT</b>					
Abiotic Depletion	kg Sb eq.	8.8E-04	99%	<1%	<1%
Acidification	kg SO <sub>2</sub> eq.	6.1E+00	99%	<1%	<1%
Eutrophication	kg PO <sub>4</sub> eq.	2.0E+00	99%	<1%	<1%
Global Warming	kg CO <sub>2</sub> eq.	4.5E+02	98%	1%	2%
Ozone Depletion	kg CFC-11 eq.	1.6E-05	99%	<1%	<1%
Photochem. Oxidation	kg C <sub>2</sub> H <sub>4</sub> eq.	1.4E-01	97%	1%	2%
Freshwater Ecotoxicity	CTUe	3.3E+02	99%	<1%	<1%
Human Toxicity	CTUh	8.6E-05	99%	<1%	<1%
<b>MAIZE</b>					
Abiotic Depletion	kg Sb eq.	7.7E-04	99%	<1%	<1%
Acidification	kg SO <sub>2</sub> eq.	1.0E+01	99%	<1%	<1%
Eutrophication	kg PO <sub>4</sub> eq.	4.8E+00	99%	<1%	<1%
Global Warming	kg CO <sub>2</sub> eq.	4.5E+02	91%	1%	8%
Ozone Depletion	kg CFC-11 eq.	1.8E-05	99%	<1%	<1%
Photochem. Oxidation	kg C <sub>2</sub> H <sub>4</sub> eq.	1.8E-01	97%	1%	2%
Freshwater Ecotoxicity	CTUe	3.4E+03	99%	<1%	<1%
Human Toxicity	CTUh	6.8E-05	98%	1%	1%

The only exceptions are FE and HT, in which the production and use of pesticides show remarkable contributions. As far as processing phase is concerned, the refrigerated storage and drying treatment are the major contributions for wheat and maize, respectively.

## 5. Sensitivity analysis

The sensitivity analysis on agricultural phase was performed using different methods for the calculation of chemical fertilisers and pesticides emissions, with the aim to investigate their effects on LCA results. More in detail, nitrogen emissions were calculated with IPCC (2006) [10] and the requirements contained in Product Category Rules (PCRs) for Arable Crops of the International EPD System (2014) [11] (Table 2). As regards pesticides emissions, they were calculated according to Nemecek and Kagi (2007) [8] (100% of the active ingredient is considered to be emitted to soil).

Table 2: On-field nitrogen emissions calculated according to Brentrup, IPCC and PCRs methods

Emission	Unit	WHEAT			MAIZE		
		Brentrup	IPCC	PCRs	Brentrup	IPCC	PCRs
$NH_3$	kg/ha	1.9E+01	2.1E+01	1.9+01	4.2E+01	2.8E+01	4.2E+01
$N_2O$	kg/ha	3.0E+00	3.3E+00	3.39E+00	3.8E+00	4.5E+00	4.5E+00
$NO_3$	kg/ha	1.6E+01	2.3E+02	2.3E+02	1.9E+02	3.1E+02	3.1E+02

The outcome of the sensitivity analysis for nitrogen emissions shows that the more complex and accurate method by Brentrup (2000) [7], which was adopted for the base case and requires detailed agricultural, climatic and soil information, leads to lower results in GW, AC and EU of the agricultural phase (Table 3). As regards GW, the adoption of IPCC and PCRs models in both cereals lead to 5-14% and 5% higher results, respectively, if compared to the base case, due to higher  $N_2O$  emissions. The adoption of IPCC for wheat results in a 16% higher value in AC, compared to to the base case, due to higher  $NH_3$  emissions, whereas the AC results of maize are 28% lower. On the contrary, the PCR models lead to very similar results in AC for both crops, if compared to the base case. Finally, the results of EU by using the IPCC and PCR methods are 17-115% and 30-170% higher than the base case, respectively, due to higher  $NO_3$  emissions. Our results confirm the findings of Fusi and Bacenetti (2014) [12] which highlight that ‘Brentrup method’ provides more accurate (i.e less conservative) results.

Table 3: Impact assessment results of the agricultural phase according to Brentrup, IPCC and PCRs methods.

Impact Category	Unit	WHEAT			MAIZE		
		Brentrup	IPCC	PCRs	Brentrup	IPCC	PCRs
Acidification	kg $SO_2$ eq.	6.0E+00	7.0E+00	6.4E+00	1.0E+01	7.2E+00	1.0E+01
Eutrophication	kg $PO_4$ eq.	2.0E+00	4.4E+00	5.5E+00	4.8E+00	5.6E+00	6.2E+00
Global Warming	kg $CO_2$ eq.	4.4E+02	5.0E+02	4.6E+02	4.1E+02	4.4E+02	4.4E+02

The results of sensitivity analysis for pesticides emissions show that Margni (2002) and Nemecek and Kagi (2007) models lead to similar results in both FE and HT, with the exception of HT for wheat (-30%). This can be explained considering that: 1) both models assume that most of pesticide applied is deposited on soil (100% and 85%, respectively); 2) the USEtox characterization factors for air emissions and soil emissions



are similar for the most of active ingredients. Moreover, it is worth noting that the USEtox model does not provide characterization factors of several active ingredients in both FE and HT impact categories (about 40% and 75% of mass of pesticides used in this case-study were not available, respectively).

*Table 4: Ecotoxicity and Human Toxicity results for the agricultural phase according to Margni and Nemecek and Kagi models*

<i>Impact Category</i>	<i>Unit</i>	<i>WHEAT</i>		<i>MAIZE</i>	
		<i>Margni</i>	<i>Nemecek and Kagi</i>	<i>Margni</i>	<i>Nemecek and Kagi</i>
Ecotoxicity	CTUe	3.3E+02	3.3E+02	3.4E+03	3.7E+03
Human toxicity	CTUh	8.5E-05	5.9E-05	6.7E-05	6.7E-05

## 6. Conclusion

The results according to the CML and USEtox impact assessment methods showed that the major hotspot for both crops in almost all impact categories is the agricultural phase, due to fertilisers and pesticides use. The results of the sensitivity analysis on nitrogen emissions showed that the application of different methods lead to different values of nitrate and ammonia, which affect AP and EP results. In fact, ammonia emissions according to Brentrup are 33% higher if compared to IPCC method, due to a higher emission factor for urea. Moreover, nitrate emissions according to Brentrup, whose calculation require more detailed information, are 14 times lower than IPCC and PCRs values. As regards pesticides emissions, the use of different methods leads to similar results in Toxicity impact categories.

## 7. References

- [1] FAO. 2002. World agriculture: towards 2015/2030. Summary report, FAO Rome, pp. 106.
- [2] FAO 2011. Climate change, water and food security. FAO water reports 36
- [3] Notarnicola B., Tassielli G., Renzulli P.A., Lo Giudice A., 2015. Life Cycle Assessment in the agri-food sector: an overview of its key aspects, international initiatives, certification, labelling schemes and methodological issues. In: Life cycle Assessment in the Agri-food Sector - Case studies, Methodological Issues and Best Practices, Edited by Notarnicola B., Salomone R., Petti L., Renzulli P.A., Roma R., Cerutti A.K. Eds, 01/2015: Springer International Publishing, ISBN: 978-3-319-11939-7.
- [4] International Organization for Standardization (ISO), 2006a. Environmental management- Life Cycle Assessment- Principles and Framework. ISO 14040.
- [5] International Organization for Standardization (ISO), 2006b. Environmental management- Life Cycle Assessment- Requirements and guidelines. ISO 14044.
- [6] Winther, M., Samaras, Z., 2013. Non-road mobile sources and machinery. EMEP/EEA emission inventory guidebook 2013, 1-74
- [7] Brentrup F., Kusters J., Lammel J., Kuhlmann H., 2000. Methods to estimate on-field nitrgone emission from crops production as an input to LCA studies in the agricultural sector. International Journal of Life Cycle Assessment, vol. 16 (issue 7). 639-651.
- [8] Nemecek, T., Kägi, T., 2007. Life Cycle Inventories of agricultural Production Systems. Data v2.0. Ecoinvent report n. 15. Swiss Centre for Life Cycle Inventories. Zurich and Dubendorf, Switzerland.
- [9] Margni M., Rossier D., Crettaz P., Jolliet O., 2002. Life cycle impact assessment of pesticides on human health and ecosystems. Agriculture Ecosystems & Environment, vol. 93. 379-392.
- [10] Intergovernmental Panel for Climate Change (IPCC), 2006. 2006 IPCC Guidelines for National Greenhouse Gas Inventories: volume 4: Agriculture, Forestry and other Land Use.
- [11] International EPD System, 2014. Product Category Rules according to ISO 14025:2006, 2014. Product Group: UN CPC 011, 014, 017, 019 Arable Crops. Version 1.01.
- [12] Fusi A., Bacenetti J., 2014. Confronto tra modelli per la stima delle emissioni da fertilizzanti: il caso del mais da granella. In Proceedings of VIII conference of Italian LCA Network. ISBN 978-88-8286-306-7.

# Protein quality as functional unit – a methodological framework for inclusion in Life Cycle Analysis (LCA)

*Ulf Sonesson<sup>1</sup>, Anna Flysjö<sup>2</sup>, Anna-Karin Modin-Edman<sup>2</sup>, Jenny Gustavsson<sup>1</sup>, Anna Hessle<sup>3</sup>, Mikaela Patel<sup>4</sup>,  
Anna Woodhouse<sup>1</sup> and Cornelia Witthöft<sup>5,6</sup>*

<sup>1</sup>SP Technical Research Institute of Sweden, Food and Bioscience, P.O Box 5401, 40229 Göteborg, Sweden

<sup>2</sup>Arla Foods a.m.b.a, Sønderhøj 14, 8260 Viby J, Denmark

<sup>3</sup>SLU - Swedish University of Agricultural Sciences, Dept. of Animal Environment and Health,  
P.O Box 234, 53223 Skara, Sweden

<sup>4</sup>SLU - Swedish University of Agricultural Sciences, Dept. of Animal Nutrition and Management,  
P.O Box 7024, 75007 Uppsala, Sweden

<sup>5</sup>SLU - Swedish University of Agricultural Sciences, Dept. of Food Science, P.O Box 7051, 75007 Uppsala, Sweden

<sup>6</sup>LNU – Linnaeus University, Dept. of Chemistry and Biomedical Sciences, 39182 Kalmar, Sweden

*E-mail contact: [ulf.sonesson@sp.se](mailto:ulf.sonesson@sp.se)*

## 1. Abstract

*The functional unit (FU) of foods has always been a topic of discussion within life cycle analysis (LCA) of foods. The main issue is the complexity of foods, both their multiple environmental impacts and their multiple nutritional values. As a result, no FU covering the actual functions have been developed. Nutrition is complex in itself with the large number of nutrients involved. The value of a certain nutrient in a single product is not static; it depends on the dietary context. We focus on nutritional value, and choose protein content and quality as basis. Protein supply is a critical aspect of food security, and protein can be produced by different means, with different environmental impacts and different quality in terms of amino acid profile and digestibility. We have developed a methodology that considers the content and quality of protein, the digestibility and the dietary context. The result is “g quality weighted protein index/kg product (PQI)”, specific for the diet of which the product is part.*

## 2. Introduction

It has become evident that diets are important for sustainable lifestyles in the sense that adapting diets can be an efficient way of reducing the environmental impact and resource use linked to our food consumption [e.g. 1, 2, 3]. Many studies report that replacing meat with vegetable proteins is the most efficient way to improve the environmental sustainability of food consumption. There are a few studies presenting methods to quantify the more complex nutritional value of foods. Drewnowski *et al.* [4] developed a method of quantifying the nutritional density of food products based on dietary requirements for a large number of nutrients, hence creating a functional unit (FU) covering nutritional content and nutritional demands. However, the nutritional value must be assessed in the context of the actual consumption, *i.e.* the diet. Nutrients cannot be said to have an absolute nutritional value, it depends on the overall diet. Dietary shifts are certainly important to make food systems more sustainable, but many stakeholders need tools to work with single products. The life cycle analysis (LCA) methodology also needs such tools to manage the nutritional value for a single product. We have developed a methodology to include the nutritional value for a single product in a given dietary context. The method is developed based on needs and supply of single essential amino acids (EAA), but the approach is relevant for combinations of nutrients.

### 3. Methods

The method covers the digestible intake of EAA from the product under study and relates it to the total digestible intake of EAA as well as the dietary need for EAA. The method is a step-wise procedure: 1) The content of nine EAA [5] in a product is quantified and multiplied with the EAA specific true ileal human digestibility for that product [6]; 2) the total intake of these EAA in a specific two-week-diet is quantified; 3) the product specific EAA digestible intake is divided by the total dietary intake for that EAA, giving the product's contribution to total intake for each EAA; 4) the total dietary intake of an EAA is divided by the nutritional requirement for that EAA, which gives a ratio describing over/under-consumption for the diet, 5) For each EAA from each product, the proportion of total intake is divided by the over/under-consumption ratio. The values for each EAA for the product are finally added together and the sum is the weighted protein quality index/kg product (PQI) for the product in that dietary context. The PQI illustrates the importance of the studied product as an EAA provider in the specific dietary context. If a product contributes EAA which are lacking in the diet, the PQI of that specific product will be higher, and *vice versa*. The dietary context is hence central for the PQI. Figure 1 depicts the algorithm described above.

Figure 1: Principal description of the method for quantifying the Protein Quality Index (PQI).

Numbers refer to the description in the text above

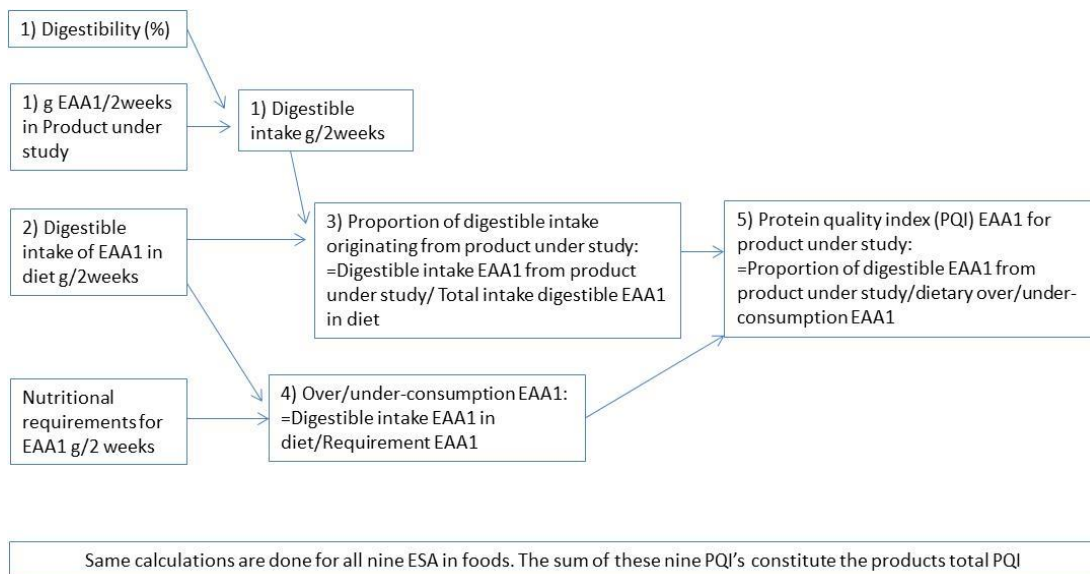

The PQI for a range of products in one dietary context (average Swedish consumption in 2011) was quantified. To exemplify the value of introducing the PQI we applied it on some available LCA studies from previous projects. The products' PQI is used as a complementary FU to capture the nutritional value in the LCA.

### 4. Results

In Figure 2, carbon footprints for six products using the three FU, “kg product”, “g protein” and “PQI” are presented as relative values with bread as the reference.

Figure 2: LCA results for selected products using three functional units, “kg product”, “g protein” and “PQI” for the average Swedish diet. Relative values, Bread=1

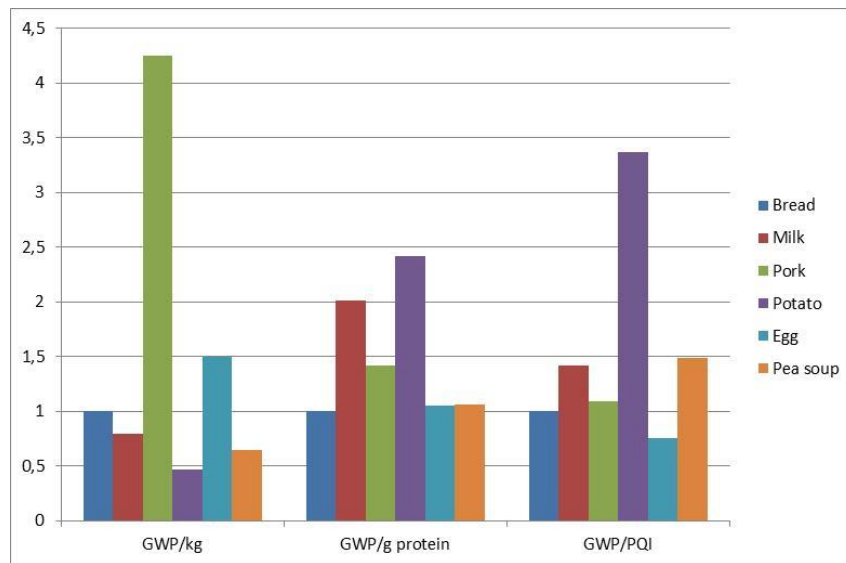

Products with high protein content per kg, such as pork and eggs, have lower impact per kg protein than per kg product, whereas low protein products such as potato and pea soup have higher impact. Milk is a high protein product in one sense, but the water content is also high, hence the increased impact when the FU is g protein. When the protein quality is included (PQI as FU), products with more nutritionally valuable proteins such as pork, eggs and milk, display lower impacts per FU, whereas the reverse is true for vegetable products.

## 5. Discussion

The methodology developed improves the understanding of nutritional aspects in an LCA context. By introducing PQI as an additional FU the Global Warming Potential (GWP) comparison between food products is affected in that the products with “poor” amino acid profiles performs worse when PQI is the FU compared to g protein. The results presented indicate that vegetable protein sources are overrated compared to animal products if g protein is used as FU. It can be noted that pea soup has higher GWP/PQI than all animal products studied.

A general observation is that the complexity in capturing the nutritional function of a single food product is high. The high number of nutrients and the fact that the dietary context needs to be considered are the main complexities, but it can be managed by the proposed method.

We have tested the approach for one dietary context. Obviously, assessments of the method for other dietary contexts are necessary. This will be done later in the project.

Protein deficiency is rarely an issue in western affluent diets so it can be argued that this is not an important issue. Despite that, we still consider it relevant since in the discussions on reducing the intake of animal products, the risk of deficiency for single amino acids increases. If the dietary context is protein-poor, the approach is probably more relevant.

The data needed to apply the method are mostly available. Protein content and amino acid profiles are available for most foods in the literature and in databases. However, data on EAA specific true ileal human digestibility are lacking for many foods, especially for those of animal origin. Getting data for different diets might also be problematic, but national statistics of food consumption from the Food and Agriculture Organization may serve as a useful source.

The method developed uses protein content and -digestibility of EAA as a measure of nutritional value. However, a single nutrient approach is insufficient when discussing sustainable diets, and more research is needed to capture the full complexity of how to eat more sustainably both from a nutritional and environmental perspective.

## 6. Conclusions

The method developed is useful for adding one important aspect of nutrition (protein supply) to LCA results of single products, and the dietary context is critical when the nutritional function of foods is quantified. The results bring new insights for the discussion on sustainable food consumption. The approach can also be used for combinations of nutrients.

### Further research:

- Apply and evaluate the methodology in other dietary contexts, *e.g.* how sensitive the results are for varying dietary contexts, and analyse possibilities for simplification,
- Assess the possibilities for developing a “nutrient density index” including dietary context.

## 7. References

- [1] Tilman, D and Clark, M., 'Global diets link environmental sustainability and human health', *Nature* 515 (2014) 518-522.
- [2] Rööf, E., Karlsson, H., Withöft, C. and Sundberg, C., 'Evaluating the sustainability of diets – combining environmental and nutritional aspects', *Environmental Science and policy* 47 (2015) 157-166.
- [3] Stehfest, E., 'Food choices for health and planet', *Nature* 515 (2014) 501-502.
- [4] Drenowski, A., Rehm, C D., Martin, A., Verger, E O., Voinnesson, M. and Imbert, P., 'Energy and nutrient density of foods in relation to their carbon footprint', *Am. J. Clin. Nutr.* 101 (2015) 184-191.
- [5] USDA (2014) USDA Nutritional Database for Standard Reference Release 27. United States Department of Agriculture, Agricultural Research Service.
- [6] FAO (2012) Report of a sub-committee of the 2011 FAO consultation on "protein quality evaluation in human nutrition" on: The assessment of amino acid digestibility in foods for humans and including a collation of published ileal amino acid digestibility data for human foods, Appendix 1: True ileal amino acid and protein digestibility (%) for selected human foods. Food and Agriculture Organization of the United Nations, Rome, Italy.

# **LCA as a decision support tool in policy making: the case study of Danish spring barley production in a changed climate**

Monia, Niero<sup>1,2</sup> Cathrine H. Ingvordsen<sup>2</sup>, Michael Z. Hauschild<sup>1</sup>, Rikke B. Jørgensen<sup>2</sup>

<sup>1</sup>QSA Division, Department of Management Engineering, Technical University of Denmark,  
Produktionstorvet 424, 2800 Kgs. Lyngby (Denmark)

<sup>2</sup>ECO section, Department of Chemical and Biochemical Engineering, Technical University of Denmark,  
Frederiksborgvej 399, 4000 Roskilde (Denmark)

E-mail contact: [monni@dtu.dk](mailto:monni@dtu.dk)

## **1. Abstract**

*Life Cycle Assessment (LCA) can support policy makers in the choice of the most effective measures to adapt to climate change in crop production. A case study involving spring barley cultivation in Denmark under changed climate conditions has been performed using primary data from future climate scenarios. We developed and applied a 3-step procedure based on combined contribution, scenario and uncertainty analyses. This approach can be useful to deal with uncertainty in scenario analysis for LCA of crop production in a changed climate, when the goal of the study is to suggest strategies for adaptation of crop cultivation practices towards low environmental impacts.*

## **2. Introduction**

Climate change (CC) affects agricultural systems both in terms of crop productivity and environmental sustainability. Environmental sustainability can holistically be evaluated through Life Cycle Assessment (LCA). The use of LCA to assess and compare current crop production and management alternatives is growing, and some guidance on how to tailor LCA for cereal systems has recently been published [1]. The main implications of CC on crop production, and the associated parameters to include when modelling the CC effects on crop production through LCA are: crop yield, crop quality, crop diseases, weeds and pests, incidence of extreme events, N leaching, pesticide leaching, and soil contents of organic carbon [2]. Considering that the lack of primary data is one of the most important drawbacks affecting the reliability of LCA studies, there is a need to use measured data from the system studied for future predictions. This is rarely possible when addressing the impacts of future climate changes, but this study shows how LCA can also effectively predict changes in a broad range of environmental impacts of production systems as a result of the changed climate.

In the context of the NordForsk project “Sustainable primary production in a changing climate”, one objective was to perform a LCA modelling of the environmental impact of spring barley production in Denmark in the second half of this century in the climate forecasted by IPCC 2007 for an unchanged emission of greenhouse gasses. Furthermore, alternative future scenarios were compared, both excluding and including adaptation measures, to provide policy makers with suggestions for where to focus when controlling the potential environmental impacts of future spring barley cultivation.

### 3. Methodology

The main input data for the LCA originate from experiments where spring barley cultivars were cultivated in a climate phytotron under controlled and manipulated treatments mimicking a worst case climate change, i.e. double CO<sub>2</sub> concentration (700 ppm) and a global mean temperature increase of 5 °C in the atmosphere [3]. We followed the 3 step procedure illustrated in Figure 1: (1) definition of a baseline scenario at the Life Cycle Inventory (LCI) level for the current spring barley cultivation in Denmark and performance of Life Cycle Impact Assessment (LCIA) including normalization and contribution analysis, to identify the focus points in terms of impact categories, unit processes and substances; (2) identification of the main deviations from the baseline scenario for these key parameters in alternative future scenarios; (3) comparison of these scenarios with quantification of the resulting uncertainties at LCI level.

Figure 1: Representation of the 3-step procedure for developing LCI of future crop production considering climate change effects, as reported in [2].

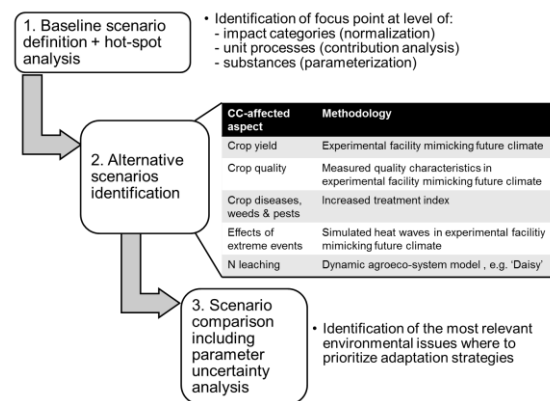

The details of the baseline scenario describing the current cultivation of 1 kg of DM (dry matter) spring barley grain for malting in Denmark are reported in [4]. We also included the effects of CC on crop quality, by performing the analysis on 1 kg CP (Crude Protein) content as functional unit, and the implications of an extreme event (long heat-wave for 10 days with increased day/night temperature). The expected main deviations from the current cultivation were identified in terms of differences in pesticide treatment index (+25%) and modifications in nitrate leaching (+24%), meanwhile the measured change in crop yield ranged from -33.5% to -2.1%, according to different set of cultivars and experimental conditions [4]. This led to the definition of a set of 7 alternative scenarios under future climate conditions [4]:

- no adaptation strategies with full set of cultivars (S1) and best 5 cultivars (S2);
- adaptation strategies as early sowing (S3) or development of improved cultivars with better nutrient efficiency/uptake, and same crop yield as today (S4) or even better (S5);
- extreme event (heat wave) scenarios, with full set of cultivars (S6) and best 5 cultivars (S7).

#### 4. Results and discussion

The LCA results showed an increase of the potential environmental impacts for all future scenarios (S1, S2, S3, S4, S6, S7) of spring barley cultivation in Denmark, when compared to the baseline scenario, except one ideal scenario where yield is not limited by environment or management, i.e. S5 [4]. This trend is confirmed also by the sensitivity analysis which assumes 1 kg CP as functional unit [4], even though the variation among the different scenarios is slightly reduced. Figure 2 shows the LCIA results per 1 kg DM grain obtained applying the abovementioned procedure to the ILCD recommended method [5].

Figure 2: LCA results for the baseline and 7 alternative future scenarios, extracted by [4] by applying the procedure described in [2]

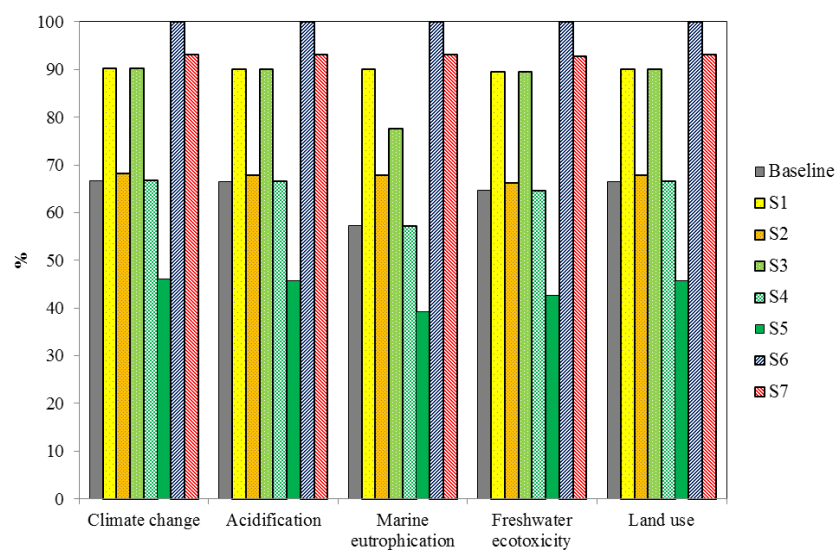

The main driver of the impact is the expected change in crop yield, therefore potential adaptation strategies should mainly focus on influencing this parameter. The selection of resilient and stable cultivars is the most effective way of reducing future environmental impacts of spring barley cultivation in Denmark. These results were confirmed by the uncertainty analysis performed including the variability of input data [2].

The 3-step procedure for managing uncertainty in the definition of future LCA scenarios addressing the effect of climate change in crop production was successfully implemented in the case of spring barley production. It is based on a combination of: contribution analysis to identify the focus points in terms of impact categories, unit processes and substances; scenario analysis to determine a range of alternative future scenarios, as well as the most influencing parameters, and finally uncertainty analysis, to account for different levels of confidence in the output data [2]. Since in the context of CC, decisions are strictly dependent on the response of natural systems to climatic changes, the suggested approach overcomes some of the limitations of the consequential approach, which has mainly been used so far to address LCAs of future scenarios, such as the dependency on economical or technological models [2].



Furthermore, the 3-step procedure is flexible, since it can be applied using different LCIA methodologies [2,4], as well as different approaches to normalization, e.g. the traditional normalization approach based on society's background interventions, or new normalization reference based on the carrying capacity of ecosystems, as recently proposed by Bjørn and Hauschild [5].

## 5. Conclusion

LCA can guide policy makers in the choice of the most effective measures to adapt to climate change in crop production. However, when LCA is used to provide insights on how to pursue future food demand, it has to deal with the uncertainty of future scenarios definition. Our recommendation to reduce that uncertainty is to rely on primary data coming from experiments mimicking the future climate for central system parameters and follow a 3-step procedure based on a combined contribution, sensitivity and uncertainty analysis [2].

## 6. References

- [1] Renzulli, P.A., Bacenetti, J., Graziella, B., Fusi, A., Ioppolo, G., Niero, M., Proto, M., Salomone, R., Sica, D., Supino, S., 2015. Life Cycle Assessment in the Cereal and Derived Products Sector, in: Notarnicola, B., Salomone, R., Petti, L., Renzulli, P.A., Roma, R., Cerrutti, A.K. (Eds.), *Life Cycle Assessment in the Agri-Food Sector. Case Studies, Methodological Issues and Best Practices*. Springer, pp. 185–250.
- [2] Niero, M., Ingvordsen, C.H., Jørgensen, R.B., Hauschild, M.Z., 'How to manage uncertainty in future Life Cycle Assessment (LCA) scenarios addressing the effect of climate change in crop production.' *J of Clean Prod* (2015), doi: 10.1016/j.jclepro.2015.05.061
- [3] Ingvordsen, C.H., Backes, G., Lyngkjær, M.F., Peltonen-Sainio, P., Jensen, J.D., Jalli, M., Jahoor, A., Rasmussen, M., Mikkelsen, T.N., Stockmarr, A., Jørgensen, R.B., 'Significant decrease in yield under future climate conditions: Stability and production of 138 spring barley accessions.' *Eur. J. Agron.* (2015) 63, 105–113.
- [4] Niero, M., Ingvordsen, C.H., Peltonen-Sainio, P., Jalli, M., Lyngkjær, M.F., Hauschild, M.Z., Jørgensen, R.B. 'Eco-efficient production of spring barley in a changed climate: A Life Cycle Assessment including primary data from future climate scenarios.' *Agric. Syst.* 136 (2015) 46–60.
- [5] Hauschild, M.Z., Goedkoop, M., Guinée, J., Heijungs, R., Huijbregts, M., Jolliet, O., Margni, M., De Schryver, A., Humbert, S., Laurent, A., Sala, S., Pant, R., 'Identifying best existing practice for characterization modeling in life cycle impact assessment' *Int J Life Cycle Assess* 18 (2013)683–697.
- [6] Bjørn, A., Hauschild, M.Z. 'Introducing carrying capacity-based normalisation in LCA: framework and development of references at midpoint level.' *Int. J. Life Cycle Assess.* 20 (2015) 1005-1018.

## **Mediterranean countries' food supply and food sourcing profiles: An Ecological Footprint viewpoint**

Alessandro Galli<sup>1</sup>; Nicole Grunewald<sup>1</sup>; Katsunori Iha<sup>1</sup>; Martin Halle<sup>1</sup>; Derek Eaton<sup>1</sup>;  
Roberto Capone<sup>2</sup>; Hamid El Bilali<sup>2</sup>

<sup>1</sup>Global Footprint Network, 7-9 Chemin de Balexert, 1219 Geneva, Switzerland

<sup>2</sup>International Centre for Advanced Mediterranean Agronomic Studies in Bari (CIHEAM-Bari),  
Via Ceglie 9, 70010 Valenzano (Bari), Italy

*E-mail contact:* [alessandro.galli@footprintnetwork.org](mailto:alessandro.galli@footprintnetwork.org)

### **1. Abstract**

*Securing food for growing populations is becoming a key topic in the current sustainability debate. The aim of this paper is to examine food supply and food sourcing profiles for 15 Mediterranean countries for which data is available, through Ecological-Footprint-Extended Multi-Regional Input-Output (EF-MRIO) analysis.*

### **2. Introduction**

Food provision is one of the vital services that nature provides to humanity, from both a biological (*i.e.* feeding individuals) and cultural (*e.g.* social relations) viewpoint [1,2]. However, food's role in the social and cultural life of Mediterranean people is shifting due to globalisation and behavioural changes [3]. The food we choose, its production and distribution chains, and the way in which we eat have multifaceted effects on our environment, society and economy. This places food at the heart of the sustainability debate and issues such as food availability and supply, accessibility and sourcing, stability of supply and affordability are particularly salient in the Mediterranean region. Moreover, food demand noticeably contributes to the wider regional demand for the biosphere's ecological assets [4].

The aim of this paper is: i) to investigate human pressure on ecosystems due to current food production, trade and final consumption patterns of fifteen Mediterranean countries through the use the Ecological Footprint approach; and ii) to examine implications for food security – the capacity to guarantee access to food resources through both domestic production and trade – and food self-sufficiency – the capacity to guarantee access to food resources from domestic production.

### **3. Methodology**

Here we extend the Multi-Regional Input-Output (MRIO) model provided by the Global Trade Analysis Project with Ecological Footprint Accounting – in what we define as Ecological-Footprint-Extended Multi-Regional Input-Output analysis (EF-MRIO) – to estimate countries' availability of, and demand for, food resources. This model provides a macro-level, top-down Life Cycle Analysis (LCA) of the requirements for renewable natural resource production and carbon sequestration capacity along the entire food supply chain of the selected countries.

Ecological Footprint Accounting [5] tracks demand for biologically productive land and marine areas to produce the natural resources and ecological services that humans consume (aggregated into a metric called *Ecological Footprint*) and compares it with the biosphere's supply of such resources and services (aggregated into a metric called *biocapacity*).

Full details on the calculation of the two metrics as well as their limitations can be found in Borucke *et al.* [6]. Both metrics are expressed in global hectares (gha), which represent productivity-weighted hectares [6].

For the purpose of this paper the entire biocapacity provided by cropland, grazing land and fishing grounds is considered to be put to food production and thus added together to derive countries' food-related biocapacity ( $fBC$ ). Conversely, the total Ecological Footprint embedded in countries' final demand for food products (namely food Ecological Footprint -  $fEF$ ) is calculated via EF-MRIO: the traditional National Footprint Accounts methodology (as described in [5]) is used to calculate the Ecological Footprint of production activities while the  $fEF$  for country N is derived according to equation 1 (see also [7,8]):

$$fEF_N = F(I-A)^{-1}y_N \quad (1)$$

where  $F$  is the environmental extension matrix derived from the Ecological Footprint of production, for each commodity  $y_N$ ;  $I$  is the identity matrix (a  $57 \times 57$  square matrix of zeros with diagonal consisting of ones) and  $A$  is the technical coefficients matrix, which reflects the monetary exchange between each sector in order to produce one currency unit worth of output from a specific sector of the economy. Thus equation 1 accounts for all indirect/upstream resource requirements from final consumption [8].

The EF-MRIO model calculates the resource requirements of each sector in the economy; household food resource requirements are then calculated by analyzing the composition of household final demand for goods and services by consumption category (e.g., cereals, dairy or meat). Food consumption Footprints are compared with food biocapacities to get a macro-level insight on each country's food supply, consumption and food sourcing profiles.

#### 4. Results

The  $fEF$  of consumption varies among Mediterranean countries, mainly due to different dietary habits. Protein-intensive diets are found in the countries with the higher  $fEF$  [9].  $fBC$  varies as well, with France having by far the highest per capita  $fBC$  among Mediterranean countries with 1.85 gha per capita per annum (Figure 1).

Figure 1: Per capita  $fEF$  and  $fBC$  for 15 selected Mediterranean countries and the region average (Med15), in 2010. Results are expressed in global hectares (gha)

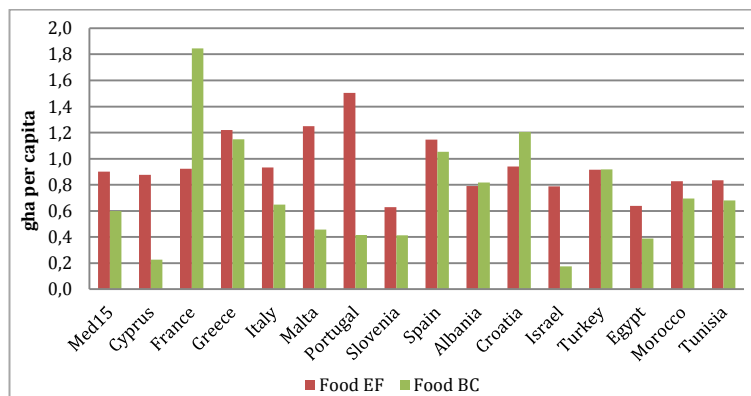

France has the biggest share of the region's  $\rho$ BC trade flows (27% or  $\approx$ 80 million gha), followed by Spain (21%,  $\approx$ 82 million gha), Italy (19%,  $\approx$ 56 million gha), Egypt (8% or  $\approx$ 24 million gha) and Turkey (7% or  $\approx$ 21 million gha). Moreover, all countries in the Mediterranean region – except France – are net importers of food biomass to satisfy the food consumption needs of their residents (Figure 2).

Cereals represent the largest share of net  $\rho$ BC trade in all 15 countries (Figure 2), and all countries, except France, are net importers. Italy is the largest net importer of  $\rho$ BC for the consumption of all food types, primarily importing from France (wheat and livestock – such as cattle, sheep and goats, horses), China (livestock and vegetables, fruit, nuts) and Brazil (livestock and cereals). Conversely, France exports mainly cereal-related  $\rho$ BC (*i.e.*, wheat, other cereal grains and oil seeds) to Italy, Germany and Spain and imports  $\rho$ BC embodied in fish (from Norway, USA and China), livestock (from China, Brazil and New Zealand) and vegetables, fruit and nuts (from Spain, China and Madagascar).

Figure 2:  $\rho$ EF embedded in net trade, by type of food, for 15 selected Mediterranean countries and the region average (Med15), in 2010. Results are expressed in global hectares (gha).

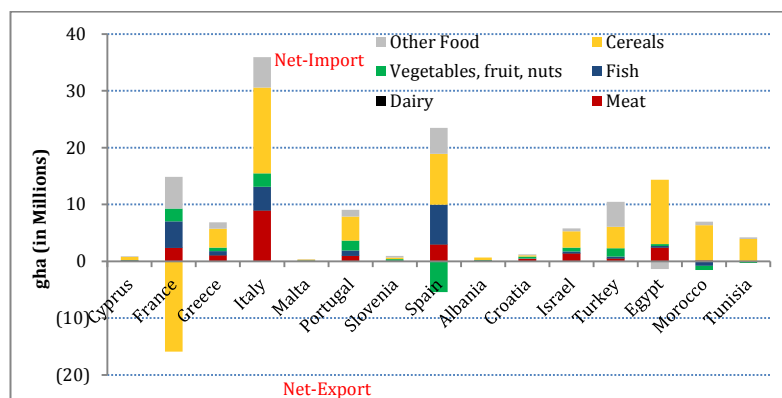

## 5. Conclusion

Our analysis showed that, with a few exceptions, Mediterranean countries currently rely on  $\rho$ BC imports (mostly of biomass for cereal consumption) to meet the food consumption demand of their residents.

France was found to have the highest per capita  $\rho$ BC in the region, and to represent the main trade partner for most of the other countries, although the bigger share of the Mediterranean  $\rho$ BC trade takes place with partners outside the region, especially with USA, Germany and China. A growing world population and climate change are likely to lead to decreasing per capita food availability across the planet, potentially affecting countries' food security and food system sustainability. Sourcing food products through imports does not represent an economic risk *per se* and we shall not assume that self-sufficiency is always a safer means of sourcing food; “food security-related” risks may exist irrespective of food being sourced locally or abroad. Food self-sufficiency might expose countries to domestic food supply disruption; countries with extreme self-sufficiency policies (e.g., import barriers, export bans, and a complete reliance on domestic production), could be hit by supply disruption harder than countries with diversified food sourcing profiles.

Conversely, dependence on imports can stress a country's macro-economy due to higher prices and increased agricultural market volatility. This, in turn, can arise from market disruptions such as export bans from major wheat producers (e.g., Russia, Ukraine) following supply shocks caused by bad harvests.

This comparative analysis of Mediterranean countries' food supply and food sourcing profiles could help in identifying behavioral and policy interventions that can limit the impact of scarcities and support sustainable consumption patterns and diets.

## 6. References

- [1] Fischler C., 'Food, self and identity', *Soc Sci Info* 19, (1988) 937–953.
- [2] Nordström, K., et al., 'Food and health: individual, cultural, or scientific matters?' *Genes Nutr* 8(4), (2013) 357–363.
- [3] Kickbusch, I., 'Triggering the debate – white paper: The food system' (Promotion Santé Suisse, 2010).
- [4] Galli, A. and Halle, M., 'Mounting Debt in a World in Overshoot: An Analysis of the Link between the Mediterranean Region's Economic and Ecological Crises', *Resources* 3, (2014) 383–394.
- [5] Wackernagel, M. and Rees, W., 'Our Ecological Footprint: Reducing Human Impact on the Earth' (New Society Publishers, 1996).
- [6] Borucke, M. et al., 'Accounting for demand and supply of the biosphere's regenerative capacity: The National Footprint Accounts' underlying methodology and framework', *Ecol. Indic.* 24, (2013) 518–533.
- [7] Ewing, B.R. et al. 'Integrating ecological and water footprint accounting in a multi-regional input–output framework', *Ecol. Indic.* 23, (2012) 1–8.
- [8] Weinzettel, J., et al., 'Ecological footprint of nations: Comparison of process analysis, and standard and hybrid multiregional input–output analysis', *Ecol. Econ.* 101, (2014) 115–126.
- [9] Grunewald, N., et al., 'The Ecological Footprint of Mediterranean Diets' *CIHEAM Watch Letter* 32, (2015) 10–16.

# Simplified modelling of environmental impacts of foods

Franck Pernellet, Carla Coelho, Hayo M G van der Werf

Inra, Agrocampus Ouest, UMR 1069, Sol Agro et hydro Système, 35000 Rennes Cedex, France

E-mail contact: [Hayo.vanderwerf@rennes.inra.fr](mailto:Hayo.vanderwerf@rennes.inra.fr)

## 1. Abstract

*Human nutrition strongly contributes to several environmental impacts, resulting in more and more LCA studies on foods and diets. As a result of lack of data, simplifications are often made regarding the foods considered, the system boundaries and the impact categories. This study compared three simplified LCA methods to a full cradle to retailer LCA and a full cradle to mouth LCA, to identify ways to simplify impact assessment of food and diets. These methods were applied to three diets (Average French, Healthy and Vegetarian), comprising 105 foods. The proposed simplified methods can offer better approximation of impacts of diets than a full cradle to retailer LCA. When comparing impacts of the Average, Healthy and Vegetarian diets, all simplified methods were biased. Results obtained by the most comprehensive simplified method were, for most of the impacts studied, closest to those of a full cradle to mouth LCA. These methods should be tested on more diet types and for more impacts for validation.*

## 2. Introduction

The food sector has been identified to be a significant contributor to several environmental impacts, such as climate change [1] and land occupation [2]. Due to a lack of data on food products, life cycle assessment (LCA) studies on diets often make simplifications. Common simplifications are the reduction of the number of foods considered using a proxy to model a group of foods [3], modelling only up to farm gate [4, 5] or to retailer [6] instead of the full life cycle, or considering only greenhouse gases [1, 4]. These simplifications can strongly affect the results. This study proposes three methods to simplify LCA of food products, considering time available and required robustness of results.

## 3. Methods

The simplified methods analysed are listed hereafter; they were compared to a) a full cradle to retailer LCA (Fc-r) and b) a full cradle to mouth LCA (Fc-m).

- Scaled farm (S): Calculates impacts from cradle to farm multiplied by the kg of product at the farm gate necessary to obtain one kg of ingested product (based on waste at industry, retailer and home, and the cooking weight-change due to rehydration or dehydration during cooking), plus impacts of waste treatment. Data up to farm gate are often available or can be estimated relatively easily. The use of this method can be justified by the assumption that for a food product, most of the impact is often due to the farm stage.
- Scaled farm and cooking (Sc): this method improves the S method by adding cooking impacts which consider the type of technology as well as cooking time.
- Scaled farm, cooking and transport (Sc-t): this method improves the Sc method by adding transport impacts. The transport included are: from farm to industry, from industry to retailer and from retailer to consumer home.

The environmental impacts are calculated for a 15-day meal plan. The menus which excluded alcoholic beverages, were developed by nutritionists based on the 105 most consumed food items in a French survey [7]. Three diets were created: “Average”, “Healthy” and “Vegetarian”. The Average diet was adapted from survey data to approximate the actual food consumption of an adult French male. Compared to the survey data, the Average diet supplied the same energy and macronutrients, but included only the foods most consumed, for simplification. The Healthy diet resulted from modifying the Average diet to adhere to French nutritional recommendations [8]. For the Healthy diet the quantity of fruits, vegetables, starchy foods and dairy products increased, and the quantity of meat and pastries decreased. The Healthy diet was modified to obtain a “healthy vegetarian diet” (hereafter called “Vegetarian diet”): fish and meat were replaced by eggs, pulses, vegetables, tofu and mung bean sprouts.

### Results

The three simplified methods were applied to assess the three diets. The impacts investigated were: climate change, cumulative energy demand (CED), acidification, eutrophication and land occupation. Compared to the detailed cradle to mouth LCA ( $F_{c-m}$ ), the underestimations (in %) for the average diet with the S and Sc-t methods were respectively (23, 60, 10, 8, 5) and (11, 30, 4, 5, 5) for climate change, cumulative energy demand, acidification, eutrophication and land occupation (Figure 1)

Selected results for the comparison of the five methods and the three diets for Climate Change are presented in figure 2. When comparing diets for this impact category,  $F_{c-r}$  and Sc-t performed best; their estimate of the difference between the Average and Vegetarian diets was within 5 percentage points of the estimate by  $F_{c-m}$ , the reference method. For absolute numbers Sc-t was closest to  $F_{c-m}$  for all diets.

Figure 1: Relative values of the impacts climate change (CC), cumulative energy demand (CED), acidification (AC), eutrophication (EU) and land occupation (LO) for the Average diet according to five calculation methods. ( $F_{c-m}$ : full cradle-to-mouth method; S: scaled farm-impact method;  $S_c$ : scaled farm-impact and cooking method;  $S_{c-t}$ : scaled farm-impact, cooking and transport method;  $F_{c-r}$ : full cradle-to-retailer method).

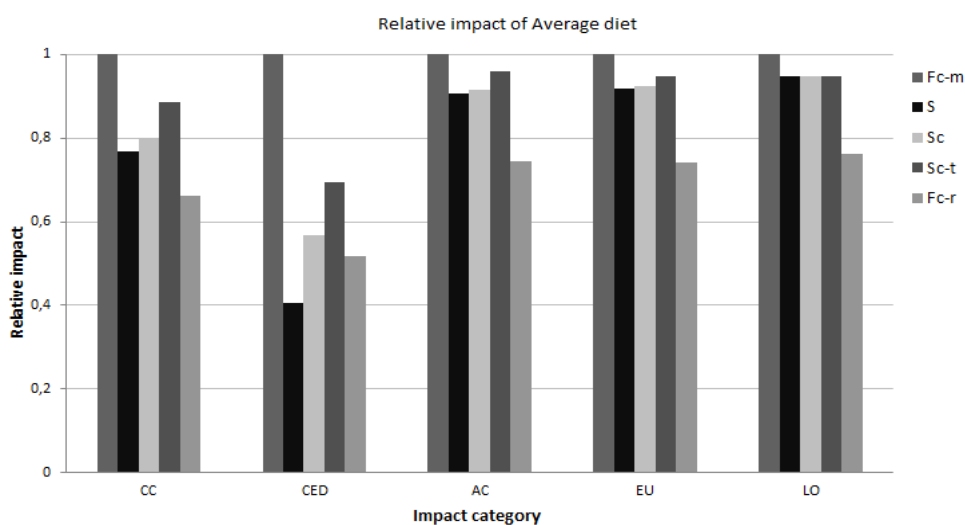
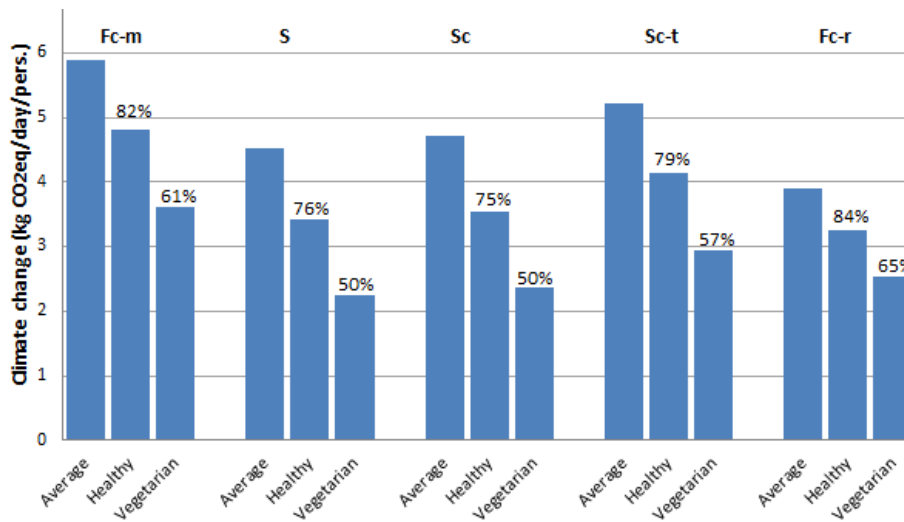

Figure 2: Climate change impact of Average, Healthy and Vegetarian diets according to five calculation methods. Percentages indicate relative impacts of Healthy and Vegetarian diets compared to the Average diet. ( $F_{c-m}$ , full cradle-to-mouth method;  $S$ , scaled farm-impact method;  $S_c$ , scaled farm-impact and cooking method;  $S_{c-t}$ , scaled farm-impact, cooking and transport method;  $F_{c-r}$ , full cradle-to-retailer method)



Time required for implementation was least for method S, followed by Sc, Sc-t, Fc-r, and Fc-m which was most time-demanding. However is important to note that not all methods are suitable for assessing all products. Method S is suitable for products with a high cradle to farm impact such as dairy and meat products (Table 1). Method Sc-t is suitable for fruit, vegetables, pulses, dairy and meat products, but is too imprecise for products with high-impact packaging (can and glass), or for products with a high energy demand during industrial transformation such as coffee, semolina, ultra-high temperature milk.

Table 1: Simplified methods considered suitable for impact assessment according to food category and impact category for climate change (CC), cumulative energy demand (CED), acidification (AC), eutrophication (EU) and land occupation (LO). ( $F_{c-m}$ , full cradle-to-mouth method;  $S$ , scaled farm-impact method;  $S_c$ , scaled farm-impact and cooking method;  $S_{c-t}$ , scaled farm-impact, cooking and transport method;  $F_{c-r}$ , full cradle-to-retailer method)

Food Category	CC				CED				AC				EU				LO			
	Sc-t	Sc	S	Fc-r	Sc-t	Sc	S	Fc-r	Sc-t	Sc	S	Fc-r	Sc-t	Sc	S	Fc-r	Sc-t	Sc	S	Fc-r
Meat	x	x	x						x	x	x		x	x	x		x	x	x	
Homemade meat-based dish	x	x							x	x	x		x	x	x		x	x	x	x
Dairy and egg	x	x	x	x					x	x	x	x	x	x	x	x	x	x	x	x
Cooked vegetable and potato	x				x				x				x	x						
Raw vegetable	x				x				x				x	x	x					
Fruit	x				x				x				x							
Fish	x	x	x		x				x	x	x									
Wheat-based and rice product	x								x	x	x		x	x	x		x	x	x	
Sugar-based product	x			x				x				x				x				x
Homemade vegetarian dish	x				x				x				x	x			x	x	x	
Homemade dessert	x								x	x	x		x	x	x		x	x	x	x
Oil	x								x	x	x	x	x	x	x	x	x	x	x	x
Pulse	x				x				x				x	x			x	x	x	



## Conclusion

The proposed methods can offer better approximation of impacts of diets than simplified methods considering only impacts from cradle to retailer door. When comparing the three diets, all methods showed highest impacts for the Average diet and lowest impacts for the Vegetarian. Absolute values obtained by method Sc-t were closest to those of a full cradle to mouth LCA. These methods should be tested on more diet types and for more impacts for validation.

## 7. References

- [1] Vieux, F., et al., High nutritional quality is not associated with low greenhouse gas emissions in self-selected diets of French adults. *Am J Clin Nutr*, 2013. 97(3): p. 569-83.
- [2] Meier, T. and O. Christen, Environmental Impacts of Dietary Recommendations and Dietary Styles: Germany As an Example. *Environmental Science & Technology*, 2013. 47(2): p. 877-888.
- [3] Munoz, I., L.M.I. Canals, and A.R. Fernandez-Alba, Life cycle assessment of the average Spanish diet including human excretion. *International Journal of Life Cycle Assessment*, 2010. 15(8): p. 794-805.
- [4] Tilman, D. and M. Clark, Global diets link environmental sustainability and human health. *Nature*, 2014. 515(7528): p. 518-22.
- [5] Fazeni, K. and H. Steinmüller, Impact of changes in diet on the availability of land, energy demand, and greenhouse gas emissions of agriculture. *Energy, Sustainability and Society*, 2011. 1(1): p. 6.
- [6] Vieux, F., et al., Greenhouse gas emissions of self-selected individual diets in France: Changing the diet structure or consuming less? *Ecological Economics*, 2012. 75: p. 91-101.
- [7] CREDOC, Comportements et consommations alimentaires en France- La réponse à vos questions stratégiques et marketing, C. publication, Editor 2010: France. p. 4.
- [8] Delamaire, C., La santé vient en mangeant. *Le guide alimentaire pour tous*, 2011, PNNS: France. p. 130.

# Life Cycle Assessment of Thai Organic Rice to Evaluate the Climate Change, Water Use and Biodiversity Impacts

Author(s): Rattanawan, Mungkung<sup>1,2</sup>, Patthra Pengthamkeerati<sup>1</sup>, Ratcha Chaichana<sup>1</sup>, Saranya Watcharothai<sup>3</sup>, Kittiwat Kitpakornsanti<sup>2</sup>, and Supachok Tapananont<sup>2</sup>

<sup>1</sup>Department of Environmental Technology and Management, Faculty of Environment, Kasetsart University, 50 Ngamwongwan Road, Chatuchak, Bangkok 10900, Thailand

<sup>2</sup>Centre of Excellence on enVironmental strategy for GREEN business (VGREEN), Faculty of Environment, Faculty of Environment, Kasetsart University, 50 Ngamwongwan Road, Chatuchak, Bangkok 10900, Thailand

<sup>3</sup>Department of Botany, Faculty of Science, Kasetsart University, 50 Ngamwongwan Road, Chatuchak, Bangkok 10900, Thailand

E-mail contact: fscirwm@ku.ac.th

## 1. Abstract

*LCA of Hom Mali organic rice production was performed in Surin, Thailand. The results revealed that the impact on climate change was 3.69 kgCO<sub>2</sub>e per kg of paddy rice, however using the emission factor from primary data could yield 26% higher than using the default emission factor defined in the Product Category Rules due to higher emissions and lower yield. But, this could not be generalized for other farming sites due to geographical variations in rice production. The calculation of impact on water use with consideration of the water stress index of Mun watershed was 0.15 m<sup>3</sup>H<sub>2</sub>Oe. However, this figure does not reflect the consumptive water volume as it was required for higher productivity and pest control but was not removed from the watershed. The biodiversity impact assessment based on the SALCA-Biodiversity was found to be practical but largely dependent on the expertise and experience of the assessors.*

## 2. Introduction

Organic rice farming is seen as an alternative system for more sustainable rice production due to lower risks from chemical use, increasing biodiversity, lower production costs, and higher price. At present, the proportion of organic rice is only 0.18% (19,994 ha) of the total area of rice production in Thailand. However, it is targeted to be increased to 10% in 2016 as stated in the national strategic plan of organic agricultural production to become the regional hub for organic agricultural products [1]. Also, the environmental product declaration of agri-food products is likely to be in demand in the near future for international trading [2].

## 3. Methodology

### 3.1 Goal and scope

The LCA study of organic rice production in Surin in the Northeast, which is the main production site of Thailand, was performed to evaluate the potential environmental impacts. The scope of study was the farm's gate and the functional unit was set as 1 kg of organic paddy rice. The results of LCA could be used to anticipate the environmental product declaration to support the market requirements.

### 3.2 Inventory analysis

The study site was a paddy field of "Hom Mali" organic rice. The rice farming system was in-season rice based on broadcasting and rain-fed. Based on the production cycle in 2013, the inputs and outputs of rice farming system were collected from the primary data, including the direct measurement of water levels

inside the rice field over the production cycle (190 days). The amounts of methane and nitrous oxide emitted from the organic rice field were directly measured. Background data, such as production of electricity and agrochemical, were mainly sourced from the Thai national life cycle inventory databases and supplemented with international databases when necessary.

### 3.3 Impact assessment

The impact categories of interest are: Climate change, Water use, Eutrophication, Terrestrial and Freshwater eco-toxicity, including Biodiversity. The impact assessment methodology is ReciPe Version 1.08 (2008) for Climate change, Water use, Eutrophication, Terrestrial and Freshwater eco-toxicity. The Swiss Agricultural Life Cycle Assessment Biodiversity or SALCA-Biodiversity [3] was used to assess the Biodiversity impact to explore its potential application in the local context. Especially for the biodiversity impact assessment, it was compared with a non-organic rice field to see the differences.

### 3.4 Interpretation

The LCA results were used to identify the practical issues associated with the environmental product declaration to anticipate the market trend of agri-food products on climate change, water use and biodiversity impacts.

## 4. Results

The inventory data analysis results showed that the organic rice farming required 0.01 L of diesel, 3.59 kg of organic fertilizer, 4.94 m<sup>3</sup> of rain water; the direct emissions of methane was 0.16 kg per kg of paddy rice and that of nitrous oxide from organic rice farming was 0.0001 g per kg of paddy rice. The LCA results are shown in Table 1.

*Table 1: LCA results of the Hom Mali organic rice farming in Surin, the Northeast of Thailand*

Impact categories (Unit)	Value
Climate change (kgCO <sub>2</sub> e)	3.69
Water use (m <sup>3</sup> H <sub>2</sub> Oe)	0.15
Eutrophication (kgPO <sub>4</sub> <sup>3-</sup> e)	0.01
Terrestrial eco-txocity (kg 1,4-DBe)	4.54E-07
Freshwater eco-toxicity (kg 1,4-DBe)	1.04E-05

Referring to the Product Category Rules (PCRs) of rice products, the default emission factor of methane from rain-fed organic rice fields in the Northest was 304 kg/ha/production cycle, which is equivalent to 0.14 kg per kg of paddy organic rice; this was based on the assumption that the organic fertilizer was used at 625 kg per ha and the yield was 2,188 kg per ha [4]. In this study, the methane from direct measurement was 422 kg/ha/production cycle, whereas that from the organic rice field in Khon Kaen was 363 kg/ha/production cycle [5]. In terms of nitrous oxide, the result of direct measurement was 0.21 kg/ha/production cycle whereas the default emission factor was based on the theoretical calculation from the component N of fertilizer according to the IPCC method and yielded at 0.48 kgN<sub>2</sub>O/ha/production.

The sensitivity analysis showed that the climate change impact value by using the emission factor from primary data could yield 26% higher values than that by using the ones from secondary data in the PCRs due to higher emissions and lower yield. However, this could not be generalized for other farming sites due to variations in seed quality, soil type, fertilizer kind and rate of application, as well as farming management practices especially water management and land preparation for the next crop. Therefore, the default emission factors applied in the PCRs of rice product based on the IPCC method, Tier 1 methodology are reasonable in terms of conservative approach as the value is higher.

In terms of water use impact, if it was assumed that the rice field was within the irrigated zone then the calculation of LCA-based water footprint with consideration of the water stress index of Mun watershed as 0.927 [6] would yield 0.15 m<sup>3</sup>H<sub>2</sub>Oe. However, this figure does not reflect the consumptive water volume; a flooded system for rice farming is required for higher productivity and pest control only but it is not actually lost. The water will eventually return back to the same watershed. The impact indicator of water use could be useful for irrigation management rather than displaying on the products for consumers.

The field survey of biotic resources in organic and non-organic rice fields showed that the numbers of species are similar but the density of zooplankton, phytoplankton and benthos are 8, 4 and 3 times higher, respectively, in organic rice. The number of fish and invertebrates with plants in organic rice are almost 2 times higher and almost 10 times higher in terms of density. Thus, the biodiversity impact of organic rice was higher than that of non-organic rice for all indicator species groups (Table 2). However, the biodiversity assessment based on the SALCA-Biodiversity especially the scoring method was largely dependent on the expertise and experience of the assessors.

Table 2: Biodiversity score of organic and non-organic rice farming systems

Organism	Biodiversity score	
	Organic rice	Non-organic rice
Phytoplankton	22.54	18.50
Zooplankton	13.00	11.68
Benthos	12.86	11.81
Invertebrates with plants	12.31	11.45
Fish	13.81	13.27

#### 4. Conclusion

The climate change impact of Hom Mali organic rice was 3.69 kgCO<sub>2</sub>e per kg paddy. The calculation of water use impact with consideration of the water stress index of Mun watershed was 0.15 m<sup>3</sup>H<sub>2</sub>Oe. The biodiversity impact based on the SALCA-Biodiversity were 12.31-22.54, and higher than that of non-organic rice. Environmental label is being encouraged in Thailand to anticipate the market trend, but it must not cause a barrier to trade. The method of displaying on environmental label is a major concern that must be easy to understand by consumers.

## 5. References

- [1] Office of Agricultural Economic, 'Policy of organic agricultural products' (in Thai) (2014).
- [2] Schenck, R., Huizenga, D. (Eds.), 2014. Proceedings of the 9th International Conference on Life Cycle Assessment in the Agri-Food Sector (LCA Food 2014), 8-10 October 2014, San Francisco, USA. ACLCA, Vashon, WA, USA.
- [3] Jeanneret, Ph., Baumgartner, D.U., Knuchel, R.F., and Gaillard, G., 'Integration of biodiversity as impact category for LCA in agriculture (SALCA-Biodiversity)', in 6th International Conference on LCA in the Agri-Food Sector, Zurich, November, 2008.
- [4] Thailand Greenhouse Gas Management (Public Organisation), 'Product Category Rules: Rice Products' (in Thai), (2011) Available at <http://thaicarbonlabel.tgo.or.th/PCR/A4.pdf>
- [5] Sanwangsi, M., Saenjun, P., Seripong S. and Iwayu, C.B., 'Improving Rice Production and Methane Mitigation by Using Chemical and Organic Fertilizers with Appropriate Water Management in Irrigated Rice Field'. J. of Konkaen Uni. (in Thai). 5(2) (2014) 36-46.
- [6] Gheewala, S.H., Silalertruksa, T., Nilsalab, P., Mungkung, R., Perret, S.R., and Chaiyawannakarn, N. 2014. Water Footprint and Impact of Water Consumption for Food, Feed, Fuel Crops Production in Thailand. Water 6(6), 1698-1718.

# Comparative LCA study on environmental impact of oil production from microalgae and terrestrial oilseed crops

D. Spinelli, S. Jez, E. Busi and R. Basosi

Department of Biotechnology, Chemistry and Pharmacy, University of Siena, Italy

E-mail contact: [sabina.jez@unisi.it](mailto:sabina.jez@unisi.it)

## 1. Abstract

Policies for reducing fossil fuel depletion and GHG emissions have improved the development of low carbon sustainable energy. Besides the first generation biofuels that made arise many environmental burdens and the competition between food and no food, algae-to-energy systems show several advantages for bioenergy application compared with conventional crops. On the other side their cultivation requires energy-intensive inputs. Comparative LCA may provide the eco-profiles of microalgal and terrestrial crops oil production chains. Different scenarios were considered: microalgae production using alternative energy sources as biogas obtained from de-oiled cake and renewable technologies (i.e. photovoltaic) and the byproduct (meal) as cattle feed (case of rapeseed and sunflower).

## 2. Introduction

Numerous studies have been conducted on various biomass feedstocks such as rapeseed, soybean, canola, corn and lignocellulosic crops for their application as bioenergy source. With regard to first generation biofuels, the use of resources from agricultural sector induces a lower climate change potential, but on the other hand can create other environmental burdens and increase the competition with food. Major drawbacks to these, first and second generation biofuels have prompted research in alternative forms of biomass. Microalgae shows several advantages for bioenergy application compared with conventional crops, such as: high productivity, ability to be cultivated on marginal lands and therefore may not incur land-use change, semi-continuous to continuous harvesting, high lipid content, potential to utilize carbon dioxide (CO<sub>2</sub>) from industrial flue gas and nutrients from wastewater [1]. The recent microalgae based life cycle assessments (LCA) studies show that different algae harvesting options, reactor configurations, culture conditions, and cultivation assumptions yield give divergent results concerning algae's environmental and energy performance[2,3]. Anyway algae show higher environmental impacts than terrestrial crops in almost all the categories considered [4]. Mainly responsible of these results are the high power consumption and nutrients demand. The purpose of this study is to compare through an LCA study the environmental performance of oil from rapeseed and sunflower cultivated in Campania and from microalgae (*Scenedesmus obliquus*) with the use of conventional and alternative energy sources.

## 3. Material and methods

### 3.1 Vegetable oil system boundary

The LCA was performed using the ReCiPe method [5] and the software SimaPro 7.3. Data for agricultural production of the energetic crops are primary and provided by experimental plots located in Campania. Rapeseed and sunflower were grown using traditional farm practices. The same amount of N and K fertilizer

was provided to both crops. The cultivation of sunflower has required 100% more phosphorous and 52% more fossil fuel than rapeseed and a rescue irrigation of 280 m<sup>3</sup>ha<sup>-1</sup>. The N<sub>2</sub>O emissions were calculated by applying an experimental emission factor (EF) of 0,8 [6]. The data for industrial oil extraction and refining were found in the literature [7-8]. The Functional Unit (F.U.) is 1 kg of refined oil.

In Figure 1 the scheme of the process and system boundaries are reported.

Figure 1: System boundaries overview for oilseed crops

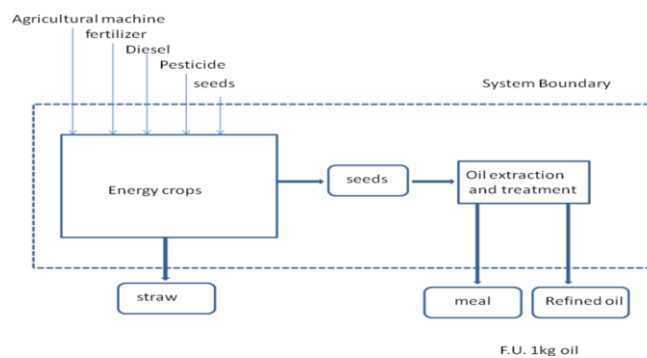

### 3.2 Microalgae biorefinery system boundary

The algal strain *Scenedesmus Obliquus* cultivated in ponds with the use of livestock wastewater as nutrient source has been selected as “best case” on the basis of previous LCA studies [9-10].

In Figure 2 the scheme of the process and system boundaries are reported. Data from literature were used to determine the microalgal oil recovery system by solvent extraction and the recovery system by a stripper column for separation of microalgal oil/hexane stream [11]. Electricity production is based on the European energetic mix, in which heat is produced with natural gas burned in industrial gas boilers.

For the different scenarios data from literature have been used: 1) microalgal cake for biogas production [12], 2) green energy from microalgae: usage of algae biomass for anaerobic digestion [13]. Moreover: biogas content has been estimated 65% [13], biogas purification is achieved by bubbling it into pressurized water. Use of renewable energy as photovoltaic technology has been also investigated using data from SimaPro 7.3.3 Ecoinvent 2.2 database.

Figure 2: System boundaries overview for microalgal oil production

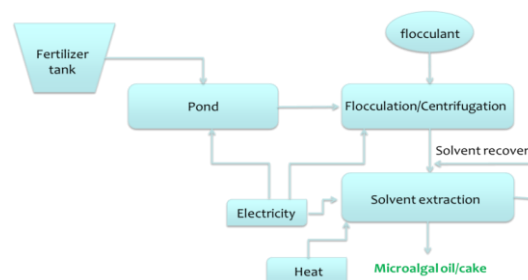

## 4. Results and discussion

### 4.1 Comparison of oil from terrestrial crops and oil from algae

The feedstock cultivation represents the heaviest environmental burdens in the oil production chain. From the comparison between rapeseed and sunflower, rapeseed results as the oil crops with the low environmental impact in all categories considered when an economic allocation is applied.

As reported in Figure 3, microalgal oil production process has much higher environmental impacts compared with sunflower oil and rapeseed oil. The large impacts are due to the heavy energy demand (electricity and heat) and material consumption for the algae biomass production. The cultivation stage has the largest electricity requirement for air and nutrient pumping into raceway pond, water pumping due to evaporation lost and pumping algae slurry for harvesting stage. The total process contributions to environmental impact categories are the following: microalgae cultivation (56.4%), biomass harvest (4.5%) and oil extraction (39.1%). Regarding the energy demand of whole process for microalgal oil production, two scenarios have been evaluated: (A) use of microalgal cake for biogas production and (B) use of photovoltaic technology. Each scenario shows reduced environmental impact respect to the base case. Scenario A shows higher impacts respect to Scenario B because of electricity and heat demand for microalgal cake anaerobic digestion and biogas purification step. A decrease of about 35% in Climate change and 15% in Fossil depletion occur when photovoltaic energy is used in spite of electricity European mix.

Figure 3: Comparison between sunflower oil, rapeseed oil and microalgal oil production processes.

Method: ReCiPe Midpoint (H) V1.04 / Europe ReCiPe H / Characterization

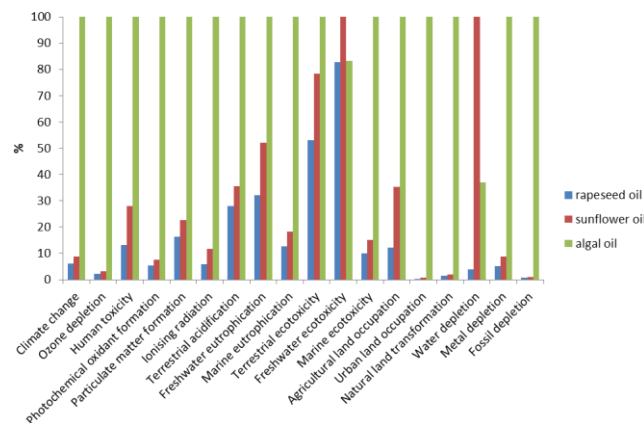

A comparison between sunflower, rapeseed and microalgae as feedstock for oil production is reported in Figure 3. Use of renewable technologies as photovoltaic could increase the competitiveness of microalgal oil production chain reducing its demand of non-renewable energy sources (Figure 4). Another aspect is the possibility to increase the lipid content of microalgal species using different nutrients composition (i.e. wastewaters with low nitrogen content).



Figure 4: Comparison between sunflower, rapeseed and microalgal oil production with biogas and photov. tech.

Method: ReCiPe Midpoint (H) V1.04 / Europe ReCiPe H / Characterization

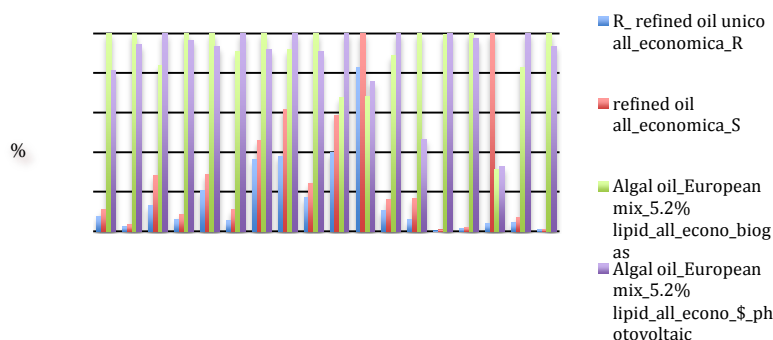

## 5. Conclusions

Despite their high potential as sustainable energy feedstock, microalgae are not yet competitive with the traditional oil crops in both economic and environmental impact. The main obstacle to their convenience on industrial scale still consists in the high energy demand in terms of electricity, heat and nutrients. The introduction of renewable energy in the production chain has proved that there are wide possibility to reduce the impact but this is still not enough to match the performance of crop land. On the other hand the expected increase in world population resulting in growing need of arable land, will lead to privilege second and third generation biofuels that do not compete with food production. In this perspective algae could play an important role but further research is necessary aimed at optimized the production chain and to value all useful co-products.

## 6. References

- [1] Brennan, L., Owende P., Biofuels from microalgae: A review of technologies for production, processing, and extractions of biofuels and co-products, *Ren. and Sust. Energy Reviews* **14**, 2009,557-577.
- [2] Molina Grima, E., Belarbi, E.H., Acien Fernandez, F.G., Robles Medina, A., Chisti, Y., Recovery of microalgal biomass and metabolites: process options and economics. *Biotechnol. Adv.* **20**, 2003,491–515.
- [3] Jorquera, O., Kiperstok, A., Sales, E.A., Embiruc\_u, M., Ghirardi, M.L., Comparative energy life-cycle analyses of microalgal biomass production in open ponds and photobioreactors. *Bioresour. Technol.* **101**,2010, 1406–1413.
- [4] Clarence A.F. et al., Environmental LCA comparison of algae to other bioenergy feedstock, *Environ. Sci.Technol.*, **44**(5)2010 1813-19.
- [5] Mark Goedkoop, Michiel Oele, An de Schryver, Marisa Vieira, Sander Hegger SimaPro Database Manual Methods library, PreConsultans 2010, 18-21.
- [6] Fierro A., Forte A., Measurements of CO<sub>2</sub> and N<sub>2</sub>O emissions in the agricultural field experiments of the MESCOSAGR project, in *Carbon Sequestration in agricultural soils*, Springer 2012, 229-59.
- [7] Schneider I., Finkbeiner M., LCA of EU oilseed crushing and vegetable oil refining, *report by FEDIOIL*, 2013.
- [8] Figueiredo F., et al, LCA of sunflower oil addressing alternative land use change scenario and practices, *8th International Conference on LCA in the Agri-Food Sector*, Rennes, France, 2-4 October 2012.
- [9] Wiley P.E. et al, Production of biodiesel and biogas from algae: a review of process train options, *Water Environ. Res.* **83** (4) 2011 326-38.
- [10] Martinez H.G., Martinez M.E., Sánchez S., Use of industrial wastewater from olive-oil extraction for biomass production of *Scenedesmus obliquus*, *Biores. Technol.* **99**,2008, 1111-1117.
- [11] Stephenson A.L et al., LCA of Potential Algal Biodiesel Production in the United Kingdom: A Comparison of Raceways and Air-Lift Tubular Bioreactors. *Energy Fuels* **24**, 2010, 4062–4077.
- [12] Collet, et al., LCA of microalgae culture coupled to biogas production. *Bioresource Technol.* **102**,2011, 207-14.
- [13] Skorupskaite V., Makareviciene V., Green energy from microalgae: usage of algae biomass for anaerobic digestion. *J. of Int. Sci. Pub.: Ecology and Safety* **8**, 2014,71-77.

# Liquid whey recycling within the traditional dairy chain, as a sustainable alternative for whey waste management

Nadia Palmieri<sup>1</sup>, Maria Bonaventura Forleo<sup>1</sup>, Elisabetta Salimei<sup>2</sup>, Luigi Perrella<sup>3</sup>

<sup>1</sup>Department of Economics, Management, Society and Institutions, University of Molise,  
Via F. De Sanctis, 86100 Campobasso, Italy

<sup>2</sup>Department of Agriculture, Environment and Food Sciences, University of Molise,  
Via F. De Sanctis, 86100 Campobasso, Italy.

<sup>3</sup>Caseificio Molisano L. Barone snc, Via Emilio Spensieri, 32, 86019 Vinchiatiuro, Campobasso. Italy  
E-mail contact: [nadia.palmieri@unimol.it](mailto:nadia.palmieri@unimol.it)

## 1. Abstract

*The world production of cheese whey, which is the main contaminant generated by the cheese industry, is estimated to be over 10<sup>8</sup> tons/y. In Italy, the cheese production in 2013 was 1.16<sup>6</sup> ton. Thanks to its nutritional value, liquid whey can be successfully recycled in animal nutrition. Following the LCA methodology, this study aims to assess the environmental impact of milk production within the traditional dairy chain. In three farms, different cow's diets were assessed and compared: farm A, with hay and no liquid whey; farm B, including silages but no liquid whey; farm C, including both silages and liquid whey. Finally, sensitivity analysis was conducted on allocation methods (mass vs. cereal unit) between milk and meat. Results have shown that farm C had the best environmental performance due to both silages/liquid whey use and milk yield per cow (29 L vs 28 L in farm B and 25.1 L in farm A). The same results were achieved in the cereal unit allocation, even if the mass allocation results were higher than those with cereal unit allocation. The identification of critical impacts along the production cycle and the comparison among the three cow's diets suggest those best practices that could improve the milk production sustainability in marginal areas typical in South Central Italy.*

**Keywords:** Life Cycle Assessment (LCA), milk production, cheese whey recycling, cow's diet.

## 2. Objectives, materials and method

The dairy industry is associated with the production of wastewaters and effluents that could have a significant environmental impact because of their pollutant characteristics [1]. The dairy waste that is receiving considerable attention is cheese whey [2], since approximately 1 kg cheese produces 10 L cheese whey [3]. In Italy, the cheese production in 2013 was 1.16<sup>6</sup> ton [4] while the world production of cheese whey is estimated to be over 10<sup>8</sup> tons per year [3]. Thanks to its high nutritional value, liquid whey can be recycled within the dairy chain for feeding animals. Aiming to contribute to an improved environmental sustainability of milk production in the traditional dairy chain while enhancing the animal well being, the study assesses the environmental impact of milk production by the means of different feeding strategies. Following the LCA methodology, animal diets including or not liquid whey were assessed and compared. We referred the environmental analysis to a sample of dairy farms located in inner areas of Molise region, Centre Italy. Despite the small size of the region, the local cheese production contributes approximately to 1.8% of the national cheese production [4] and has a strong traditional character [5]. The focus on few case studies is consistent with previous studies on milk production [6, 7, 8].

The environmental impact assessment has been carried out by comparing three farms where Italian Friesian dairy cows are raised following feeding strategies<sup>3</sup> summarised as: farm A, traditional feeding, *i.e.* hay and no liquid whey; farm B, including silages but no liquid whey [9]; farm C including both silages and liquid whey<sup>4</sup>. The considered system was defined by whole life cycle of cows (from birth and growth, to milk production) including the agricultural processes of feedstuffs. The liquid cheese whey, produced by “L. Barone snc”, was used in animal feeding as partial substitute of drinking water. All the system was consistent with the perspective “*from a cradle-to-gate*”. The functional unit (FU) was “*1 kg of energy corrected milk (ECM) at the farm gate*” in order to consider the fat and protein contents of the milk [6-7,10-12]. The mass allocation was previously used to share the environmental burden between milk and meat, then compared with an cereal unit allocation<sup>5</sup>. The method ReCipe Endpoint (H)/ Europe 1.09 was used. Weighing and characterization among farm units have been carried out to identify the farm with the highest impact and the main categories of impact at the “endpoint” and “midpoint” levels.

### 3. Results and discussion

The analysis of the environmental impact of milk production at “endpoint” level (Fig. 1) showed that farm A, was more impacting than farms B and C, mainly due to management of diets. The same results were achieved in the cereal unit allocation<sup>6</sup>, even if the mass allocation results were higher than those with cereal unit allocation. The use of commercial mixed feeds had the largest impact on all farms mainly as a consequence of soybean cultivation (an ingredient of mixed feeds)<sup>7</sup>. Moreover, in all the farms the main damaged category was the ecosystem.

---

<sup>3</sup> Cow’s diets (kg/head x d): farm A - 12 kg meadow hay, 3 kg mixed feed, 3 kg maize, 2.5 kg sugar beet pulp, 1.5 kg soy meal 44%, 1.5 kg barley and 90 liters of water; farm B - 13 kg triticale silage, 6 kg meadow hay, 3 kg mixed feed, 3 kg maize, 2.50 kg sugar beet pulp, 1.5 kg soy meal 44%, 1.5 kg barley and 80 liters of water; farm C - 13 kg triticale silage, 6 kg meadow hay, 3 kg mixed feed, 3 kg maize, 2.50 kg sugar beet pulp, 1.5 kg soy meal 44%, 1.5 kg barley and 50 liters of water plus 26 liters liquid whey.

<sup>4</sup> The potential diet D (hay and liquid whey) was not tested,

<sup>5</sup> The percentages of mass allocation were 88% and 12% for milk and meat, respectively [13]; while the cereal unit allocation was 86.6% to milk, 6.8% live-weight dairy cow and 6.6% to live-weight fattening calf [14]. All manure/slurry were used as a fertilizer in the crop production of the farms, therefore it was not necessary their allocation.

<sup>6</sup> For space reasons, results of the sensitivity analysis with the cereal allocation method were not reported.

<sup>7</sup> According to literature [15] mixed feed can be assimilated to the three major products -cereals, oilseeds, sugarbeet-, included in equal parts in the mix. Moreover, to evaluate environmental impact of mixed feed it was necessary to consider both the cereal cultivation and the industrial processes for each component including byproduct such as soybean meal and sugar beet pulp. For the cultivation phase we must consider the ratio between the quantity of agricultural raw material (*i.e.* cereal) necessary to produce 1 kg of processed feed (*i.e.* grain). According to local evaluations, 3.50 kg of cereal were necessary to produce 1 kg of processed grain, 5.88 kg of sugar beet were necessary per 1 kg of sugar beet pulp and 2.50 kg of soybean were necessary to produce 1 kg of soybean meal.

Figure 1: Environmental impacts of milk production at endpoint level (pt)

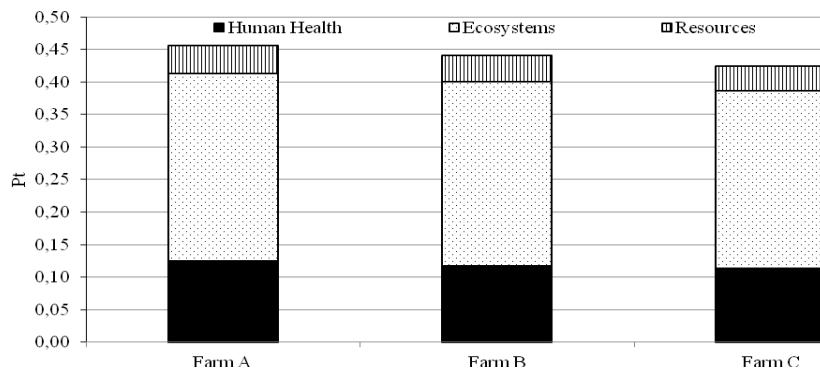

The characterization phase allocates the environmental impacts to the “midpoint” categories<sup>8</sup>.

The farm C showed a global best environmental performance, because its impacts account on average for about 86% of the impacts attributable to farm A. This means that switching from a case with hay and no liquid whey (farm A) to a diet including both feedstuffs (farm C) would result in a decreasing environmental impact. Comparing the farms for each impact category, farm A has a higher impact than farms B and C on all categories (figs. 2.a, 2.b) except on PMF and TA categories. The impact on PMF category was mainly caused by ammonia from forage cultivation for hay (farm A) and from grass cultivation for silage (farms B and C). The impacts of farms A and B on PMF category were similar in size (98 % vs 100%): that is because farm A included hay in rations and had the lowest daily milk yield, while farm B used silage in rations and had a higher daily milk yield<sup>9</sup>. The differences between the PMF impact of farms B and C were due to the daily yield (respectively 28 L and 29 L). The highest impact on TA category was observed in farm B, where it was due to the ammonia from grass cultivation for silage, followed by farm C.

Considering the impacts in absolute terms, among “midpoint level” categories belonging to human health (fig. 2.a), the highest impact is on CCHH category and it is due to the carbon dioxide caused by tractor fuel combustion in soybean cultivation (an ingredient of mixed feeds). This component of mixed feed was present in the diets of all farms, but the differences among their CCHH impact were mainly due to the different daily milk yield. As far as the PMF category, as above, absolute impacts derived mainly from ammonia. The impacts on HT category were caused by manganese coming from cereals cultivation. Among “midpoint level” categories belonging to ecosystems (fig. 2.b), the highest impact was on ALO, followed by

<sup>8</sup> The “midpoint level” categories are grouped at “endpoint level” into the categories of damage for human health, ecosystems and resources, as follows. Impact on human health by: climatic change on human health (CCHH), ozone layer depletion (OD), human toxicity (HT), formation of photochemical oxidants (POF), formation of particulates (PMF), and ionizing radiations (IR). Impacts on ecosystems: climatic change on ecosystems (CCE), land acidification (TA), freshwater eutrophication (FEu), terrestrial freshwater and marine eco-toxicity (TE, FEc, ME), urban and agricultural land occupation (ULO, ALO), the transformation of natural soil (NLT). Impact on natural resources: exhaustion of metals (MD) and fossil resources (FD).

<sup>9</sup> The farm A used 12 kg of hay in the cow’s diet with 25.1 L of daily milk yield per cow; farms B used 13 kg of silage with 28 L of daily milk yield per cow.

CCE categories. The soybean cultivation causes, for all farms, the above mentioned impact on ALO category. The impacts on CCE category were caused by carbon dioxide coming from tractor fuel combustion for soybean cultivation. Finally, between the two “midpoint level” categories belonging to resources (figure not shown) the highest impact is on FD category due to crude oil from fuel consumption, used for soybean cultivation (all diets).

In conclusion, farm C showed the least environmental impact due to cow’s diet (including both silages and liquid whey) and milk yield per cow (29 L vs 28 L of farm B and 25.1 L of farm A), confirming that impacts decrease at increasing milk yields [16].

Figure 2: Characterization: Human Health (2.a) and Ecosystems (2.b) impact categories<sup>10</sup> (legend: see note 6). The values expressed in DALY (2.a) and in species yr. units<sup>11</sup> (2.b) indicate the impact in absolute terms identified for each impact category on farms)

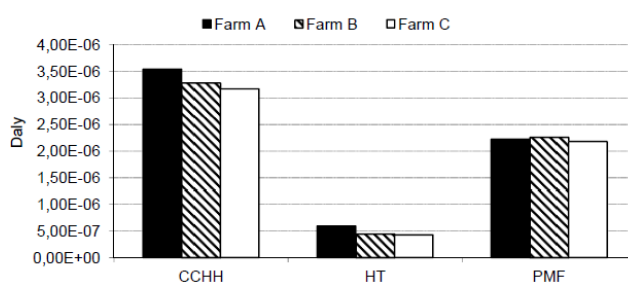

(2.a)

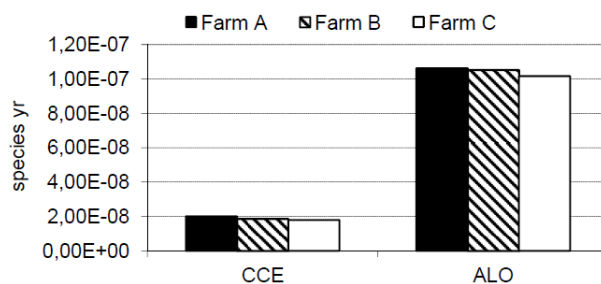

(2.b)

### 3. Conclusions

Using the LCA methodology, we assessed the environmental impact of milk production when liquid whey is introduced in balanced dairy cow rations partially substituting drinking water. Our results, although on a limited number of dairy farms, show that farm C, with both silages and liquid whey use, is the least impacting. This finding is mainly due to the different diet that increase the milk yield when the silages and the liquid whey are included. The best environmental performance of farm C compared to other farms suggests that the best feeding strategy consists in using silages and liquid whey in dairy rations. The study assesses the environmental impacts at farm level according to literature; while it lacks to consider the alternative liquid whey disposal from cheese production.

<sup>10</sup> Impacts less than 2.90E-9 were excluded due to graphical reasons.

<sup>11</sup> Daly (Disability Adjusted Life Years) was an index of disease weight, i.e. years in ill or lost to premature death. Species yr. unit was the number of living species lost per years due to the impact on ecosystems (Fiore et al., 2009).

Finally, intensifying the recycle of liquid whey and strengthening the relation at local level between cheese industries and dairy farms, the cost of whey transport could be reduced and the disposal costs of liquid whey would be eliminated, with positive environmental effects. The aforementioned benefits could contribute to innovate the dairy chain in South Centre Italy.

#### 4. References

- [1] Prazeres, A.R., Carvalho F. and Rivas, J., 'Review Cheese whey management: A review', *J. Environ. Manage.* **110** (2012) 48-68.
- [2] Mirabella, N., Castellani, V. and Sala, S., 'Current options for the valorization of food manufacturing waste: a review', *J. Clean. Prod.* **65** (2014) 28-41.
- [3] Lustrato, G., Salimei, E., Alfano, G., Belli, C., Fantuz, F., Grazia, L. and Ranalli, G., 'Cheese whey recycling in traditional dairy food chain: effects of vinegar from whey in dairy cow nutrition', *Acetic Acid Bact.* **2** (1) (2013) 8.
- [4] ISTAT, (2013). Agriculture and livestock database, Italy. <http://agri.istat.it/>.
- [5] Molise Region PSR 2014-2020. <http://www3.regione.molise.it/flex/cm/pages/ServeBLOB.php/L/IT/IDPagina/10130>.
- [6] Cederberg, C. and Flysjö, A., 'Life Cycle Inventory of 23 Dairy Farms in South-Western Sweden', SIK-rapport 728 (2004). ISBN 91-7290-237-X. [http://www.sik.se/archive/pdf-filer-katalog/SR728\(1\).pdf](http://www.sik.se/archive/pdf-filer-katalog/SR728(1).pdf).
- [7] Cederberg, C. and Mattsson, B., 'Life cycle assessment of milk production - a comparison of conventional and organic farming', *J. Clean. Prod.* **8** (1) (2000) 49-60.
- [8] Guerci, M., Bava, L., Zucali, M., Tamburini, A. and Sandrucci, A., 'Effect of summer grazing on carbon footprint of milk in Italian Alps: a sensitivity approach', *J. Clean. Prod.* **73** (2014) 236-244.
- [9] Palmieri, N., Forleo, M.B., Zurlo, N. and Salimei, E., 'Life cycle assessment of conventional and organic milk production', in 'Sustainability of the agri-food system: Strategies and Performances', Proceedings of the 50th SIDEA Conference 2014, 175-187.
- [10] Yan, M.J., Humphreys, J. and Holden, N.M., 'Review An evaluation of life cycle assessment of European milk production', *J. Environ. Manage.* **92** (3) (2011) 372-9.
- [11] Flysjö, A., Henriksson, M., Cederberg, C., Ledgard, S. and Englund, J.E. 'The impact of various parameters on the carbon footprint of milk production in New Zealand and Sweden', *Agr. Syst.* **104** (6) (2011a) 459-469.
- [12] Flysjö, A., Cederberg, C., Henriksson, M. and Ledgard, S., 'How does co-product handling affect the carbon footprint of milk? Case study of milk production in New Zealand and Sweden', *Int J Life Cycle Assess.* **16** (2011b) 420-430.
- [13] Milani, F.X., Nutter, D. and Thoma, G., 'Invited review: Environmental impacts of dairy processing and products: A review', *J. Dairy Sci.* **94** (2011) 4243-4254.
- [14] Brankatschk G., Finkbeiner M., 'Application of the Cereal Unit in a new allocation procedure for agricultural life cycle assessments', *J. Clean. Prod* **73** (2014) 72-79.
- [15] Cecchini, F., Falconi, F., Franchini, F., Neri, P., Aradeo, E., Barbiroli, G., Bombardieri, R., Corsari, A. and Di Stefano M., 'Analisi del Ciclo di Vita di 11 di latte UHT della ditta Granarolo', Doc. ENEA (2004) PROT-INN 135-046.
- [16] Nemecek, T., Schmid, A., Alig, M., Schnebli, K. and Vaihinger, M., 'Variability of the Global Warming Potential and Energy Demand of Swiss Cheese', in 'Proceedings of SETAC Europe 17<sup>th</sup> LCA Case Studies Symposium- Sustainable Lifestyles, Budapest, Hungary, 28 February - 1 March 2011, 57-58.

# Quantification of life cycle energy use for a more efficient building design

Authors: Fabiana Ricci<sup>1</sup>, Sara Toniolo<sup>1</sup>, Anna Mazzi<sup>1</sup>, Filippo Aguiari<sup>1</sup>, Antonio Scipioni<sup>1</sup>

<sup>1</sup> CESQA (Quality and Environmental Research Center), University of Padova, Department of Industrial Engineering,  
Via Marzolo 9, 35131 Padova, Italy  
E-mail contact: [fabri.ricci.84@gmail.com](mailto:fabri.ricci.84@gmail.com)

## 1. Abstract

*The purpose of this work is to verify the possibility to adopt planning tools, well known among technicians, to improve the building energy efficiency in a life cycle perspective and to verify if these tools can lead to embodied energy results comparable with a specific case study. The aim is to use these results to quantify ALCE, Annualized Life Cycle Energy, value. Starting from a published LCA study about an existing ZEB (Zero Energy-Emission Building) building, its planning was simulated and the embodied energy values were deduced converting the inventory data. Results were comparable for the specific case study for most of the manufacturing phases, with a difference lower than 15%, and they were used in to calculate ALCE. Final values shows that ALCE is an indicator able to represent the task to minimize building energy use and so improving energy efficiency in the constructions sector.*

## 2. Introduction

Energy efficiency of a building can be seen as the ability to guarantee delivery of services using lower amount of primary energy as possible, thus, a high system efficiency concurs with low energy consumption in ensuring building energy needs. Therefore, goal of energy efficiency is the reduction of energy wastefulness. However, besides the building use phase, it is suitable to reduce the energy linked to the overall system life cycle, defined as embodied energy, or virtual, or hidden energy [1]. LCA (Life Cycle Assessment), which assesses potential impacts associated with the overall life cycle of processes and products, allows enhancing the building efficiency. This methodology permits to highlight, among all energy forms, the embodied energy, particularly significant in the constructions sector, used as a discriminating factor for planning choices since the preliminary project phases. This is especially important for buildings such as Nearly ZEBs, which are characterized by low energy requirements (between 0 and 15 kWh/mq year), with almost no direct emissions [2] and where the energy delivered by the system is balanced with the energy produced [3,4]. The addition of embodied energy within the energy balance can distance the building from the ZEB target [5] because it extends the analysis above the operational phase. Therefore, a new energy efficiency target in the constructions sector was defined: the LC-ZEB, Life Cycle-Zero Emission Building, which considers the building energy balance between delivered and produced energy, taking into account the overall system embodied energy through ALCE value. In previous LCA studies, life cycle embodied energy is quantified through CED (Cumulative Energy Demand) evaluation method expressed in terms of MJ [6]. Embodied energy dissertation is turning to overtake the importance of direct emissions [7, 8].

The goals of this study are:

- Verifying the existence of well-known planning tools to enhance building energy efficiency calculations in a life cycle perspective;
- Assessing if they can lead to results that are comparable with the outcomes of a specific case study in order to calculate ALCE value.

### 3. Materials and methods

According to the goals of this work, a published LCA study on existing ZEB building was considered. We simulated the overall planning starting from the architectural modeling using AutoCAD tool. Furthermore, the metric estimate was elaborated to define the “Bills of Materials”. This amount of materials were converted in embodied energy through ICE (Inventory of Carbon and Energy), a free database created by Bath University including more than 400 constructions materials embodied energy unitary values [9]. Moreover, a time line chart (Gantt diagram) was developed to quantify the manufacturing duration and the on-site engines and transports time use to convert them in embodied energy values through literature factors. The obtained embodied energy results were compared with the outcomes of the reference case study, and they were used to calculate ALCE expression terms. The case study was specifically selected because it analysed the same building of our work. ALCE value was important to define the building energy use needs in a life cycle perspective and was obtained by the sum of AEU (Annualized Energy Use) and AEE (Annualized Embodied Energy) for every component and every manufacturing phase. A building can be considered a LC-ZEB if it respects the equation [E1]. Thus AEU value must be lower than zero.

$$ALCE = AEU + AEE = 0 \quad [E1]$$

According to the equation [E1], it is necessary that the building system plant produces more energy (E out) than building needs, installing high efficiency plants using renewable resources [10]. We have to consider these active energy producing systems like any other building component, especially for their contribution in the total embodied energy amount that will be included in the AEE computation [11].

### 4. Results and discussion

Table 1 shows results of this work and the reference case study. The comparison was carried out for every building manufacturing phase.



Table 1: Comparison between the results obtained in this study and results of reference case study

Results of this study		Unit	Reference case study		Unit	Difference (%)
Support structure	2,61	MWh/y	Support structure	2,32	MWh/y	12
Foundations structure	1,60	MWh/y	Foundations	1,55	MWh/y	3
Ground air garret	1,44	MWh/y	Garret	13,27	MWh/y	5
Intermediate garret	5,20	MWh/y				
Outdoor	0,22	MWh/y				
Frame	12,78	MWh/y	Frame	3,24	MWh/y	
External walls	7,59	MWh/y	External walls	8,9	MWh/y	13
External doors and windows	0,15	MWh/y				
Internal walls	1,22	MWh/y	Internal walls	1,3	MWh/y	6
Internal doors	0,10	MWh/y				
Transports	1,05	MWh/y	Transports	1,14	MWh/y	7
Construction site	5,17	MWh/y	Construction site	0,08	MWh/y	-

The embodied energy materials differs for a percentage lower than 15%, which is our threshold limit, when compared to the case study for most of the manufacturing phases: support structures 12%, foundations 3%, external walls 13%, internal walls 6%, frame and garret 5%, transports 7%.

However, the difference between results regarding the construction site is significant, because of on-site engines, transport and employers embodied energy. ALCE value was calculated summing the AEE term, equal to 53,58 MWh/y, to the building annualized energy use AEU previously found, equal to 34 MWh/y. The final value of ALCE, thus, is 87,508 MWh/y. Furthermore, the building energy produced by the system (E out) was quantified resulting equal to 172 MWh/y. This value is higher than the AEU one, despite the embodied energy in the overall building energy balance. However, the difference between the two values decreases when the life cycle perspective is considered. Finally, AEE were higher than AEU, demonstrating that embodied energy was not a negligible building analysis element.

## 5. Conclusions

The aim of this study is to propose an applicable method to increase the constructions sector sustainability and efficiency considering LCA perspective. The proposed approach allows gaining a complete building embodied energy picture linked to the overall system life cycle using well-known tools normally utilized by technicians. Sinergy between architectural planning and LCA leads to a more realistic impacts awareness in all manufacturing phases because the variation of embodied energy is directly linked to the project amount. LCA methodology and CED evaluation method, which coincides with embodied energy, allow quantifying ALCE, that represents the task to minimize building energy use and so improving energy efficiency in the constructions environment [12].

## 6. References

- [1] Casalena, A.U., 'My Green Building'(2015), <http://www.mygreenbuildings.org/2011/05/02/life-cycle-assessment-lca-banca-dati-energia-grigia-materiali-edili.html>.
- [2] UNI EN 15603, 'Prestazione energetica degli edifici-Consumo energetico globale e definizione dei metodi di valutazione energetica' (2008).
- [3] Kurnitski,J., Allard,F., Braham,D., Goeders,G., Heisenberg,P., Jagermar, L., Kosonen, R., Lebrun, J., Mazzarella, L., Rallio, J., Seppanem, O., Schmidt, M., Virta, M., 'How to define nearly zero energy buildings nZEB', REHVA Task Force proposal for uniformed national implemmentation of EPBD recast, Denmark (2012).
- [4] Breggren, B., Wal, M., Flodberg, K., Sandberg, E., 'Net ZEB office in Sweden-A case study,testing the Swedish Net ZEB definition', International Journal of Sustainable Built Environment 1 (2012) 217-226.
- [5] Deng, S., Wang, R.Z., Dal, T.J., 'How to evaluate performance of net zero energy building-A literature research', Energy 7 (2014) 1-16.
- [6] G. Habert, G., E. Castillo, E., J.C. Morel, J.C., 'Sustainable Indicators for Resources and Energy in Building Construction',Second International Conference on Sustainable Construction Materials and Technologies (28-30 Giugno 2010).
- [7] C.Thomark, C., 'A low energy building in a life cycle– its embodie energy,energy need for operation and recycling potential', Building and Environment 37 (4) (2002) 429-435.
- [8] S. Rawlinson, S., Weight, D., 'Sustainability:embodied carbon', Building Magazine 12 (October 2007) 88-91.
- [9] Hammond, G.P., Jones, C.I., 'Embodied energy and carbon in construction materials', Proceedings of the Institution of Civil Engineers, Energy 161 (2) (2008) 87-98.
- [10] Hernandez, P., Kenny, P., 'From net energy to zero energy buildings:defining life cycle zero energy buildings (LC-ZEB)', Energy and Buildings 42 (2010) 815-821.
- [11] Pacca, S., Sivaraman, D., Keoleian, G.A., 'Parameters affecting the life cycle performance of PV technologies and systems', Energy Policy 35 (6) (2007) 3316-3326.
- [12] P.Hernandez, P., Kenny, P., 'Defining zero energy buildings-a life cycle perspective', PLEA 2008 – 25th Conference on Passive and low energy architecture, Dublin, Ireland, 2008.

# Resource footprint of Vietnamese Pangasius frozen fillets and export to the European market

Trang T. Nhu<sup>1</sup>, Thomas Schaubroeck<sup>1</sup>, Steven De Meester<sup>1</sup>, Michiel Duyvejonck<sup>1</sup>, Patrick Sorgeloos<sup>2</sup>, Jo Dewulf<sup>1</sup>

<sup>1</sup>Research Group EnVOC, Department of Sustainable Organic Chemistry and Technology, Gent University, Coupure Links 653, B-9000 Gent, Belgium

<sup>2</sup>Laboratory of Aquaculture & Artemia Reference Center, Ghent University, Rozier 44, B-9000 Gent, Belgium

E-mail contact: [Trang.nhuthuy@ugent.be](mailto:Trang.nhuthuy@ugent.be)

## 1. Abstract

*This study answers the question how resource efficient the production of Vietnamese Pangasius frozen fillets, an important alternative within the low-priced fish class, is. Resource usage was assessed as the Cumulative Exergy Extraction from the Natural Environment (CEENE), using the CEENE method, over a cradle-to-retailer life cycle: aquaculture, processing in Vietnam and transport to the Belgian retailers (EU). One tonne of dry matter (DM) of frozen fillets (excluding the water and chemical absorption) extracted 627 GJex, mainly through land occupation (48%, primarily for cultivating crop-based feed ingredients), water usage (33%, primarily for pond water renewal) and fossil fuel use (15%, primarily for energy use in processing and transport). Improvements in aquaculture (81% of the CEENE) were addressed by Huysveld et al. [1] Processing (14%) should use less electricity and packaging materials.*

## 2. Introduction

Pangasius is a relatively recent arrival on the international market; however, it is nowadays an important alternative within the low-priced fish class. Vietnam dominates its production while the main importers are the United States of America (USA) and the European Union (EU) [2]. As these are developed countries, more concern is therefore paid to the environmental performance of Pangasius production, particularly its resource footprint. This study aims to quantify the natural resource demand of Pangasius frozen fillets from cradle to the Belgian retailers (EU) by applying the Exergetic Life cycle assessment, in which resource consumption on a life cycle level is quantified as the Cumulative Exergy Extraction from the Natural Environment (CEENE) [3]. Above that, we suggest improvements to this sector based on identified environmental hotspots in terms of resource footprint within the aquaculture, processing, and transport stages.

## 3. Materials and Methods

### 3.1 Goal and scope

The system boundary was a full cradle-to-retailer life cycle of Pangasius frozen fillets, including aquaculture (i.e., feed production, hatchery and fish cultivation), processing in Vietnam and transportation to the Belgium retailer (Figure 1). The functional unit (FU) was one tonne of dry matter (DM) of frozen fillets (excluding the water and chemical absorption during processing). Labour, machinery and infrastructure were excluded in this analysis.

Figure 1: System boundaries of the Vietnamese *Pangasius* frozen fillet production and transportation to Belgian retailer [4]

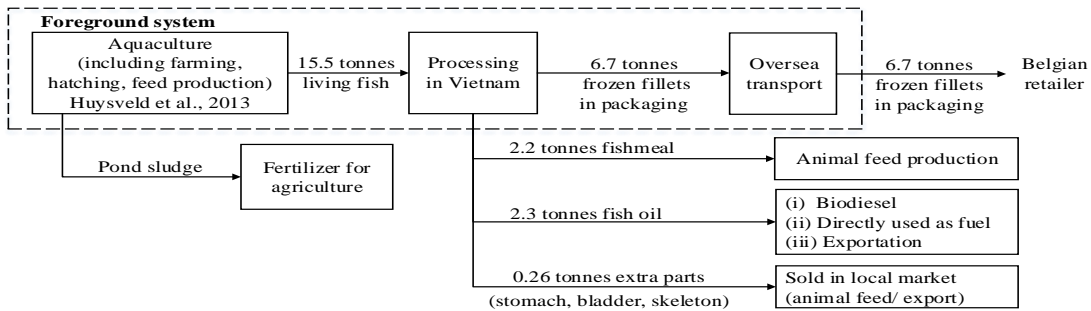

### 3.2 Life cycle inventory

Description and inventory of *Pangasius* aquaculture were derived from Huysveld et al. [1]. Foreground data of the processing and transportation were collected onsite between July and September of 2010 at a representative Vietnamese seafood producer under the condition of anonymity. The processing in Vietnam consisted of fillet processing (i.e., filleting, soaking, freezing, glazing, packaging, and storing) and its supporting system (i.e., groundwater treatment for a supply to the core system, wastewater treatment, and valorisation of fish trimmings to by-products: fishmeal, fish oil and extra parts (i.e., stomach, bladder, skeleton)). Several scenarios were possible in the fillet processing, depending on the import market requirements. This study focused on the scenario meeting the specifications of EU retailers, i.e., frozen fillets with a weight gain of 14% during soaking, 10% during glazing and individual quick packaging of 350 kg per package (IQF350). Background system processes were derived from the Ecoinvent v.2.2 database [5]. Electricity used for Vietnamese production and for cold ironing in a Malaysian harbour was modelled by using the Czech electricity production datasets available in Ecoinvent to model the 10-year (2003-2012) electricity production mix in Vietnam and Malaysia, reported by the International Energy Agency [6]. According to the ISO guidelines, when system expansion is not practically feasible, allocation based on physical properties (i.e., exergy content) should be preferred above economic allocation. The exergy content grasps both quantity and quality of a flow, hence this physical metric was used for allocation.

### 3.3 Life cycle impact assessment

Resource footprint was addressed in terms of exergy, or more specially, the Cumulative Exergy Extraction from the Natural Environment (CEENE) method [3]. This study applied the CEENE v.2013 method [7] which introduced the potential net primary production as a better proxy for land occupation compared to the photosynthetic solar exergy applied in the CEENE v.2007 [3]. A more comprehensive explanation about the rationale of the CEENE v.2013 can be found in the work of Alvarenga et al. [7] and Nhu et al. [4]. *Pangasius* aquaculture reported by Huysveld et al. [1] was applied this new approach by using site-specific land occupation characterisation factors (CF) along with adapting land occupation ( $\text{ha} \cdot \text{yr} \cdot \text{kg}^{-1}$ ) of feed ingredient (e.g., wheat, soymeal, etc.) production based on their origins (Table 1 in Huysveld et al. [1]) using a 10-year (2003-2012) average productivity.

For the background system, the European-average land occupation CF was applied to calculate the CEENE of industrial products (e.g., electricity, chemicals, etc.) for simplification.

#### 4. Results and Discussions

For the chosen scenario, the total CEENE, i.e. the natural resource consumption over the cradle-to-retailer life cycle, amounted to 627 GJex per tonne of DM frozen fillets corresponding to 6.2 tonnes of frozen fillets in 0.5 tonnes packaging. With respect to the types of resources, the largest contributors were land occupation (48%, primarily for cultivating crop-based feed ingredients), water usage (33%, primarily for pond water renewal), and fossil fuel consumption (15%, primarily for energy use in processing and transport). Aquaculture (81%), particularly on-farm activities: feed usage (50%) and water renewal (22%), took the largest share in the total CEENE and was followed by other inputs of the fillet processing (14%) and oversea transport (5%). The end-of-life disposal of packaging around frozen fillets was noted for its dependence on the waste disposal policy of imported markets. This packaging was recycled (i.e., plastic and cardboard) and reused (i.e., wooden pallets) in Belgium, which subtracted 40 GJex FU<sup>-1</sup> from the total CEENE via replacement of virgin materials. Along with one tonne of DM frozen fillets (FU), the Vietnamese producer delivered 2.2 tonnes of fishmeal, 2.3 tonnes of fish oil and 0.26 tonnes of extra parts, corresponding to CEENE values of 932 GJex, 1950 GJex and 38 GJex, respectively. The CEENE of other inputs of the processing in Vietnam, except aquaculture contribution, amounted to 155 GJex FU<sup>-1</sup>, of which land (40%), fossil fuels (32%) and water (23%) contributed primarily. Improvements in aquaculture were addressed in Huysveld et al. [1] Improvements in the processing should focus on identified hotspots, i.e., the consumption of electricity (26%), packaging (27%), and rice husks as an energy source for the boiler in by-product valorisation (30%). One may install capacitor banks to improve the power factor in addition to monitoring electricity usage for individual operations. Processing wastewater could be utilized as a feedstock of anaerobic digestion, which allows a positive energy balance [8] corresponding to an estimated saving of 6.8 GJex FU<sup>-1</sup>. Other effective options could be: reducing the fillet weight gain in glazing and/or soaking and changing the packaging scenario, which were discussed in Nhu et al. [4].

Figure 2: Overall cradle-to-retailer resource footprint of *Pangasius* frozen fillets (IQF350)

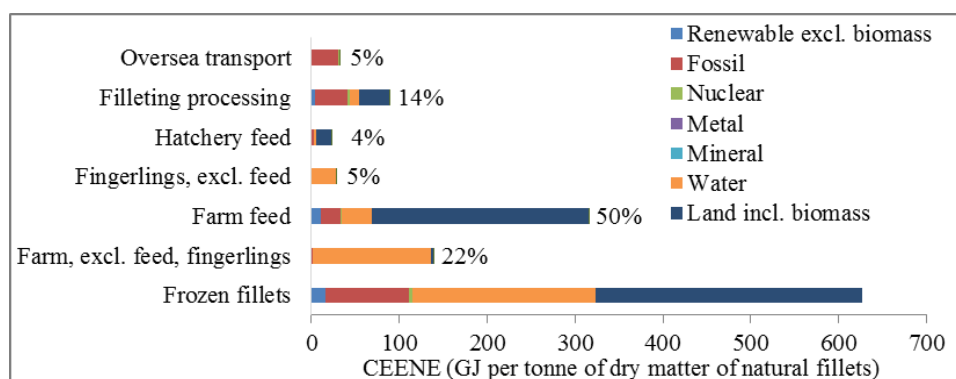

## 5. Conclusion

Aquaculture, specifically grow-out farming, was identified as the hotspot of Pangasius frozen fillets with respect to resource footprint. Improvements in this stage was addressed by Huysveld et al. [1] Regarding processing, in addition to lowering the consumption of electricity and packaging materials, life cycle thinking should be introduced to Pangasius importers because their choices in the characteristics of imported frozen fillets and the disposal of packaging around the fillets directly influence the resource footprint of this product. For more information on this work, please read our related work [4].

## Acknowledgement.

We wish to thank the Special Research Fund (BOF, number: 01D03311) of Ghent University, Belgium.

## 6. References

- [1] Huysveld, S., Schaubroeck, T., De Meester, S., Sorgeloos, P., Van Langenhove, H., Van Linden, V., Dewulf, J., 'Resource use analysis of Pangasius aquaculture in the Mekong Delta in Vietnam using Exergetic Life Cycle Assessment', *J. Clean. Prod.* 51 (2013) 225-233.
- [2] FAO, 'The state of World Fisheries and Aquaculture', (Italy, 2012).
- [3] Dewulf, J., Bosch, M. E., Meester, B. D., Vorst, G. V. D., Langenhove, H. V., Hellweg, S., Huijbregts, M. A. J., 'Cumulative Exergy Extraction from the Natural Environment (CEENE): a comprehensive Life Cycle Impact Assessment method for resource counting', *Environ. Sci. Technol.* 41 (2007) 8477 - 8483.
- [4] Nhu, T. T., Schaubroeck, T., De Meester, S., Duyvejonck, M., Sorgeloos, P., Dewulf, J., 'Resource consumption assessment of Pangasius fillet products from Vietnamese aquaculture to European retailers', *J. Clean. Prod.* 100 (2015) 170-178.
- [5] Swiss Centre for Life Cycle Inventories, <http://www.ecoinvent.org/> [accessed 20.01.2015].
- [6] IEA, <http://www.iea.org> [accessed 20.01.2015].
- [7] Alvarenga, R. A. F., Dewulf, J., Van Langenhove, H., Huijbregts, M. A. J., 'Exergy-based accounting for land as a natural resource in life cycle assessment', *Int. J. Life Cycle Ass.* 18 (2013) 939-947.
- [8] Trautmann, N., Beier, M., Phan, L. C., Rosenwinkel, K. H., 'A new approach to energy-efficient treatment of wastewater produced by the fish industry in Vietnam', *Water Sci. Technol.* 64 (2011) 279-285.

# Comparative LCA of bread baked in novel Low Energy Ovens and conventional ovens

Author(s): Laura Batlle Bayer<sup>1</sup>, Bart Durlinger<sup>1</sup>, Roline Broekema<sup>1</sup>

<sup>1</sup> Blonk Consultants, Gravin Beatrixstraat 34, Gouda

*E-mail contact:* [bart@blonkconsultants.nl](mailto:bart@blonkconsultants.nl)

## 1. Abstract

*This paper presents the preliminary results of a comparative Life Cycle Assessment of conventional bread baking ovens and novel bread baking ovens based on infra-red (IR) technology. This LCA is being executed for the EU FP7 research project “Enabling small-to-medium sized oven technology producers and bakeries to exploit innovative Low Energy Ovens” (LEO). The overall goal of the LEO project is to develop and test three types of low energy ovens based on infra-red baking technology: a deck oven, a convection oven and a conveyor oven. The measurements taken during the energy tests form the input for the LCA. Additional environmental data was gathered for oven materials and manufacture, and the production bread ingredients. As testing is currently still in progress, only preliminary outcomes are presented in this abstract.*

## 2. Introduction

Bread is an essential food product in European diets, with an average annual consumption of 58 kg per person and a production of about 35 million tonnes in 2012 in Europe [1][2]. During the process of bread production, environmental impacts result, for instance, from the use of natural resources (e.g. land for wheat cultivation), energy (e.g. energy for baking) and fuel (e.g. transport of grain, flour and bread).

Within the context of the European FP7 Research Project -”Enabling small-to-medium sized oven technology producers and bakeries to exploit innovative Low Energy Ovens” (LEO) (<http://leo-fp7.eu/>), we present preliminary results on the comparative Life Cycle Assessment (LCA) of three types of conventional bread baking ovens - a deck, a convection and a conveyor ovens (Figure 1) - and a novel bread baking oven based on infra-red (IR) technology.

## 3. Methodology

The IR conveyor oven was developed by consortium partner IRCON and Ramalhos manufactured the deck and convection ovens. The energy use/efficiency of the ovens (conventional and IR technology) was tested in the laboratory by ONIRIS and SP Food and Bioscience. Successively, the new IR prototype ovens will also be tested by two medium-size bakeries: (1) BPA-Nantes in France, and (2) Die Havenbäcker in Germany. At this stage, two types of bread recipes and sizes were selected to be tested in the three new IR ovens and the two reference ovens.

Figure 1: Type of bread baking ovens used in this study: a) Deck, b) Convection and c) Conveyor ovens



#### 4. Scope of the study

The functional unit of this study is the consumption of 1 kilogram of ready baked bread by the consumer.

The recipes and the weight of the bread are a basis for the reference flows, which are based on the functional unit. Losses of ingredients during in the retail are assumed to be 20%<sup>12</sup>, and bread waste is based on national statistics.

The life cycle of the bread production systems is shown in Figure 2. The system boundaries are cradle-to-grave, and an attributional approach is used to model the process system. Some processes are excluded in this study such as human labour, land-use change (due to low change in wheat production in France and Germany), and capital equipment is included as much as practically feasible.

Figure 2: Simplified diagram of the system boundaries

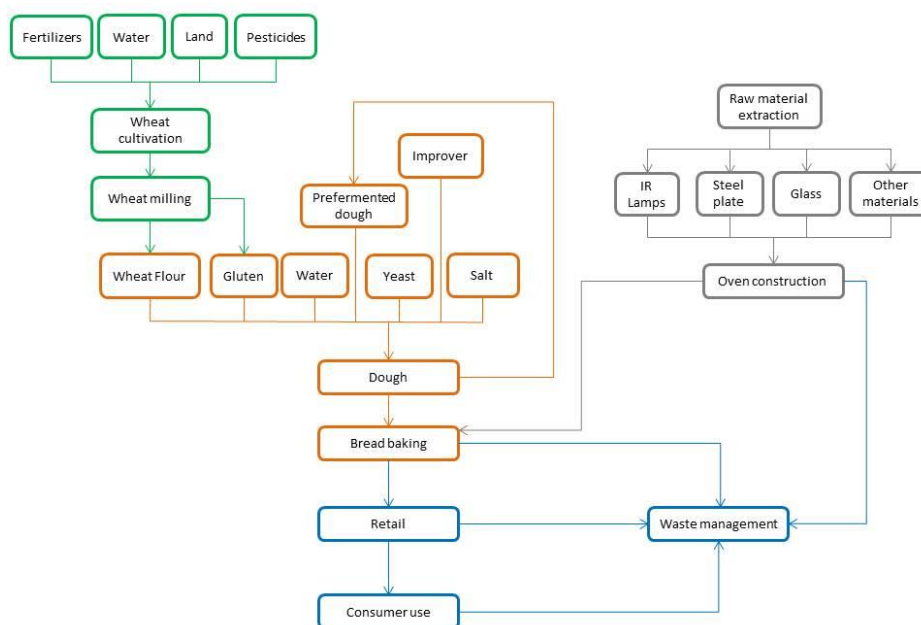

<sup>12</sup> <http://www.deutsche-handwerks-zeitung.de/zu-viel-brot-landet-im-muell/150/3094/283177>



Besides the ovens, some capital equipment is present in the background datasets from Ecoinvent 2.2 [3], for example in energy production processes. The chosen LCIA method is ILCD 2011 Midpoint v1.05 [4], and all midpoint indicators are taken into account to determine “the environmental impact” as broadly as possible. The optional LCIA element normalization is not part of this study and neither is weighting applied. For the Life Cycle Inventory (LCI), primary data was used for the bread baking process, while secondary data was used for the cultivation and retail-consumer and water management phases. Data quality requirements, which are applicable on the life cycle inventories, follow the requirements (e.g. precision, representativeness, uncertainty) stated in section 4.2.3.6.2 of the ISO 14044 [5].

## 5. Preliminary Results

Figure 3 shows preliminary results of the environmental impacts of producing 1 kg of bread with three different types of ovens. For all impacts, bread baking with a conventional deck oven had the highest impact due to its higher energy use during bread baking, especially for the pre-heating of the oven and the steaming. Data on energy use of new deck and convection ovens with IR technology are being gathered, and final results will be shown during the conference.

Figure 3: Impact contribution of different phases of producing 1 kg of bread: (1) Wheat flour, (2) Bread dough – mixing and (3) Baking Bread. Type of impacts: a) Climate change impact; b) Fossil fuel depletion, c) Terrestrial acidification, d) Freshwater eutrophication. REF: Reference (conventional); IR: Infrared technology

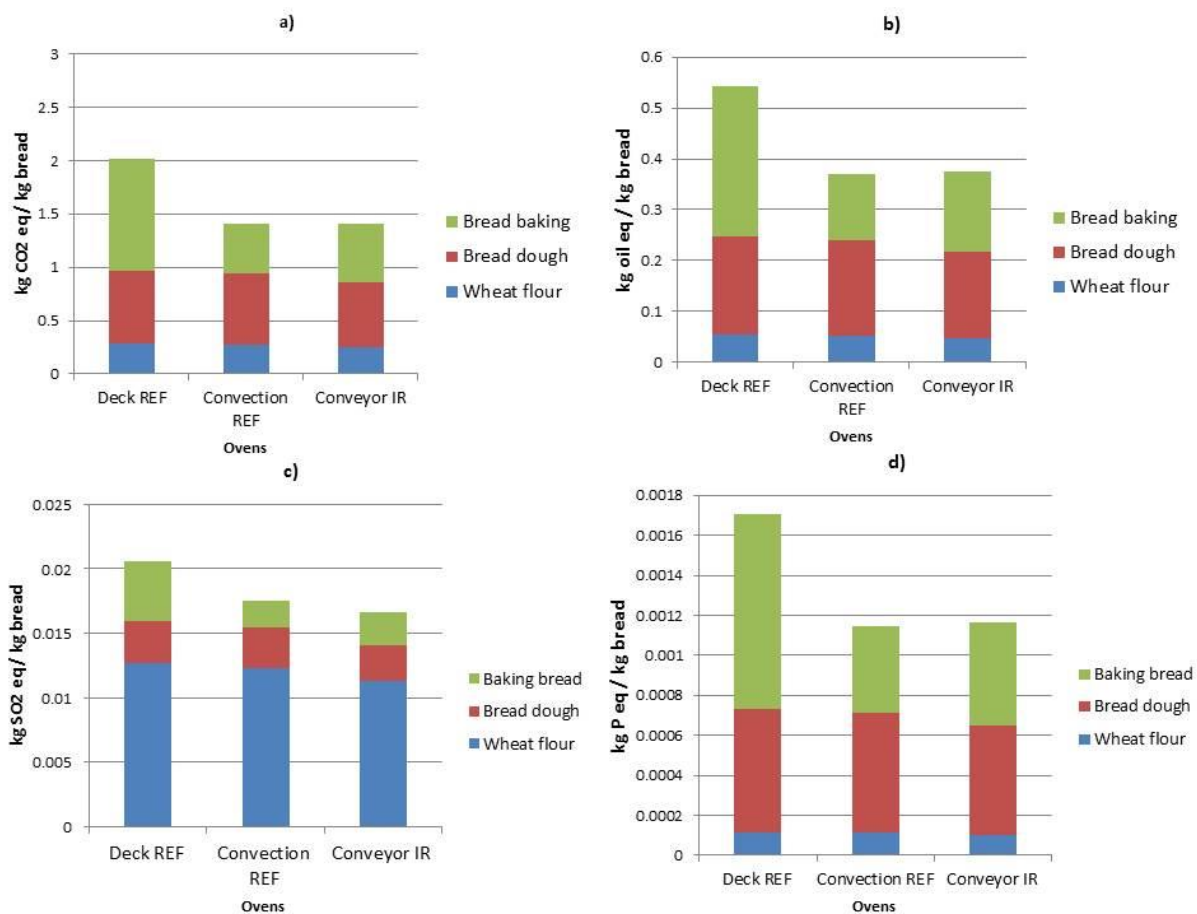

## **6. Conclusion**

The final LCA will compare the life cycle impacts for a large array of scenarios; analyses will be made for the three infrared ovens, two conventional ovens, two different bread recipes, three different bread sizes and in two different European countries (Germany and France). By looking at such a wide range of scenarios, it will be possible to derive robust conclusions on the environmental potential of the new infrared oven types. In addition, the assessment provides a opportunity to identify environmental hotspots and potential areas for improvement.

## **7. References**

- [1] AISBL, “AIBI Bread Market Report 2012,” 2013.
- [2] FP7 “Low Energy Ovens” project, “Bakery and Bake-off market research report.” .
- [3] R. Frischknecht, N. Jungbluth, H. Althaus, G. Doka, R. Dones, T. Heck, S. Hellweg, R. Hischier, T. Nemecek, G. Rebitzer, and M. Spielmann, “Ecoinvent - Overview and Methodology.” Ecoinvent, pp. 1–77, 2007.
- [4] JRC-IES, “ILCD Handbook - General guide for life cycle assessment - detailed guidance,” 2010.
- [5] ISO, “ISO 14044 - Environmental management — Life cycle assessment — Requirements and guidelines,” ISO, 2006.

# Life Cycle Assessment of the production and import of Arabica Brazilian coffee

Anna Maria Ferrari, Leonardo Guagliumi, Martina Pini, Sara Mohaddes Khorassani, Elisabetta Zerazion, Paolo Neri  
Department of Sciences and Methods for Engineering, University of Modena and Reggio Emilia,  
Via Amendola 2, 42100 Reggio Emilia, Italy  
E-mail contact: [annamaria.ferrari@unimore.it](mailto:annamaria.ferrari@unimore.it)

## 1. Abstract

*This study aims to apply the Life Cycle Assessment analysis to coffee following the product through its production steps: tillage, harvest, processing and importation. Social issues were also taken into account. The analysis was focused on the Arabica green coffee variety produced in the state of Minas Gerais in Brazil and imported to Italy by Illycaffè S.p.A.. The LCA analysis shows that coffee beans cultivation has the major impact compared with the import phase mainly due to land use.*

## 2. Introduction

The global coffee market worth approximately 100.000 billion dollar and it is characterized by the presence of 60 coffee producing countries. Brazil and Colombia together command approximately half of the world market, while the remaining countries have small market shares. Following the ICO (International Coffee Organization) statistics these countries together represent more than half of the world coffee beans turnover and have about 60% ÷ 70% of the market share. In particular Brazil is the world's biggest producer of coffee beans with approx. a 35% market share [1].

Depending on climate conditions, Brazil annually produces about 35 ÷ 40 million of coffee beans bags of which 30 million are exported, while 10 million are intended to domestic consumption making Brazil the world's third largest coffee-consuming country. Five states produce coffee in Brazil (Minas Gerais – 56.3%, Espírito Santo – 23.8%, São Paulo – 8.1%, Paraná-Bahia – 7.1% and Rondônia-Demais – 4.6% with several differences in all the production aspects. The Brazilian cultivations and consequently the coffee quality are influenced by different factors among which local topography conditions, size of the coffee production areas, adopted spacer and coffee production and processing technology. These conditions combined with coffee cultivation management (intensive, extensive, mechanical or manual) determine the coffee beans varieties harvested.

There are two coffee preparation methods: the dry method and wet method. Both methods have the following common stages: cleaning, separation, drying, storage, processing and classification. Additionally, the wet method includes the separation of red coffee berries, pulp removal, mucilage removal and product washing [2].

The goal of this paper is to analyse the environmental sustainability of a complete green coffee beans cultivation. In particular, this study aims to apply the Life Cycle Assessment analysis to coffee following the product through its production steps: tillage, harvest, processing and importation. The analysis was focused on the Arabica green coffee variety produced by the wet processing in the state of Minas Gerais and imported to Italy by Illycaffè S.p.A.

### 3. Materials and Methods

The scope of the present study is to assess the environmental impacts of the Brazilian production and import to Italy of green coffee for the reference crops 2012/2013. In order to highlight the positive impacts over the population, the local community and the large Brazilian community the HDI (Human Development index) [3] indicator was also introduced in order to take into account social issues.

The studied system is the production by the wet method of the green coffee variety Arabica produced in the state of Minas Gerais – Brazil and imported to Italy by Illycaffè S.p.A. The functional unit selected for this study is part (40%) of the whole seasonal production (72.000 kg) of the farm bought by Illycaffè S.p.A, that is 28.800 kg. This part corresponds to the high quality beans of the whole production as Illycaffè usually buys only the beans with major quality.

The system boundaries for the analysis takes into account the green coffee beans cultivation and their import to Italy by Illycaffè S.p.A. thus obtaining “a cradle to the gate” overview. In the study all products (like fertilizers, pesticides etc.), materials, technologies (like machineries ) and process (like nursery, tillage, harvest etc.) involved in the production of coffee beans in the “Serra do Sao Bento” farm were considered.

To assess the environmental impact the analysis was conducted using the SimaPro 7.3.3 software and IMPACT 2002+ [4] evaluation methods. In order to give more representativeness of the studied system IMPACT 2002+ was modified as in previous studies [5-6] and a new indicator, HDI (Human Development index) was also introduced in order to take into account social issues[7]. The HDI is the geometric mean of three normalized indices Life expectancy index (LEI), Education index (EI) and Income index (II) reported in the following equation:  $HDI = \sqrt[3]{(LEI \times EI \times II)}$ . HDI was also allocated taking into account the coffee gain in 20 years and the Gross Domestic Product (GDP) in Brazil.

Primary data about the inputs (i.e. materials, water and energy resources) and output (i.e. airborne and waterborn emissions and solid waste) used in this study were directly collected in Brazil, from April to September 2013, visiting the “Serra do São Bento”, a farm located in a mountain area close to Araponga, a small city in Minas Gerais. Data related to some background processes (land use, materials production, transport and machinery operations) were derived from Ecoinvent database.

### 4. Impact Assessment and concluding remarks

**A)** The analysis of the results shows that the green coffee beans cultivation and import to Italy produces a single score damage of 3.89 mPt where the coffee production phase contributes for 96.3%. With regard to the cultivation and wet processing of the coffee, the results of the study highlight that cultivation causes an environmental load of 77.51% of the total damage followed by the environmental burdens due to washing (7.82%), thermal drying (7.45%) and benefit (7.79%) phases respectively. LCIA shows that the damage to Human Health is due to the effects of inorganic emissions (62.73%) caused by Arsenic emission to soil (33.6%) due to the shedding of coffee peel in ground (Digested matter, application in agriculture), Particulates, >2.5µm, and < 10µm in air (26.29%) and Ammonia emissions in air (15.17%).

**B)**

Figure 1: Impact assessment evaluation of the green coffee beans process at the mid-point level

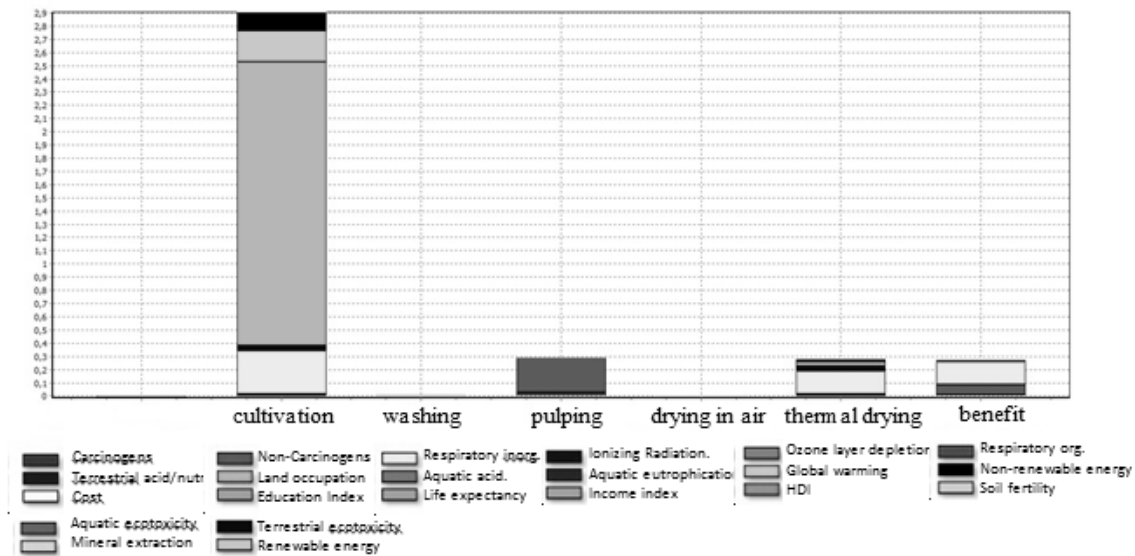

C) The damage to Climate Change is generated by the emissions of 2.6935 kg CO<sub>2</sub> (eq) due to N<sub>2</sub>O in air (53.27%) and CO<sub>2</sub> emissions in air (42.22%). The effects of land use control overall Ecosystem Quality (163.82%). In this category, the damage is mainly due to land occupation impact category (96.12%) and in particular for 57.17% to land transformation and for 38.11% to land occupation. The consumption of natural gas, oil and coal in energy supply processes affects most Non-renewable energy impact category (99.57%) that control overall the damage category Resources. The social benefits were evaluated with HDI damage category [8] and the results obtained were -0.015163 mPt thus representing an advantage of the considered system.

## 5. Conclusions

The impact assessment results reveal that the highest environmental burden is due to the land use associated to cultivation as a direct transformation from primary conditions was considered.

The new indicator, HDI (Human Development index) was introduced as Coffee production is not intended as mere exploitation of land and local producers, but as a source of wealth, culture and research development. The wet process which requires large amounts of water in washing and pulping steps (8000 l/d) should be avoided by the installation of filters that allow water recycling or less impact disposal. In addition aspiration plants to reduce particulates emissions should be considered as well as the use of biomass both as fertilizer and for power generation.

## 6. References

- [1] Coltro, L., Mourad, A.L., Oliveira, P.A.P.L.V., Baddini, J.P.O.A and Kletecke R.M., “Environmental Profile of Brazilian Green Coffee” *Int J LCA* 11 (1) (2006)16–21
- [2] Humbert, S., Loerincik, Y., Rossi, V., Margni, M., Jolliet, O., “Life cycle assessment of spray dried soluble coffee and comparison with alternatives (drip filter and capsule espresso), *Journal of Cleaner Production* 17 (2009) 1351–1358.
- [3] United Nations Development Programme (UNDP) (2013a) Human Development Report. ([http://hdr.undp.org/sites/default/files/reports/14/hdr2013\\_en\\_complete.pdf](http://hdr.undp.org/sites/default/files/reports/14/hdr2013_en_complete.pdf))
- [4] Jolliet, O., Margni, M., Charles, R., “IMPACT 2002+: A new life cycle impact assessment methodology” *Int J LCA* 8(6) (2003) 324-330.
- [5] Ferrari, A.M., Barbieri, L., Folloni, B., Neri, P., “Life cycle assessment of advertising folders” *Int J LCA* 17 (5) (2012) 625–634.
- [6] Pini, M., Ferrari, A.M., Gamberini, R., Neri, P., Rimini, B., “Life cycle assessment of a large, thin ceramic tile with advantageous technological properties” *Int J LCA* 19 (2014) 1567-1580
- [7] UNDP (2013b) Public Policies to Ensure Environmental Sustainability in Human Development, Technical notes. ([http://hdr.undp.org/sites/default/files/hdr\\_2013\\_en\\_technotes.pdf](http://hdr.undp.org/sites/default/files/hdr_2013_en_technotes.pdf))
- [8] Guagliumi, L., Master’s Thesis “Analisi di impatto ambientale con metodologia Life Cycle Assessment relativo alla produzione ed importazione di caffè brasiliano qualità Arabica: il caso Illycaffè S.p.A.” 2013 – University of Modena and Reggio Emilia - Internal Report

## The link between CSR, EMS and LCA with coffee as an example

Stefania, Furfori<sup>1</sup>; Virginia, Antonini<sup>1</sup>; Gianluca, Nardelotto<sup>1</sup>; Angela, Aiello<sup>1</sup>; Leo, Breedveld<sup>2</sup>

<sup>1</sup>Lavazza SpA, Italy

<sup>2</sup>B Srl, Italy

E-mail contact: [s.furfori@lavazza.it](mailto:s.furfori@lavazza.it)

### 1. Abstract

*In the light of a 360 degree approach to sustainable development Lavazza is engaging its efforts to ensure an integrated approach, linking Social Responsibility (CSR), Environmental Management System (EMS) and Life Cycle Assessment (LCA). Lavazza's efforts in ecodesign and LCA activities began in 2009 as part of the company's wider CSR programme, going gradually toward an integrated approach between LCA, EMS and CSR. Whilst LCA adopts a product perspective (bottom-up), providing ecodesign feedback to R&D and pointing out possible improvement options, at the same time it contributes to the other two concepts operating in a corporate perspective (top-down): the CSR strategy and the EMS strategy. The coordinated work between departments and his relative different technical corporate aspects, promotes an integrated approach to CSR, where LCA is one of the specific tools for the continuously improved of a EMS.*

### 2. Introduction

Sustainable development and minimization of environmental impacts within the coffee supply chain are of growing interest, visible by the increased application of current environmental management standards for the LCA which focus on product and corporate perspectives, or on one or plus impact categories. Lavazza's innovative approach consists in ensuring that LCA is not only used as a technical tool but is part of the overall CSR and that both are used complementarily for EMS, aligned with main standards and protocols (Table 1).

Table 1: Main standards and protocols for LCA, EMS and CSR

LCA	EMS	CSR
ISO 14040:2006	ISO 14046:2013	GRI (2005)
ISO 14044:2006	ISO 14001:2004 - ISO/ FDIS 14001: 2015	ISO14064:2012
ISO 14067:2013	EMAS	

Lavazza developed its strategies on environmental management and sustainable development, both at policy and at product level, by using LCA and CSR as two complementary approaches with different perspectives. The corporate perspective initially concentrated within the company's boundaries (gate to gate), is extended to external stakeholders (simplified cradle to grave for all products). The product perspective looks at a particular section of the company's supply chain, analyzing the life cycle stages of a single product (detailed cradle to grave). These two approaches, combined with those of the EMS, allow to structure an appropriate tool and data system for examining the environmental aspects and relative impacts of the corporate structure. Although some studies have identified weaknesses of the LCA technique, its overall evaluation is nevertheless positive [5-6]. In detail, LCA has the advantage of providing an holistic perspective, to analyze policies and practices into the boundaries of the organization (gate to gate), and beyond these (cradle to gate and gate to grave).

Although the involvement of all stakeholders might initially be more unmanageable, a holistic approach will transform barriers into mutual opportunities and thus strengthen market of all stakeholders on environmental management [1].

LCA and CSR both contribute to the continuous improvement process aimed at the minimization of environmental, social and economic impact of the company's operations, requested by an EMS. At the product level, LCA is used for ecodesign, hot spot analysis and environmental communication; whilst at the corporate level, LCA is used both strategically, to align CSR with product sustainability, and operationally, to provide a scientific basis for environmental data collection in a life cycle perspective, through tools such as the PackageExpert and the CSR tool. The link between LCA and CSR will be illustrated with coffee as an example, showing results from the tools applied.

### **3. Methods**

#### *3.1 LCA of a cup of coffee*

The following results are related to LCA for a coffee (an espresso coffee prepared with a Espresso machine and a capsule, and a moka coffee brewed with moka pot and roast&ground coffee in a pack), considering a functional unit of one cup of coffee with a volume of 30 ml along its entire life cycle (from cradle to grave). GHG emissions and other impact categories are quantified using IPCC (IPCC, 2007) and ReCiPe [2].

#### *3.2 PackageExpert and CSR Tool*

PackageExpert is a simplified ecodesign tool, which allows corporate packaging designers to develop simplified screening LCAs of different packaging solutions, enabling comparative analysis. By inserting packaging input data, such as components' materials and weights, typology of transport, manufacturing processes and end of life options [4], PackageExpert calculates the Carbon Footprint (CFP) and the Cumulative Energy Demand (CED) of the selected packaging solution. The link between PackageExpert and the product level consists in its use by packaging designers working on ecodesign. On the other hand, the tool is regularly updated and based on scientific LCA knowledge. The link with the corporate level is the possibility to apply PackageExpert to all packaging solutions performed in a company's production plant, providing aggregated data to the CSR tool.

The CSR tool is a simplified tool with a corporate approach, which allows the collection of LCA data related to the entire supply chain of all products manufactured in a certain production plant. By inputting aggregated input data, the CSR tool calculates the CFP and the CED of the entire supply chain of all products manufactured, in order to obtain relevant key environmental performance indicators. The link between CSR and the product level consists in including ecodesign activities in a corporate strategy: in this way, LCA is embedded in a context and becomes a core tool for environmental management. Operationally, LCA provides useful information that needs to be collected for the implementation of a CSR strategy.

#### *3.3 EMS*

Currently new systems of corporate environmental management promote the life cycle thinking. This approach is based on the circular economy and the principle of responsibility.



Characterized by a long-term perspective on environment management, impacts not directly related to the production process and the effect of company choices are evaluated. In fact the company can help reduce them, even in absence of direct managerial responsibility. The management company is expanding its focus from local to the product system with the involvement of all stakeholders. Under the pressure of this new perspective introduced by ISO/FDIS 14001:2015, the application of LCA as a tool for identification and assessment of environmental aspects in EMS is a logical result. The extent of operational control to the entire value chain and the LCA application allow to identifying and capturing the ecological burden, related to both indirect, as well as direct aspect [5].

## 4. Results

### 4.1 LCA of a cup of coffee (espresso coffee and moka coffee)

The absolute results of two studies not are comparable for the difference in coffee beverages and in the systems to brewing, but it is possible to observe a common trend in both studies. The results in fact show that the most significant impacts are generated during the upstream processes (55%-82%), while a significant remaining part is generated during the downstream processes (16%-42%). The environmental hot spots are the green coffee cultivation (32%-70%), coffee consumption (17%-28%) and packaging (3%-19%). Overall, the LCA results appear to be consistent with other studies published on coffee [7- 8].

### 4.2 PackageExpert and CSR tool

The CSR tool enables aggregation of LCA data into environmental performance indicators at the corporate level. Figure 1 shows the results of the CSR tool applied to the entire supply chain of Lavazza Corporate, expressed in CO<sub>2</sub> eq (CFP) per life cycle stage. In a simplified way, based on aggregated LCA data, material flows and production volumes, the CSR tool evaluates the life cycle stages (excluding the use phase) of all main products manufactured at the production plants. In other words, it represents an aggregation of many product levels into the corporate level. The emission index is calculated on the total annual coffee packed from the corporate plants, while the single contributions of emission are the cultivation of green coffee, the consumptions of the plants for his manufacturing and of the offices not for direct production, the total of packaging used (calculated with Package Expert), the distribution of final products and the coffee waste treatment after use.

Figure 1. Results of the CSR tool for the entire supply chain

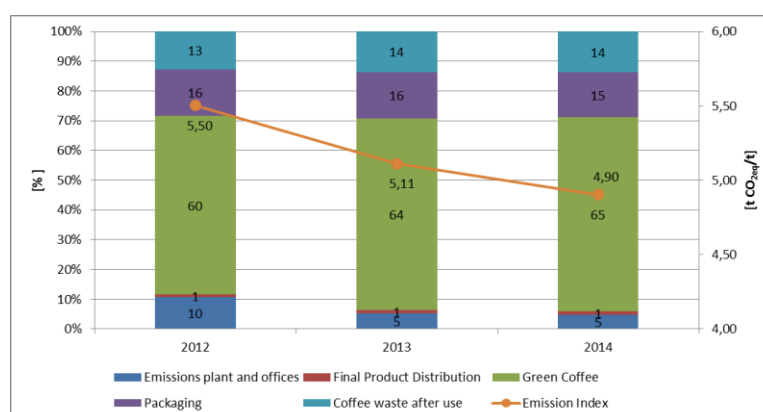

## 5. Discussion

Environmental hot spots identified with coffee LCA (e.g. over upstream processes) emphasizes the need to view the environmental performance of coffee in a life cycle perspective, as required by current standard about the EMS. LCA is used strategically to align CSR with product sustainability, and, operationally, to provide a scientific basis for environmental data collection in a life cycle perspective.

Moreover, the continuous updating and use of the corporate tools, Package Expert and therefore the CSR Tool, allows to have readily useful results for any strategic and operational decisions.

## 6. Conclusion

In conclusion, whilst an integrated LCA and CSR approach can seem more time consuming and complex to manage in terms of costs as well as unification of data, at the same time it provides a distinct advantage in terms of holistic approach, data collection, optimization and verification as well as methodology. Further, it provides an unique opportunity to achieve maximum alignment of product and corporate strategies as well as an effective stakeholder engagement.

Future work on the integrated LCA and CSR approach will focus on the improvement of the interaction between the two concepts, both at the strategic and the operational level, enhancing the information exchange between tools and systems. The obtained experience will be used to further implement this integrated approach to the entire organization of Lavazza, both at all production facilities and along the entire coffee supply chain.

The planned changes to ISO/FDIS 14001:2015 with regard to the use of LCT and eco-design should be seen as a a real opportunity to increase interest in eco-design tools amongst the environmental managers responsible for the environmental management systems within their organisations [9].

## 7. References

- [1] Furfori F. et.al. (2012). LCA of one cup of espresso coffee: how to collect and validate LCA data along the coffee supply chain. Poster 8th International Conference on "Life Cycle Assessment in the Agri-Food Sector" LCA Food 2012.
- [2] Goedkoop M.J., Heijungs R., Huijbregts M., De Schryver A., Struijs J., Van Zelm R. (2012). ReCiPe 2008, A life cycle impact assessment method which comprises harmonised category indicators at the midpoint and the endpoint level. First edition (revised) Report I: Characterisation; July 2012 ([www.lcia-recipe.net](http://www.lcia-recipe.net)).
- [3] Guinée, 2002: CML handbook LCA
- [4] ISPRA (2012). Rapporto Rifiuti Urbani 2012. ([www.isprambiente.gov.it](http://www.isprambiente.gov.it)).
- [5] Lewandowska A. (2011). Environmental life cycle assessment as a tool for identification and assessment of environmental aspects in environmental management system (EMS) part 1: methodology. *Int J of Life Cycle Assess* 16:178-186.
- [6] Matuszak-Flejszman A. (2007). Environmental management system in organization. Publishing house of Poznan University of Economics; Poznan; Poland, Nemecek T., Kägi T., 2007: Life cycle inventories of agricultural production systems. Data v2.0 Ecoinvent report No. 15a.
- [7] Humbert S., Loerincik Y., Rossi V., Margni M., Jolliet O., (2009). Life cycle assessment of spray dried soluble coffee and comparison with alternatives (drip filter and capsule espresso). *Journal of Cleaner Production* 17: 1351–1358
- [8] TCHIBO: Case Study documentation undertaken within the PCF Pilot Project Germany, 2008.
- [9] Lewandowska A., Matuszak-Flejszman A. (2014). Eco-design as a normative element of Environmental Management Systems—the context of the revised ISO 14001:2015. *Int J Life Cycle Assess* (2014) 19:1794–1798

# **Sustainability and performance design of open loop recycling strategies in the production of innovative building materials**

Alessandra Pierucci

DICATECh, Dipartimento di Ingegneria Civile, Ambientale, del Territorio, Edile e di Chimica,  
Politecnico di Bari, Via Orabona 4, 70125, Bari

E-mail contact: [alessandra.pierucci@poliba.it](mailto:alessandra.pierucci@poliba.it)

## **1. Abstract**

*The goal of the research is the assessment of the impacts associated with the production of lightweight concretes containing recycled EPS, resulting from pre-consumer waste grinding activities. For this purpose, the performance mix design of ten different types of recycled mixtures has been developed, for which several performance attributes (workability, mechanical resistance, thermal insulation) have been tested. The work deepens, through LCA evaluations, the analysis of the critical issues related to the production stage of recycled EPS concretes, highlighting the potential benefits associated with the adoption of open-loop recycling strategies.*

## **2. Introduction**

Within the research of construction products fully compliant with the European sustainability requirements provided for the construction industry [1], the use of waste coming from the manufacturing sector allows the minimization of the impacts associated with materials production and treatment at the end of life. Referring, in particular, to the optimization of the environmental profile of lightweight concretes, several research have analyzed the potential benefits associated with the addition of polystyrene by-products to the mixture, especially from a thermal insulation point of view [2,3]. The study is part of the research project entitled HPWalls, High Performance Wall System, which have tested an innovative bearing wall composed of a double reinforced concrete layer, interior concrete casting and external insulation in EPS panels; in this context, the main goal of this research is the LCA evaluation of the environmental impact of cement mixtures (to be used in the innovative wall's inner core) containing recycled scraps coming from the production of expanded polystyrene (EPS) panels. All the wall components belong to the existing manufacturing lines of a local firm (partner of the HPWalls project), located in Fasano (Br) and specialized in the production of materials and envelope solutions for the building sector.

## **3. Materials and Methods**

### *3.1 Goal and scope definition, Functional unit*

The assessment of the impacts of the mixtures production was developed in accordance with technical standards in the field (ISO 14040, ISO 14044:2006). The perspective of the study is "from cradle to gate" and the calculations were performed using the software SimaPro 8.0.4, IMPACT 2002+ method. The study aims to develop the analysis of the impacts of different lightweight concrete with the addition of EPS grains resulting from the grinding of scraps of the polystyrene slabs production. As regards the mix design phase, eleven mixtures have been conceived (Tab. 1) in which, without changing the w/c ratio, a replacement of the fine aggregate (sand) granulometry with an equal volume of recycled EPS has been implemented.

The sampling was carried out in order to test which mixture results suitable for the production of lightweight concrete in accordance with national regulation and technical standards [4].

Table 1: Mix design specification for the functional unit,  $1m^3$  of lightweight concrete

			EPS			SAND
Replacement of the entire granulometry	1	CO				$V_s$
	2	CE_100	$V_s$			
	3	CE_25	25% $V_s$			75% $V_s$
	4	CE_75	75% $V_s$			25% $V_s$
	5	CE_50	50% $V_s$			50% $V_s$
Replacement of granulometric fractions	6	CEp_1-2	$V_s$ (1-2)			$V_s - V_s$ (1-2)
	7	CEp_2-4		$V_s$ (2-4)		$V_s - V_s$ (2-4)
	8	CEp_4-8			$V_s$ (4-8)	$V_s - V_s$ (4-8)
	9	CEp_1-4	$V_s$ (1-2)+(2-4)			$V_s - [V_s$ (1-2)+ $V_s$ (2-4)]
	10	CEp_2-8		$V_s$ (2-4)+(4-8)		$V_s - [V_s$ (2-4)+ $V_s$ (4-8)]
	11	CEp-1-8	$V_s$ (1-2)+(2-4)+(4-8)			$V_s - [V_s$ (1-2)+ $V_s$ (2-4)+ $V_s$ (4-8)]

### 3.2 System boundaries, data quality and allocation specifications

For the LCA analysis of lightweight concrete, the flow chart shown in Fig. 1 was used. LCI flows have been developed on primary data regarding EPS products, by-products and co-products manufacturing activities; these data have been collected by means of questionnaires and interviews with the technical staff of the company. For the other materials secondary data were employed. For energy consumption during the various manufacturing processes, the mix coming from the grid and from two photovoltaic systems, installed in the firm, was taken into account.

Figure 1: Inventory flow scheme

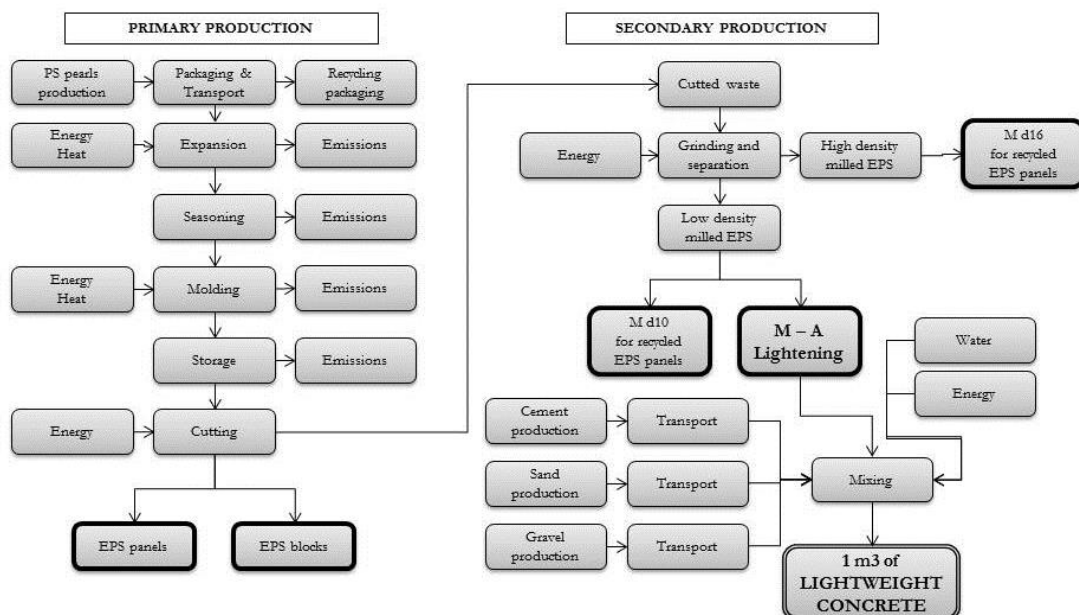

Analyzing in detail the Ferramati case it was found that the industrial process generates in output two products, EPS panels and blocks, and three co-products, resulting from grinding of scraps, that are: “M-A” - usable as a lightening material -, “Md10” and “Md16” - reused in the production of regenerated EPS sheets (respectively having density equal to 10 and 16 kg/m<sup>3</sup>):

All products and co-products are sold from the company; therefore, in order to allocate impacts related to the production stage and to the subsequent use of by-products, a cascade approach [5] was used for the the impact evaluation of the milled EPS (M-A one, to be used for the production of cement mixtures) allocating it on the basis of the production cost driver.

#### 4. Life Cycle Assessment results

The Figure 2 shows the results of the LCA comparative evaluation of the 11 mixtures, in terms of midpoint category indicators, evaluated in accordance with IMPACT 2002+ (version 2.12) methodology. The analysis confirm that in all mix design cases, the concrete with recycled EPS generates an overall lower impact. In particular, the mixture that contributes most to this reduction is the CE\_100 in which it is provided the complete replacement of the fine aggregate with EPS grains. In general, this advantage is most evident for that mixtures in which the entire sand granulometric distribution was replaced; in the second sampling the partially replacement of the granulometric distribution generates reductions ranging from a maximum of -29.37% (CEp\_1-8), and a minimum of -9.49% (CEp\_1-2). These results are justified, on the one hand, by the different impact achievable for the use of recycled EPS grains (84.4% less than the virgin pearls impact) and, secondly, by the savings of sand achieved in the various mixtures.

Figure 2 : Life Cycle Assessment results

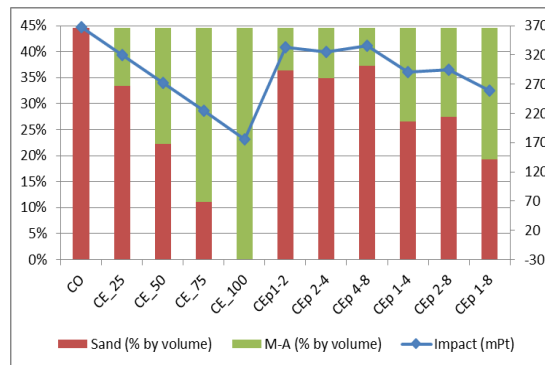
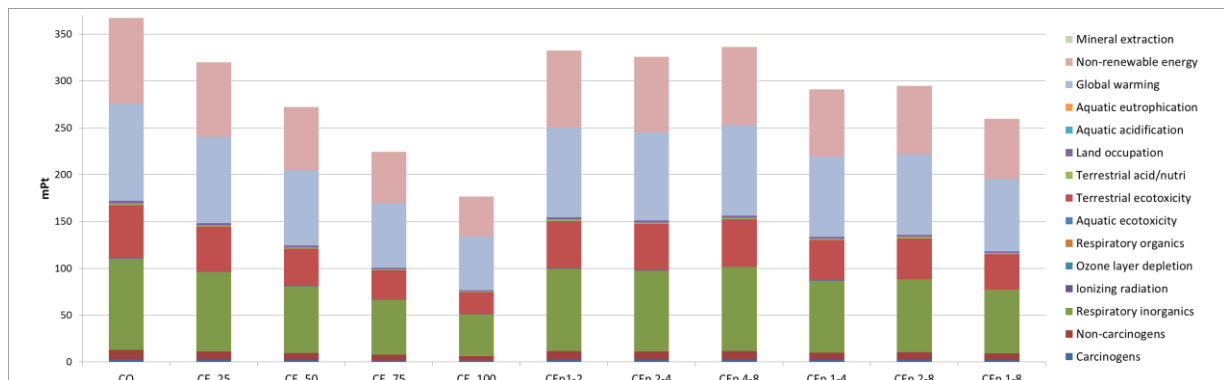

Figure 3: Impacts in relation to the percentages by volume of sand and recycled EPS



## 5. Conclusion

The LCA has estimated the environmental impacts of ten lightweight concrete mixtures, composed of sand, gravel, water, cement and recycled pre-consumer EPS grains, produced by a local firm. The results confirm that the adoption of open-loop recycling strategies can ensure a considerable reduction of the production impacts, optimizing the management of manufacturing waste. Additional studies carried on such mixtures have confirmed, for some of them, the achievement of mechanical strength characteristics suitable to seismic action, good workability and sound insulation properties. These outcomes will allow the investigation of other attributes that could improve the use of those mix, in various life cycles and context of application.

## 6. References

- [1] Regulation (EU) n. 305/2011 of the European Parliament and of the Council.
- [2] Kan, A., Demirbog, R., 'A novel material for lightweight concrete production', *Cement & Concrete Composites* 31 (2009) 489–495.
- [3] Miled, K., Sab, K. Le Roy, R., 'Particle size effect on EPS lightweight concrete compressive strength: Experimental investigation and modelling', *Mechanics of Materials* 39 (2007) 222–240.
- [4] UNI 7548-1, Calcestruzzo leggero con argilla e scisti espansi. Definizione e classificazione
- [5] Vogtländer, J.G., Brezet, H.C., Hendriks, C.F., 'Allocation in Recycling Systems. An Integrated Model for the Analyses of Environmental Impact and Market Value', *Int J LCA* 6 (2001) 344-355.

# **A tool for the sustainability assessment of transformation activities of buildings**

*Alessandra Pierucci, Guido R. Dell'Oso*

DICATECh, Politecnico di Bari, Via Orabona 4, 70125, Bari  
E-mail contact: [alessandra.pierucci@poliba.it](mailto:alessandra.pierucci@poliba.it), [guidoraffaele.delloso@poliba.it](mailto:guidoraffaele.delloso@poliba.it)

## **1. Abstract**

*The aim of the research is the identification of a tool, defined “Index of Sustainable Transformability”, that expresses, through Life Cycle Assessment evaluations, the adaptability level of buildings towards future transformations and the reusability potential of its components. The work tested this tool in a case study, developing a comparative analysis of the impacts of a residential building made with two different manufacturing technologies (a dry layered and a traditional one) for which a reconfiguration has been considered 30 years after its construction.*

## **2. Introduction**

The social-demographic change, in progress for some years, has caused, together with other factors typical of regulatory and technology developments, the inadequacy of the housing stock; moreover, with respect to the heterogeneity and variability of the users' needs in the time, this has generated an acceleration of reconfiguration/transformation timeframes of buildings. These issues have pushed the research of new design solutions, methodological approaches and intervention strategies that could improve the adaptability of buildings and limit the environmental impact due to the early disposal of materials and components (with respect to its durability) and to the increase of waste production. In such sense, the use of a modular, prefabricated and disassemblable design strategies, can contribute to maximize the reuse of materials and components reconfigured during the time, improving the environmental profile of the whole building [1, 2].

## **3. LCA and Index of Sustainable Transformability**

LCA of the reusability potential of building components coming from reconfiguration activities may allow to introduce a different impacts allocation methodology: this is related to the performance capability of the residual product, to the duration of its life cycle and of all the potential future application [3]. This consents to specify further the results based on attributional approaches, that assign all impacts to the first useful life, or on cut-off methods that disconnect impacts attributable to multiple life cycles [4]. The study aims to show the contribution of a new approach that could represent the capability of a building to respond, in a sustainable way, to reconfiguration activities over the time and, in particular, to enhance the remaining performance capability of the removed/replaced components through their reuse in further lifecycles. This method is based on the quantification of the building transformation impacts which are considered as the sum of all the impacts due to the intervention (i.e. energy for disassembling, new resources, transport, scraps), less the environmental burdens for the production, construction and disposal of the reusable elements, allocated both from the physical point of view (quantity, by weight, of reusable materials with respect to the built amount) and temporal one (comparing the remaining performance capacity of the reusable product to its overall durability).

The hypothesis, that is further under study by the authors, defines the influence of transformation activity on the whole life cycle impact and explain the building adaptability, due, therefore, to lower percentages of such actions on the total impacts.

#### 4. The case study

The case study analyzes a single-storey residential building made with different manufacturing technologies. The first one (T01) has a laminated wood structure and dry assembled external walls composed of modular OSB panels, wood fiber and fiber boards. The second (T02), similar in size and transmittance of the external envelope, has a reinforced concrete structure and external walls made of hollow bricks and insulation polyurethane foam. The evaluation is referred to a total lifecycle of 100 years. Within this timeframe it was assumed that, after 30 years since the building construction, an intervention of reconfiguration takes place, in order to obtain a contraction of a third of the useful area.

*Figure 1: The building T01 before and after the reconfiguration*



This hypothesis aims to investigate the adaptability of the building to the reduction of the envelope areas and of the interior partitions; likewise the study, seen in comparative perspective between the two classes of building technologies, wants to explicit the relationship between the reuse potential of the different systems, the times of use, the assembly/disassembly method as well as the durability of the various components. The goal is the comparison of the environmental impacts of the two buildings in their entire life cycle in a "from cradle to grave" perspective, using the software SimaPro 8.0.4, IMPACT2002+ method. The attributional approach was adopted for the construction of the inventory flows and the impacts evaluation.

#### 5. Life Cycle Assessment results and calculation of the Index of Sustainable Transformability

The following figure shows the results of the LCA evaluations, developed assuming the whole building as functional unit, in the case T01 (left column) and T02 (right column).



Figure 2: Comparison of the impacts of the two cases in the 100 years lifecycle

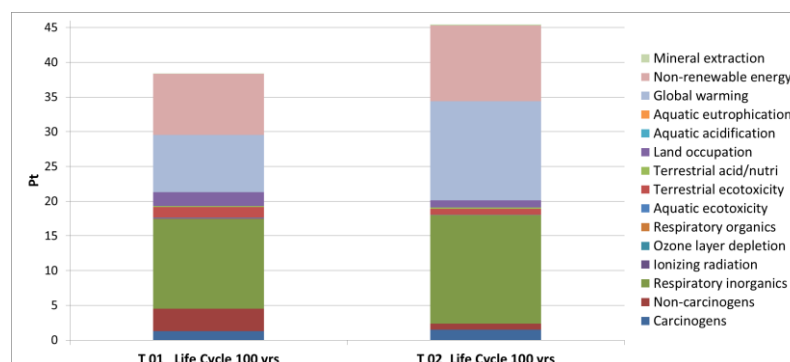

In the first scenario, the overall environmental impact of the building is 38.39 Ecopoints for the T01 case (wooden one) and 48.33 for T02 (brick one). In particular, the comparison of the two constructive typologies shows the different incidence of the various life stages on the overall impact: for the first the impact of the construction phase is equal to more than half of the total (51.4 %), followed by the maintenance (43.8%) and the reconfiguration (5.8%). For the second the impacts for the construction and maintenance activities are comparable (respectively 42.4% and 48.5% of the total), followed by the environmental burdens due to reconfiguration activities, 35% higher than those of the wood case. With reference to the end of life, the environmental behavior of the two building technologies is very different, according to the adopted system model: in the case of the dry structure, in fact, the complete disassembly of the parts generates higher recyclability opportunity at its end of life; on the other hand, in the T02 case this scenario is less applicable, due to the difficulties in implementing a selective disassembly of the components.

In order to make explicit the different reusability potential of the involved components, from an environmental point of view, it was carried out the calculation the Index of Sustainable Transformability, obtained from the ratio between the transformation impacts, as defined in par. 2, and the impact of the building in its entire life cycle. This study shows that  $I_{ts} = 0.50\%$  for the case T01 and  $I_{ts} = 9.10\%$  for the case T02, confirming that the first construction technology is more flexible, from the environmental and constructive point of view, towards a transformation of its original layout over time. It's evident that the incidence of reconfiguration activities in buildings designed without flexibility attributes (such as T02) does not allow to estimate a reuse of components that are removed or demolished, causing an increased incidence of these actions, the loss of the residual performance capability of such products and the increase of final waste flows.

Figure 3: The different impact of reconfiguration activities in in the adopted approach

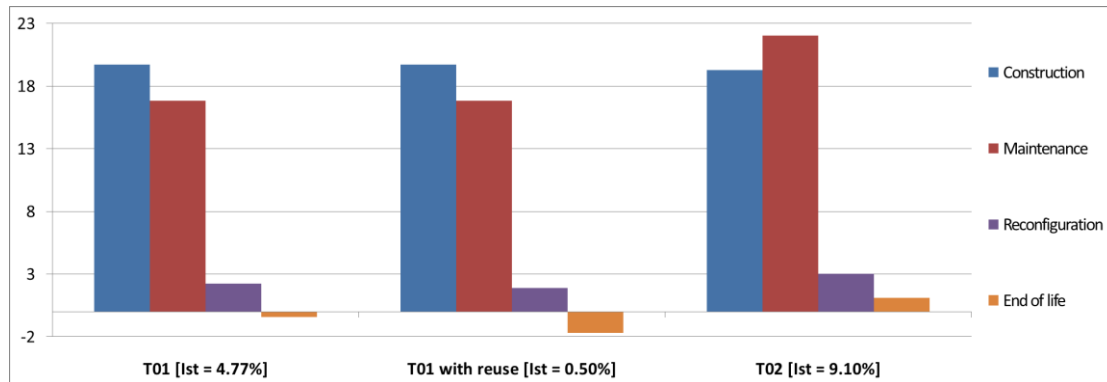

## 6. Conclusion

The research has tested the adoption of an indicator for the quantification of the sustainability level of buildings and the reusability potential of the components in relation to its durability, the assembly techniques and the use. It represents a helpful orientation tool to harmonize environmental investment with the times of use of building elements, in order to extend the useful life of the components in multiple cycles and, so, mitigate its impact over the time.

## 8. References

- [1] Lavagna, M., Arena, M., Dotelli, G., Zanchi, M., ‘The temporary structures for Expo Milan 2015: environmental assessment and solutions for the end of life management’, *TECHNE* 7, (2014)171 – 177.
- [2] Aye, L., Ngo, T., Crawford, R.H., Gammampila, R., Mendis, P., ‘Life cycle greenhouse gas emissions and energy analysis of prefabricated reusable building modules’, *Energy and Buildings* 47, (2012) 159–168.
- [3] Dell’Osso, G.R., Pierucci, A., Thormark, C., ‘LCA evaluations applied to DfD building strategies’, *Proceedings of 5th Dubrovnik Conference on sustainable development of Energy, Water and Environment System*, October, 2009 (Printera Grupa, Zagreb).
- [4] Nicholson, A.L., et al., ‘End-of-life LCA allocation methods: Open loop recycling impacts on robustness of material selection decisions’, *Proceedings of IEEE International Symposium on Sustainable Systems and Technology*, 2009.

## LCA of clean technologies in food value chains of emerging economies

Eymann Lea<sup>1</sup>, Stucki Matthias<sup>1</sup>, König Alex<sup>1</sup>, Scharfy Deborah<sup>1</sup>, von Blottnitz Harro<sup>2</sup>

<sup>1</sup>Zurich University of Applied Sciences, Institute of Natural Resources Sciences, 8820 Wädenswil, Switzerland

<sup>2</sup>University of Cape Town, Rondebosch 7701, South Africa

E-mail contact: lea.eymann@zhaw.ch

### 1. Abstract

*Up to one third of the environmental impact of private consumption is related to the provision of food. In an ongoing Swiss-South African research project, the potential of clean technologies to mitigate these impacts is analysed within the context of South African food value chains. First results indicate that technologies reducing the use of non-renewable electricity are particularly effective.*

### 2. Introduction

Food and beverage production cause 20%-30% of the various environmental impacts of private consumption in Europe [1]. Along the entire food value chain, clean technologies have the potential to reduce the demand for natural resources, the use of energy and the pollution of water, air and soil. In order to make science-based decisions concerning the implementation of clean technologies in the life cycle of agri-food products, it is essential to identify environmental hotspots where mitigation via cleantech is particularly relevant. Various studies have analysed the environmental impacts of food products by applying a Life Cycle Assessment (LCA) [2]. However, most of these studies focus on food production in Europe or other industrialized countries, whereas emerging economies play an increasingly important role for global food production [3]. The potential of clean technologies to mitigate the environmental impacts of South African fruits, dairy products, pork and maize was analysed in a joint research project of the Zurich University of Applied Sciences and the University of Cape Town. This publication shows initial outcomes for pome fruit, stone fruit, citrus fruit and table grape production in South Africa and discusses to what degree the results can be transferred to other emerging economies.

### 3. Methodology

In order to quantify the potential of clean technologies to mitigate environmental impacts in the South African food value chain, the existing situation was analysed with a Life Cycle Assessment according to the ISO standard 14040 [4]. Subsequently, clean technologies were defined for each value chain and their potential to reduce the life cycle environmental impact of food products was quantified. In this paper we show selected results for the impact categories climate change [5], human toxicity, freshwater eutrophication and acidification [6]. The Life Cycle Inventories of fruits are primarily based on the data base of the South African Fruit and Wine Industry Initiative called Confronting Climate Change (CCC). CCC provided data from 40-70 producers, which cover approximately 13% of stone fruit and table grape production, 30% of pome fruit production and <1% of citrus production in South Africa. The LCA includes fruit production, packaging and cold storage. The reference flow is 1 kg of a defined fruit commodity ready for export at the cold storage. For the fruit value chain the following mitigation scenarios have been analysed: (1) partial switch from conventional electricity mix to solar power (30% substitution at farm and packhouse, 15%

substitution at cold storage); (2) reduced electricity demand of irrigation pumps (-34%) through the implementation of variable speed drives (VSD); (3) use of reusable plastic transport boxes instead of carton packaging materials; (4) 50% substitution of N-fertilizers by compost; (5) reduction of pesticide use by the use of electrostatic spray technology [7].

#### 4. Results

The electricity consumption throughout the food production and processing significantly contributes to the environmental impact of fruit value chains. The electricity demand is relevant for both on-farm and post-farm processes. At the farm-level, the electricity and infrastructure demand for irrigation is associated with the highest impact in terms of greenhouse gas emissions. Downstream processes at the packhouse and the cold storage as well as domestic transport account for 34%-56% of the GWP of fruits (Figure 1).

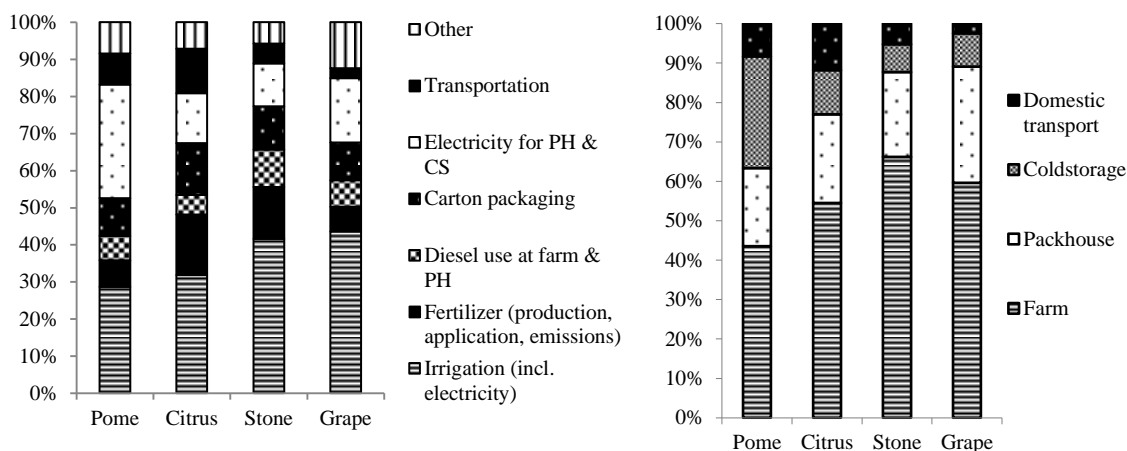

Figure 1: Contribution of processes (left) and production stages (right) to the Global Warming Potential of South African fruits. PH: Packhouse; CS: Cold storage

The electricity consumption throughout the food production and processing is also a major contributor to the acidification potential, the freshwater eutrophication and the human toxicity. Accordingly, irrigation and electricity consuming processes at the packhouse and the coldstorage dominate the result (figure 2) [7].

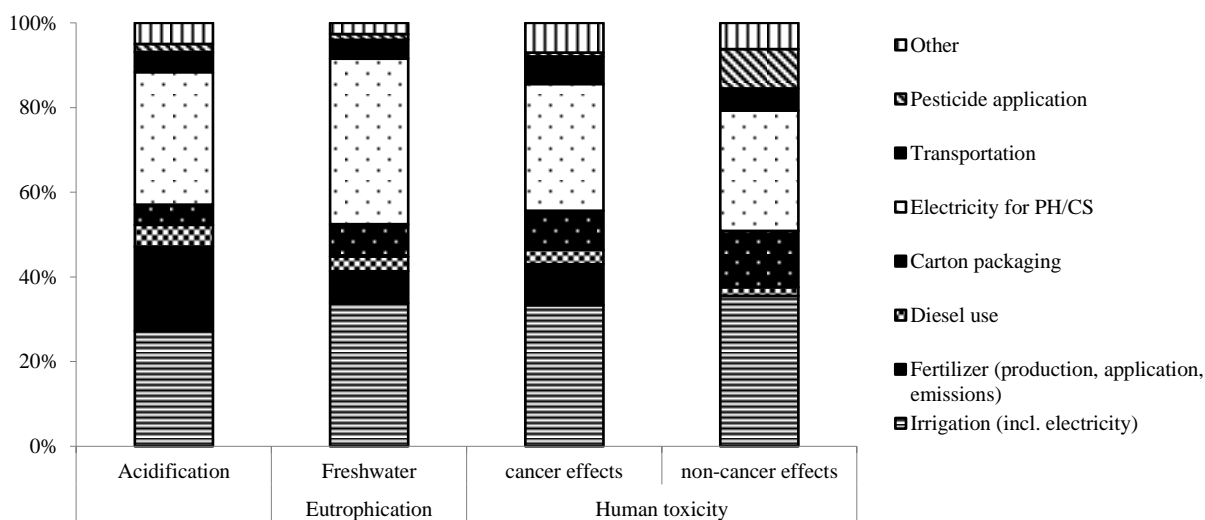

Figure 2: Acidification potential, freshwater eutrophication and human toxicity of South African pome fruits

Since the consumption of national grid electricity plays a major role in the life cycle of South African fruit value chains, the highest environmental impact mitigation potential can be obtained from technologies which reduce the non-renewable electricity demand. Accordingly, the mitigation scenario 1 (use of solar power) resulted in the highest improvement potential for most indicators (-11% to -18% for pome fruits). The implementation of VSD (mitigation scenario 2) leads to a reduced electricity demand for pumping. Thereby the global warming potential and the cumulative energy demand of pome fruits can be reduced by 8%. The mitigation potential of scenario 3 (reusable packaging) and scenario 5 (electrostatic pesticide spraying) is relatively small. The use of compost in the pome fruit production (mitigation scenario 4) leads on the one hand to savings of -6% to -11% for the global warming potential, the acidification potential and the carcinogenic human health effects. On the other hand, an increased risk of freshwater eutrophication and non-carcinogenic human toxicity impacts might be expected due to nutrient and heavy metal leaching [7].

## 5. Discussion and conclusion

The substantial contribution of electricity to the environmental impact of South African fruits can mainly be attributed to two issues: First, coal-generated electricity accounts for approximately 90% of the South African electricity mix [8]. Electricity production is therefore associated with a broad range of environmental issues. Second, approximately 30% of South Africa's crops are produced under irrigation [9] and nearly two-thirds of South Africa's surface water is used by irrigated agriculture [10]. Although irrigation has a positive effect on the yield, it may contribute to local water scarcity and is related with a high electricity demand for water pumping.

Due to the high importance of coal power in South African food value chains, clean technologies which reduce the non-renewable electricity demand have the highest potential to mitigate environmental impacts. Like South Africa, also other emerging economies such as China and India rely heavily on coal and other fossil fuels [11]. Moreover, the percentage of irrigated area is typically high in emerging economies (especially in Asia) due to climate conditions and extensive areas of land used for agriculture [12]. Hence, reducing the fossil electricity demand by implementing clean technologies in the food value chain of emerging economies generally has a substantial environmental impact mitigation potential.

## 6. References

- [1] Tukker, A., Huppes, G., Guinée, J., Heijungs, R., Koning, A. d., Oers, L. v., Suh, S., Geerken, T., Holderbeke, M. V., Jansen, B., & Nielsen, P. (2006). Environmental Impact of Products (EIPRO): Analysis of the life cycle environmental impacts related to the final consumption of the EU-25.
- [2] Notarnicola, B., Salomone, R., Petti, L., Renzulli, P. A., Roma, R., & Gerutti, A. K. (Eds.). (2015). Life Cycle Assessment in the Agri-food Sector. Case Studies, Methodological Issues and Best Practices Springer International Publishing. doi: 10.1007/978-3-319-11940-3
- [3] Fan, S., & Brzeska, J. (2010). The Role of Emerging Countries in Global Food Security. No. IFPRI Policy Brief 15 International Food Policy Research Institute.
- [4] International Organization for Standardization. (2006). Environmental management - Life cycle assessment - Principles and framework. ISO 14040:2006; Second Edition 2006-06.
- [5] IPCC. (2013). Climate Change 2013: The Physical Science Basis. Contribution of Working Group I to the Fifth Assessment Report of the Intergovernmental Panel on Climate Change. Cambridge University Press.

- [6] Hauschild, M., Goedkoop, M., Guinée, J., Heijungs, R., Huijbregts, M. A. J., Joliet, O., Margni, M., & De Schryver, A. (2011). Recommendations for Life Cycle Impact Assessment in the European context - based on existing environmental impact assessment models and factors. European Commission - DG Joint Research Centre, JRC, Institute for Environment and Sustainability (IES).
- [7] König, A. (2015). Environmental Hotspots and the Potential of Clean Technologies in the South African Fruit Supply Chain. (Unpublished Master Thesis). Zurich University of Applied Sciences, Institute of Natural Resource Sciences, Wädenswil, Switzerland.
- [8] Subramoney, J., van Wyk, J., Dithupe, M., Molapo, A., Mahlangu, N., & Morumudi, R. (2010). Digest of South African Energy Statistics 2009. Pretoria, South Africa: Department of Energy.
- [9] Goldblatt, A. (2011). Agriculture Facts & Trends - South Africa. WWF.
- [10] Colvin, C. (2015). Water. In I. Kotze, & M. Rose (Eds.), *Farming Facts and Futures: Reconnecting South Africa's food systems to its ecosystems*.pp. 20-27. Cape Town, South Africa. WWF.
- [11] Asif, M., & Muneer, T. (2007). Energy supply, its demand and security issues for developed and emerging economies. *Renewable and Sustainable Energy Reviews*, 11, 1388-1413.
- [12] Douben, N., & Ratnayake, R. M. W. (2006). Characteristic data on river floods and flooding; facts and figures. In J. van Alphen, E. van Beek & M. Taal (Eds.), *Floods, from Defence to Management: Symposium Proceedings of the 3rd International Symposium on Flood Defence*.pp. 19-35

# Life Cycle Assessment of Food Smoking Technologies

Sergiy Smetana<sup>1,2</sup>, Stefan Toepfl, Alexander Mathys<sup>1</sup>, Karl Bärwinkel<sup>3</sup>, Stefanie Knaup<sup>4</sup> and Volker Heinz<sup>1</sup>

<sup>1</sup>German Institute of Food Technologies (DIL e.V.), Prof.-von-Klitzing-Str. 7, D-49610 Quakenbrück, Germany

<sup>2</sup>ISPA, University of Vechta, Driverstraße 22, 49377 Vechta, Germany

<sup>3</sup>Red Arrow Handels-GmbH, Hanna-Kunath-Str. 25, D-28199 Bremen, Germany

<sup>4</sup>August Strothlücke GmbH & Co. KG, Berensweg 22, 33415 Verl, Germany

E-mail contact: [s.smetana@dil-ev.de](mailto:s.smetana@dil-ev.de)

## 1. Abstract

This Life Cycle Assessment (LCA) of three food smoking scenarios was aimed to estimate the environmental impact of traditional and innovative food smoking technologies to indicate their comparative advantages and possibilities for improvement. With the functional unit of 1 tonne raw sausages cold smoking and system boundaries from cradle-to-grave, the worst case scenario (friction smoking) required a lot of energy for smoke generation, which resulted in high impacts (247.83 – 284.21 kg CO<sub>2</sub> eq.; 1.1 – 2.47 m<sup>2</sup> of land; 4522 – 5418 MJ). “CleanSmoke” demonstrated the best performance (126.15 – 141.05 kg CO<sub>2</sub> eq.; 0.7 – 1.52 m<sup>2</sup> of land; 2110 – 2523 MJ) due to the decreased use of energy for smoke generation. Despite extended life cycle chain and transportation distances, “CleanSmoke” was more environmentally beneficial provided innovative smoke production equipment was used.

## 2. Introduction

Smoking of food products has been practiced for ages for its preservation qualities. Today, color and flavor development are the major reasons for food smoking. Traditional smoking is performed by exposing foods to smoke from wood burning or smoldering. The thermal decomposition of wood results in anhydroglucose, carbonyl-containing compounds, acetic acid and phenolic compounds, which also act as outputs to the environment [1-4]. More innovative, purified primary smoke products (“CleanSmoke”) are produced by controlled pyrolysis of wood under limited oxygen and condensation of the smoke by cooling with the aid of water or oil. The solution contains a complex mixture of compounds which is further processed and conditioned by purification, concentration or drying.

Innovative smoking methods allow elimination of waste impacts at the food smoking site, however they require higher energy application (friction smoking) or extended transportation of the application substance (CleanSmoke). Therefore, environmental benefits of one smoking technology over another are not obvious if the complete supply chains of smoking agents are considered. Previous studies have indicated the potential beneficial impact of innovative food smoking technologies [5-6]. Moreover, as most studies note that processing is responsible for a minor impact in supply chain [7-9], the complete environmental analysis of purified primary smoke product life cycle was not previously performed and published.

Table 1: main LCI inputs of smoking technologies application (per 1 tonne of raw sausages); minor inputs are excluded

Input	Unit	Scenario		
		Friction (1)	Smoldering (2)	CleanSmoke (3)
<b>Trees growing and transportation</b>				
Land use	m <sup>2</sup>	65.1625	375.9375	62.556
Fuel for harvesting	MJ	0.044	0.255	0.141
Wood transportation	tkm	0.1625	0.9375	0.156
<b>Smoking media preparation</b>				
Electricity	kWh	0.1721	0.6621	Saw dust 0.1652; CleanSmoke 0.001038
Natural gas	kWh	-	-	1.9674
Water	m <sup>3</sup>	-	-	0.000327489
Electricity (heat) drying	kWh	0.134 (1.203)	0.7734 (6.94)	0.1287 (1.1548)
Transportation - CleanSmoke	tkm	Poles 0.4875	Chips 4.6875	Saw dust 0.936; Truck 3.36; Ship 13.46
Packaging	kg	-	0.0167 (LLDPE)	0.00245 (HDPE); 0.0062 (steel); 0.0023 (wood)
Wastes and by-products	kg	-	-	0.832 (ash); 0.416 (tar)
Washing detergent	l	-	-	0.37
<b>Smoke generation and smoke chambers operation</b>				
Electricity from the grid	kWh	29.43	18.82	14.79
Electricity from natural gas burning	kWh	294.27	188.18	147.86
Water for cleaning	m <sup>3</sup>	0.05977	0.3013	0.03665
Detergent for cleaning	l	0.37	1.79	0.34
Wastes generated	kg	0.83 (ash); 0.42 (tar)	4.8 (ash); 2.4 (tar)	-

### 3. Goal and scope of the study

The goal of this study was to perform the comparative LCA utilizing the most current research and literature data on production practices, processing, and disposal of food smoking technology wastes. The comparison of three food smoking technologies was set as the background for the assessment: (1) Friction – smoke generation via wood pole friction against rotating cogwheel; (2) Smoldering – pyrolysis of wood chips; (3) CleanSmoke – atomization of purified natural smoke condensate.

The functional unit (FU) was defined as “cold smoking of 1 tonne of raw sausages”. FU determined that the quality of sausages enrichment with smoked flavor substances had to be at the same level for all three scenarios (1-3). It was achieved by holding the sausages for the same duration in similar smoking conditions (which does not exclude the differences in the smoke generation time for different technologies). System boundaries for the technologies include smoking media production (trees growing, cutting, chopping and sawing), smoking media transportation, smoke generation, sausage smoking, cleaning and waste treatment. Meat production was not included in this LCA (similar for all scenarios).



The smoking house was based in Verl, Germany; wood material was transported for 150-250 km from growing areas (1-2); CleanSmoke (3) was manufactured in Manitowoc and Rhinelander, Wisconsin, USA (saw dust was transported for 300 km). An attributional LCA was modelled in SimaPro 8.0.2 and the results were analysed using “IMPACT 2002+” and “ReCiPe” methodologies.

#### 4. Life Cycle Inventory

LCI data (Table 1) were gathered from various sources: smoking media production and application from industries (August Strothlücke GmbH & Co. KG; Gustav Ehlert GmbH & Co. KG; Red Arrow USA); wood growing and sawing from literature sources; environmental impacts were modelled with Ecoinvent 3 databases.

#### 5. Impact assessment results

Midpoint impact characterization indicated the highest impacts in all scenarios associated with categories of non-renewable energy use, global warming and respiratory inorganics impacts (Table 2). Complete life cycle assessment of smoking technologies indicated that scenario (1) had the worst results, scenario (2) had intermediate impacts and scenario (3) had the lowest impacts (Figure 1).

Table 2: impact results (per 1 tonne of raw sausages) of smoking media life cycle (main midpoint impact categories by IMPACT 2002+ and ReCiPe impact methodologies)

Impact category	Unit	Friction Scenario (1)	Smoldering Scenario (2)	CleanSmoke Scenario (3)
Climate change	kg CO <sub>2</sub> eq.	247.83 – 284.21	165.9 – 175.71	126.15 – 141.05
Land use	m <sup>2</sup>	1.1 – 2.47	1.6 – 5.63	0.7 – 1.52
Non-renewable energy	MJ	4522 – 5418	3207 – 3835	2110 – 2523

Figure 1: smoking technologies (per 1 tonne of raw sausages) (complete life cycle of smoking media production and application: from cradle to grave)

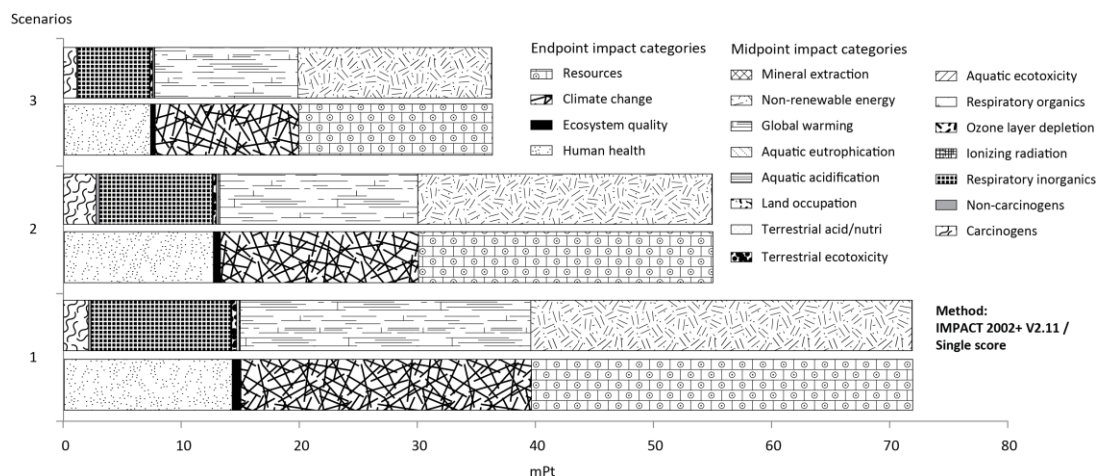

## 6. Conclusion

The worst environmental impact case scenario was highlighted for friction smoking (1), which is connected with the increased need for energy consumption for smoke generation. At the same time scenario (1) was the least environmentally impacting at the stage of smoking media production. However, the impact of smoking media production is negligible in all scenarios as it was responsible for only 1-2%. CleanSmoke application was the best cold food smoking technology applied to raw sausages among compared options. The key driver of environmental impact is the energy use for smoke generation and smoke chamber operations. Lowering the consumption of non-renewable energy could significantly decrease the environmental impacts of food smoking (change from natural gas burning to energy from the grid can decrease the impact by 25%).

## 7. References

- [1] Andreae, M.O. 'Biomass burning: its history, use, and distribution and its impact on environmental quality and global climate', in 'Global Biomass Burning: Atmospheric, Climatic and Biospheric Implications', 1991. 3–21.
- [2] Bari, M.A., Baumbach, G., Kuch, B., and Scheffknecht, G. 'Wood smoke as a source of particle-phase organic compounds in residential areas', *Atmospheric Environment*, 43(31) (2009) 4722–4732.
- [3] Larson, T.V. and Koenig, J. Q. 'Wood smoke: emissions and noncancer respiratory effects', *Annual Review of Public Health*, 15(1) (1994) 133–156.
- [4] Reisen, F., Meyer, C.P. (Mick), McCaw, L., et al. 'Impact of smoke from biomass burning on air quality in rural communities in southern Australia', *Atmospheric Environment*, 45(24) (2011) 3944–3953.
- [5] Red Arrow. 'Environmental Benefits of Using Condensed Natural Smokes', 2014.
- [6] Vorwold, G., and Töpfl, S. 'CO2 emission report for smoking methods using smoke condensates versus traditional methods' Quakenbrück, Germany (2009).
- [7] Doublet, G., Ingólfssdóttir, G. M., Yngvadóttir, E., et al. 'Key Environmental Performance Indicators for a simplified LCA in food supply chains', in 'Proceedings of the 9th International Conference on Life Cycle Assessment in the Agri-Food Sector (LCA Food 2014)', 8–10.
- [8] Meier, T., and Christen, O. 'Environmental impacts of dietary recommendations and dietary styles: Germany as an example', *Environmental Science & Technology*, 47(2) (2013) 877–88.
- [9] Scholz, K. 'Carbon footprint of retail food wastage – a case study of six Swedish retail stores', SLU, Dept. of Energy and Technology, 2013.

# Low Emission Farming – a significant step forward to improve the environmental impacts of livestock production

Michael Binder<sup>1</sup>, Elmar Rother<sup>2</sup> and Thomas Kaufmann<sup>1</sup>

<sup>1</sup>Evonik Nutrition & Care GmbH, Rodenbacher Chaussee 4, 63457 Hanau/Germany

<sup>2</sup>Evonik Infrastructure & Technology GmbH, Rodenbacher Chaussee 4, 63457 Hanau/Germany

E-mail contact: [michael.binder@evonik.com](mailto:michael.binder@evonik.com)

## 1. Abstract

*Animal raising and livestock production are major players in global environmental issues. Different players along the value chain must cooperate to lever existing knowledge and move towards more sustainability-based on science and LCA as the tool to measure overall progress. The supplementation of feed with amino acids reduces feed consumption and the nitrogen content in feed, waste treatment in a biogas plant brings methane emissions to energy production, purification of methane offers new alternatives for improved energy provision and finally, specific treatment of digested residues provides new fertilizer applications. The combination of the different aspects of nutrient management, waste management, emissions management and finally fertilizer treatment enables new ecological and economical improvement potentials evaluated through LCA methodologies.*

## 2. Introduction

Livestock is the major player in global environmental issues. The huge demand for feed crop production shapes entire landscapes and can reduce natural habitats, causing degradation in some areas, technological improvement, but it is also a key driver of global livestock production. Growing productivity has been achieved through advanced breeding and feeding technology, and through irrigation and fertilizer technology in crop production, leading to higher yields per hectare. Intensification, the vertical integration and up-scaling of production also lead to larger units and larger livestock operations. There are also geographic shifts, with production moving away from local natural resources. Animal production is very often separated from crop production and is seen responsible for up to 18% of human induced Greenhouse Gas Emissions GHG [1],[2],[3].

To further reduce livestock production related emissions, it is important to set up advanced technologies such like feed strategies, manure management practices and energy use efficiency [2].

Modern livestock production is characterized by efficient nutrient management to reduce feed consumption, waste management to reduce waste volumes and finally emission management to reduce environmental impacts. All three are followed by efficient energy use and recycling.

## 3. Life Cycle Assessments (LCA)

Life Cycle Assessments (LCA) can be used to display and monitor the specific mitigation option of these measures, but can also help to identify hotspots and further options for improvement. In Science LCA is accepted as methodology to assess the environmental impact of products and processes. Following the definition ISO 14040:2006, LCA represents the “compilation and evaluation of the inputs, outputs and the

potential environmental impacts of a product system throughout its life cycle” [4]. A couple of studies are already in place to show the different scenarios to manage feed, waste or energy, but never before concepts have been developed to bring all the different options together to one holistic solution of a low emission livestock production. In general, life cycle assessments describe the complete fate of a product by compiling and evaluating all ecological input and the consequences for the environment during each phase in the life cycle of the product based on international standards [4],[5],[6]. The present document intends to assess and display the improvement potential of the integrated livestock production on farm level following the concept of the Low Emission Farming applying the LCA methodology.

#### 4. The Low Emission Farming Concept (LEF)

The concept of the “Low Emission Farming” (LEF) as a solution from the chemical industry for the feed to food value chain offers the best practice to reduce livestock related emissions to the lowest possible level on the farm as illustrated in Figure 1.

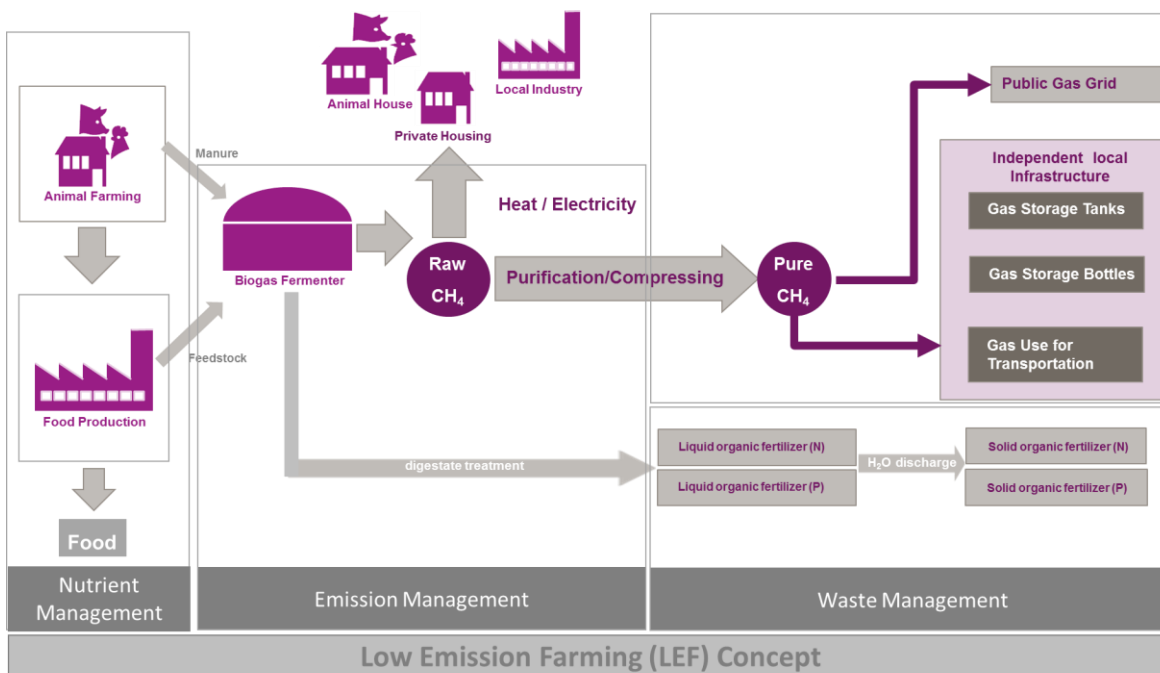

Figure 1: The 3 elements of the Low Emission Farming Concept

The supplementation of feed with amino acids reduces feed consumption and the nitrogen content in feed [7], waste treatment in a biogas plant brings methane emissions to energy production, and the purification of methane offers new alternatives for improved and independent renewable energy provision. Further specific treatment of biogas fermentation residues provides new fertilizer applications. LEF combines the different options for nutrient management, waste management, emissions management and finally fertilizer treatment to show the ecological and economical improvement potentials individually and in combination. These different options are actually in the evaluation process through LCA methodologies to monitor the environmental impacts per stage and to identify further mitigation potentials.

The assessment focusses on the most relevant impact categories in agriculture such like the Global Warming Potential (GWP) excluding biogenic carbon, the Eutrophication Potential (EP) and the Acidification Potential (AP). Due to the ongoing assessment the further presented figures show exemplarily the preliminary results for the GWP. As shown in figure 1, organic waste such like waste from food production can also be used as another option for the feedstock of the biogas plant. Actually, this alternative is not included in the current assessment. Also the direct use of the raw biogas to produce heat and energy is only considered in the assessment of the emission management.

#### *4.1 Nutrient management*

A first step towards a more sustainable livestock production is the increase of productivity through modern feeding technologies. Improving feed efficiency and reducing the nutrient excretion enables mitigation of the overall impact of livestock production. As one example, a life cycle assessment (LCA) for a typical pig and broiler production scenario can demonstrate the very positive environmental benefit of supplementing the first limiting amino acids such like methionine, lysine, Threonine, Tryptophan or Valine to pig and broiler feed [8], [9]. By supplementing deficient diets with these amino acids, soybean meal and corn were replaced and thus, the environmental impacts were significantly improved.

But such an LCA reflects only one exemplary feeding scenario. To demonstrate the sustainability improvement potential of each feed formulation, a new web-based ready to use software AMINOFootprint<sup>®</sup> has been developed and launched to assess the specific environmental impact of each individual pig or poultry diet of any applicant. The tool focuses on calculating ecological profiles of compound feed and enables the identification of diets and logistic scenarios with the least environmental impact. This is a change within the feed industry. Optimizing the nutritional and economic dimensions of compound feed has always been core to the added value that feed additive companies promise to deliver. Now diet evaluation can be also based on the third dimension “ecological balance” as a broad approach to sustainable diets.

#### *4.2 Emission Management*

Another technology following the efficient nutrient management is the emission or waste management, realized in the approach of the “Low Emission Farming” (LEF) concept as shown in figure 1. This concept, as a solution from the chemical industry for the food production, offers the best practice to reduce livestock related emissions to the lowest possible level. The supplementation of feed with amino acids as already mentioned reduces feed consumption and thus, the nitrogen content in feed. This is a first measure to reduce livestock production emissions. With this first measure the reduced amount of manure has also less volumes of nitrogen based emissions, which will in consequence result in less impacts on water, soil or air [7],[8],[9]. As another effect the managing of manure in a biogas plant brings methane emissions to energy production, and thus, additional improvement of emissions normally related to manure storage and disposal. Additional purification of methane offers new alternatives for improved energy provision (own on farm use or external applications). General investigations on the reduction of environmental impacts of livestock production demonstrate the close relationship between feed composition, feed digestion and manure composition at farm

level. These investigations further recommend to use anaerobic digesters to eliminate emissions during manure storage and further applications on the field [3].

#### 4.3 Waste Management

Finally, specific further physical and chemical treatment of biogas fermentation residues provides new fertilizer opportunities allowing more nutrient specific applications in crop production. Due to nutrient management and emissions management, the volume of manure or waste can be reduced, the specific treatment of remaining volumes further support the reduction of the environmental impact and to comply with the more and more strict limitations for nitrogen and phosphorus fertilization of grass- and cropland.

As already highlighted by other investigations [3] in individual assessments for the different elements, this concept combines the different options for nutrient management, waste management, emission management and finally fertilizer treatment for the first time to show the ecological and economical improvement potentials individually and in combination. The LEF concept will completely change in the future from energy production as a core target to effectively manage organic waste and related emissions with energy production as a side effect (figure 2). The economic and ecological feasibility of this concept is currently being evaluated in an Evonik project analyzing the return of investment and calculating the LCA for different scenarios combining the individual modules.

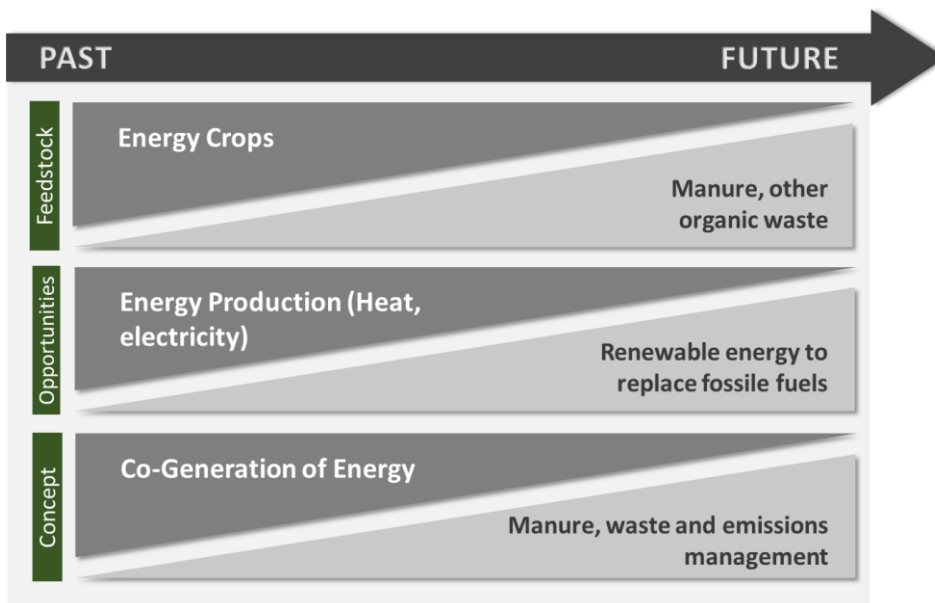

Figure 2: Future trends in livestock production away from single energy production towards advanced emissions and waste management

## 5. Results

To show the general mitigation potential of environmental impacts to air, water and soil, figure 3 displays the contribution to the GWP (excluding biogenic carbon) of the European pig production as a first example. As already mentioned, the assessment is still in progress and the other results for AP and EP will follow, also broken down to other important regions around the globe.

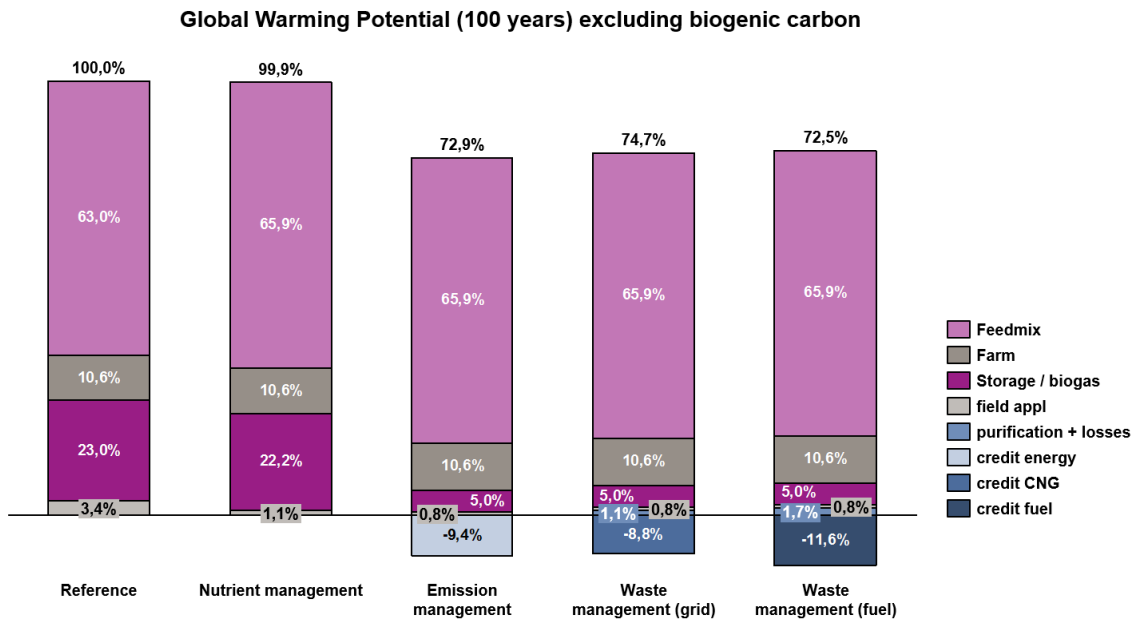

Figure 3: Preliminary results for the GWP mitigation potential of the LEF concept for the European pig production (calculated for 1,000 kg live weight of pigs )

The current assessment starts with the reference scenario where no further measures have been taken to improve feed efficiency or to reduce environmental impacts beyond the regulations or other recommendations. The feed formulation was done without any supplemented feed amino acids, which is in some cases not today's standard all over the world, but in some developing regions it is still practice.

Manure management grounds on good agricultural practice. The further columns in figure 3 show the stepwise implementation of the LEF concept with the impacts on the environmental performance. Thus, the overall contribution to GWP can be reduced from 100% down to 72.5% (figure 3). Increasing feed efficiency and digestibility through advanced nutrient management reduces significantly the emissions from manure storage and manure field application, but shows no overall reduction potential due to higher GWP burdens for the production of amino acids used in the feed compositions. If emissions from land use change are taken into account, there will be a significantly positive effect on GWP by supplementation of pig feed with amino acids. About 25-27 % reduction is the result of implementing emission management and biogas production (figure 3).

Comparable results are expected for the other impact categories AP and EP, for which the assessment is still in progress. Furthermore, the treatment of biogas residues to new fertilizer opportunities is also still under examination.

**Global Warming Potential (100 years) excluding biogenic carbon including emissions from land use change**

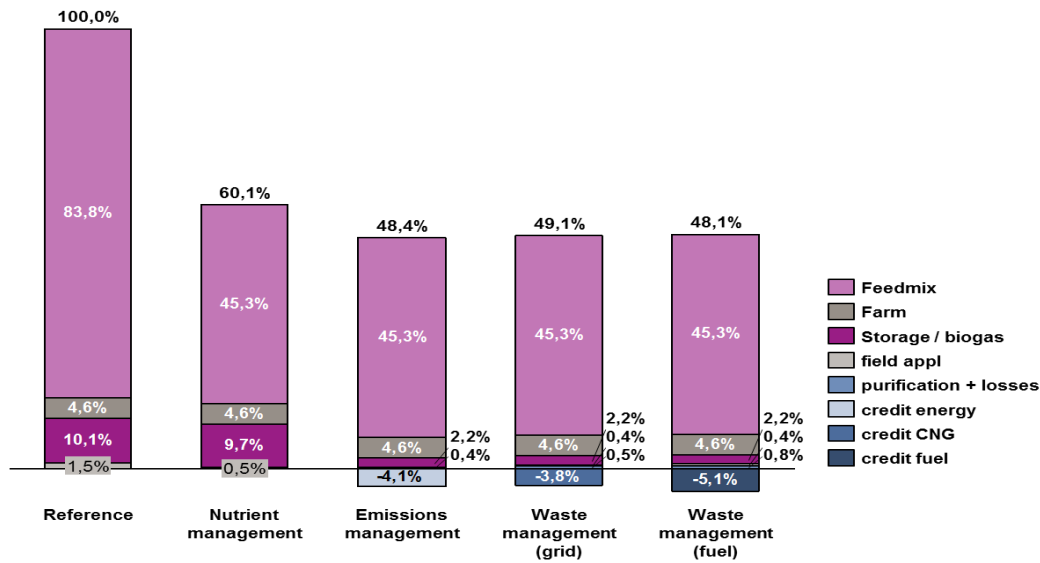

Figure 4: Preliminary results for the GWP mitigation potential of the LEF concept for the European pig production (calculated for 1,000 kg live weight of pigs) including emissions from land use change

If land use change is considered (figure 4), the saving potential for the GWP resulting from the feed mix contribution is significant from 100% down to 60.1%, since imported oilseeds such like soybeans are replaced through locally produced cereals. The overall mitigation potential is about 51.9 % down to 48.1 % implementing all mitigation steps of the concept.

## 5. Conclusion

Low protein diets contribute to reduce the impact of livestock production especially on climate change, acidification and eutrophication in livestock production as explained above exemplarily for pigs and broilers. As for current feeding practices, there is still a major potential to mitigate this impact. There is still a considerable gap between the average content of crude protein in standard diets compared to scientifically proven low protein diets [7],[8],[9].

As shown with the first results in figure 1, additionally to an improved nutrient management further measures within the LEF concept on a farm level lead to a significantly improved ecological performance of livestock production. As the different scenarios in figure 3 are based on one typical feed formulation, further improvement potential can be expected by changing the feed compositions towards reduced crude protein contents [7],[8],[9]. This again yields in further improvements of the subsequent measures. The different applications within the LEF concept not only reduce the environmental impact, but also open new business opportunities for renewable energy production, energy self-provision or advanced organic fertilizer use adapted to specific recommendations as best practice with regard to sustainable agriculture (see Figure 1).



## 6. References

- [1] De Vries, M., de Boer, I.J.M., 2010. Comparing environmental impacts for livestock products: A review of life cycle assessments, *Livestock Science* 128, 1–11
- [2] Gerber, P.J., Steinfeld, H., Henderson, B., Mottet, A., Opio, C., Dijkman, J., Falcucci, A. & Tempio, G., 2013. Tackling climate change through livestock – A global assessment of emissions and mitigation opportunities. Food and Agriculture Organization of the United Nations (FAO), Rome.
- [3] Hristov, A.N., Oh, J., Lee, C., Meinen, R., Montes, F., Ott, T., Firkins, J., Rotz, A., Dell, C., Adesogan, A., Yang, W., Tricarico, J., Kebreab, E., Waghorn, G., Dijkstra, J. & Oosting, S. 2013. Mitigation of greenhouse gas emissions in livestock production – A review of technical options for non-CO<sub>2</sub> emissions. Edited by Pierre J. Gerber, Benjamin Henderson and Harinder P.S. Makkar. FAO Animal Production and Health Paper No. 177. FAO, Rome, Italy
- [4] LEAP, 2015. Environmental performance of animal feeds supply chains guidelines for assessment. Livestock Environmental Assessment and Performance Partnership. FAO, Rome, Italy.
- [5] ISO 14040 Environmental management – Life cycle assessment – Principles and Framework, 2006
- [6] ISO 14044 Environmental management – Life cycle assessment – Requirements and guidelines, 2006
- [7] Li, Q.-F, N. Trottier, and W. Powers, 2015. Feeding reduced crude protein diets with crystalline amino acids supplementation reduce air gas emissions from housing, *J. Anim. Sci.* 2015.93:721–730
- [8] Engenhorst T., Groenke C. and M. Binder 2011, Comparative life cycle assessment of DL-Methionine, L-Lysine, L-Threonine, and L-Tryptophanin broiler and pig production, Evonik 2011
- [9] Haasken C., Binder M, 2015, Comparative life cycle assessment of MetAMINO®, Biolys®, ThreAMINO®, TrypAMINO® and ValAMINO® in broiler and pig production, Evonik 2015, in progress

# Energy and water savings by exploiting nano-technological self cleaning textiles

Elena Busi\*, Simone Maranghi\*, Leopoldo Corsi<sup>#</sup>, Riccardo Basosi\*

\*Department of Biotechnology, Chemistry and Pharmacy, University of Siena, Italy

<sup>#</sup>Next Technology Tecnotessile, Società di Ricerca r.l., Prato (Italy)

E-mail contact: [elena.busi@unisi.it](mailto:elena.busi@unisi.it)

## 1. Abstract

*The exploitation of recent technologies in the production of new generation textiles should be applied in order to achieve energy and raw material savings. Nanotechnology has high technological potential for the textile industry. The new textile realized by a finishing process, is able to reduce the maintenance costs of textile products, including a reduction in the consumption of water and chemicals/detergents, and to significantly reduce the temperature required for the removal of persistent stains. In this study Life Cycle Assessment (LCA) was applied to a self-cleaning textile in order to quantify its environmental advantages. In particular, the ecological earnings were evaluated by the comparison of the production and the use phase of the innovative and conventional materials in several application scenarios.*

## 2. Introduction

In the life cycle of garments, water is not the only primary depleted resource: in fact, approximately one-third of the energy consumed globally is used by the industrial sector [1]. Within this scenario, it was estimated that energy used in the textile industry varies from 3 to 3.5 kWh of electricity per kilogram of yarn. Since wet processes represent the higher consuming step in the textile industry, it is clear that laundry services represent a critical step for energy demand. Nanotechnology can provide high durability for fabrics, because nano-particles have a large surface area-to-volume ratio and high surface energy, thus presenting a better affinity for textiles and leading to an increase in durability of the function [2]. The finishing process consists in the deposition of a layer of nanocrystalline titanium oxide, which is able to destroy organic material by solar irradiation.

## 3. LCA Assumptions and Life Cycle Inventory Analysis

The strategy for the LCA analysis must consider how many times a certain amount of textile has to be washed during its life cycle. As far as the system boundaries are concerned, the original intention was to perform a cradle-to-gate analysis, including the production of the raw materials in the boundaries. In this way, the gathering of data would include the production and the manufacturing of textile. Simply the supplying of feedstock implies the collection of an environmental burden due to ecological choices of the producer both in the case of natural [3] and synthetic fibers [4]. For these reasons, in this work, it was decided not to consider the production phase of the textile, opting for a gate-to-gate LCA. This choice is also supported by the goal and scope of this work. In fact, the comparison between the considered finishing processes is independent from the choice of textile type.

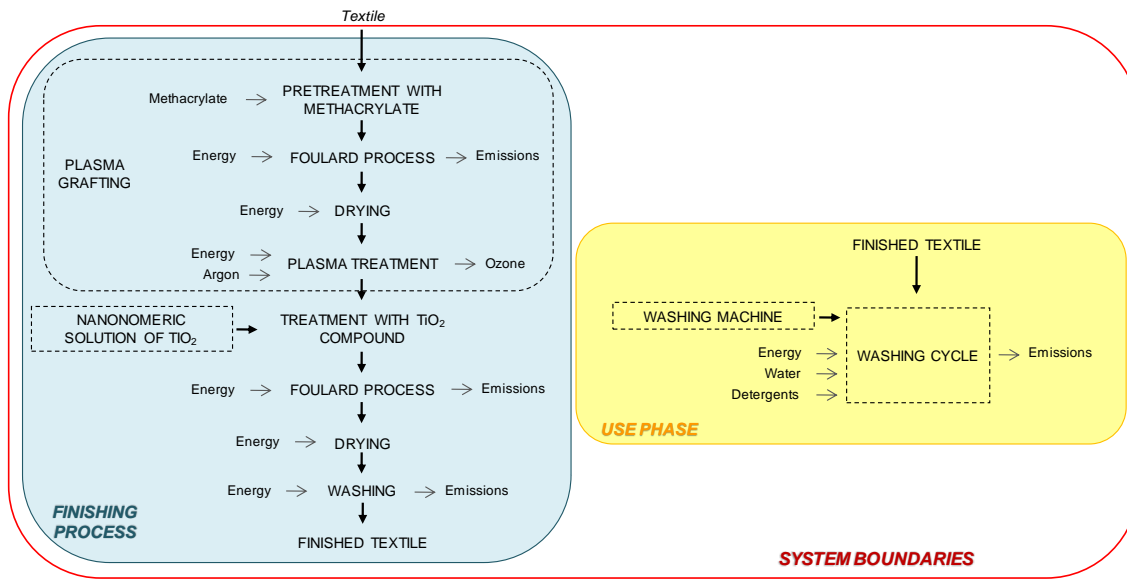

Figure 1: Flow diagram representing the life cycle of innovative textile.

Life cycle system boundaries of innovative textile are reported in Fig 1. In order to simulate a reliable materials and energy requirement during the laundry operations, the consumption data of a commercial washing machine were used [5-7]. Furthermore, the energy and raw materials that are required for the construction of a washing machine are part of the analyzed system.

#### 4. Sensitivity scenarios

To check the influence of methodological choices on the final results, sensitivity analyses were carried out. The assumption of a longer lifespan of the use phase of the garments was tested by varying their durability from 1 to 5 years, to spread the higher impacts of the innovative finishing process. In order to simulate the advantage of photocatalytic degradation of stains that innovative textile should achieve, many different scenarios of reducing electrical consumption, number of washing cycles and reduced amount of detergent were assessed. In Table 1 the values of the number of cycles per year used in the scenarios are reported. Two other parameters were also changed in the sensitivity scenarios: the washing temperature and the use/amount of detergents.

	Innovative washing			Conventional washing
Number of cycles per year	220	130	87	220
$m^3$ of tap water per year	1,37	0,91	0,54	1,37
Washing temperature ( $^{\circ}C$ )	60	40	RT	60
Amount of detergents (kg)	None	0,06		0,12

Table 1: Parameters of the washing scenarios (RT = room temperature).

## 5. Results and Discussion

Considering only the finishing process, it is quite obvious that the innovative finishing process is not environmentally advantageous at this stage if compared with conventional textile. Furthermore, the aim of the LCA analysis is to estimate the reduction of the consumptions during the washing operations, which will compensate the additional environmental impact due to the material and energy inputs of the finishing phase. The combination of the parameters shown in Table 1 provides several scenarios, whose results calculated by CED method [8].

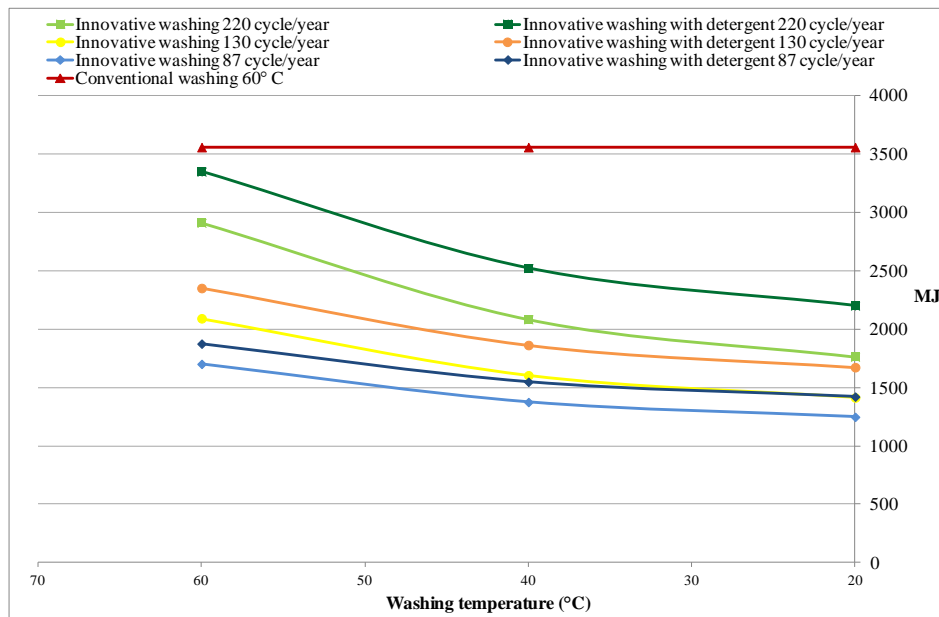

Figure 3: Diagram of CED indicator vs washing temperatures for all the considered scenarios

It is apparent that the innovative washing procedure is energetically much more efficient both reducing the number of cycles per year and the washing temperature. In fact, the first value of the innovative finishing (green line) has the same parameters as the traditional washing process (red line) with the exception of the detergents. Eliminating or merely reducing soaps and auxiliaries, a remarkable energy savings is obtained. Moreover a reduction of the water consumption (about 60%) in the best scenario is achieved as well.

The most relevant impact assessment categories of ReCiPe show the same trend. From an environmental point of view, the innovative textile is more sustainable than the conventional. The large impact is due to the use of detergents during the washing operation being the key process that influences all the scenarios. The environmental burden of detergents affect the final results decisively, even if present in a reduced amount.

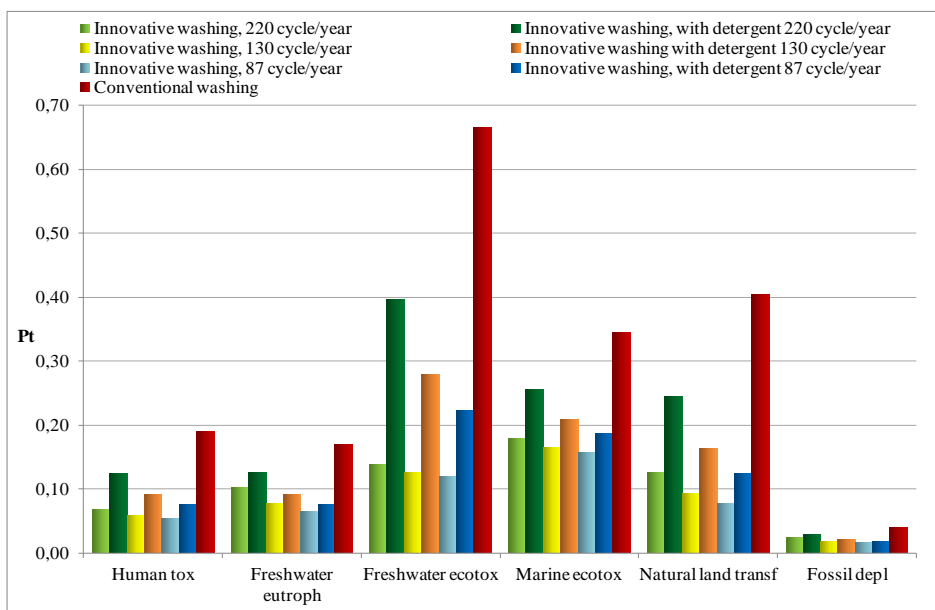

Figure 4: Comparison of the washing scenarios at 40 °C calculated with ReCiPe Midpoint method for the selected impact categories

## 6. Conclusion

During the washing process, the innovative finished textile shows remarkable advantages by simply reducing the use of traditional detergents. The environmental profile is strongly influenced by the presence of detergents. For this reason, the reported results point out a key point in these LCA assessments: the innovative photo-catalytic textile is more eco-sustainable than the conventional one by reducing the chemical compound used for laundry operations. The assessment of the innovative finishing process suggests an industrial development of this technology.

## 7. References

- [1] International Energy Agency (IEA), World Energy Outlook. (Paris, France 2011).
- [2] Walser, T., Demou, E., Lang, D.J., and Hellweg, S., 'Prospective Environmental Life Cycle Assessment of Nanosilver T-Shirts', Environ. Sci. Technol., 45 (2011) 4570–4578.
- [3] Cotton Incorporated, 'The Life Cycle Inventory & Life Cycle Assessment of Cotton Fiber & Fabric', 2010.
- [4] Nieminen, E., Linke, M., Tobler, M. and Beke, B. V. 'EU COST Action 628: life cycle assessment (LCA) of textile products, eco-efficiency and definition of best available technology (BAT) of textile processing'. J. Clean. Prod., 15 (13-14) (2007), 1259-1270.
- [5] Rüdener, I., Gensch, C.O. and Quack, D. 'Eco-Efficiency Analysis of Washing machines - Life Cycle Assessment and determination of optimal life span', Öko-Institute e.V, 2011.
- [6] Bole, R. 'Life-Cycle Optimization of Residential Clothes Washer Replacement'. Report No. CSS06-03 (2006). Center for Sustainable Systems - University of Michigan.
- [7] Cullen, J. M. and Allwood, J. M. 'The Role of Washing Machines in Life Cycle Assessment Studies'. J. Ind. Ecol., 13 (1) (2009), 27-37.

## Selecting an appropriate fuel mix in LCA of energy savings

*Pierpaolo Girardi<sup>1</sup>, Paola Cristina Brambilla<sup>1</sup>, Alessia Gargiulo<sup>1</sup>*

<sup>1</sup>RSE, Via Rubattino 54, 20134 Milano, Italy

E-mail contact: [girardi@rse-web.it](mailto:girardi@rse-web.it)

### 1. Abstract

*Energy efficiency plays a key role in European sustainable development and climate change Policy. In order to analyse the environmental effectiveness of energy efficiency measures and policy, an appropriate tool is the LCA methodology, taking into account the direct and indirect effects of energy saving, along the entire energy supply chain. In this context, particular attention should be paid to the identification of the energy carriers to be considered in energy savings LCA studies. In this paper we demonstrate that the choice of an appropriate fuel mix has a relevant influence on final LCIA results, that vary between 11% (e.g. for greenhouse gases emissions), and more than 100% (e.g. for air acidification), when applied both to average saved energy (heat or electricity) and to a specific energy saving measure (in our case, lighting in the residential sector).*

### 2. Introduction

Energy efficiency plays a key role in European sustainable development and Climate Change Policy [1]. In order to analyse the environmental effectiveness of energy efficiency measures and policy, an appropriate tool is the LCA methodology [2], taking into account the direct and indirect effects of energy saving, along the entire energy supply chain. Despite several studies have been made on the topic ([3][4][5][6]), especially on buildings, underlining the relevance of the energy consumption [7], none of them analysed the role of different mix and how it can affect results. If dealing with heat or electric energy saving, from an environmental point of view, it is important to define how heat or electricity are produced, i.e. which energy sources and which conversion technologies are used, as demonstrated in studies dealing with LCA of electric vehicle [8][9]. For example when evaluating the LCIA of using high efficient lamp instead of traditional incandescent light bulb, whether the electric energy saved is produced by hydro or coal power plant does affect the results. For this reason we propose a method for selecting an appropriate fuel mix in LCA of energy savings according to available data at national level. Then we investigate the impact on LCIA results, comparing the use of selected mix with the use of other possible average national energy mixes, both for the evaluation of national energy efficiency action plan (NEAP) measures and for the evaluation of a specific energy saving technology: LED lamp in residential sector.

### 3. Selecting an appropriate fuel mix for heat and electric energy savings

The most common approach to LCA of electricity energy saving is using the national average energy mix taken from available databases (like Ecoinvent [10][11] or ELCD [12]). Of course each database refers to a specific year: Ecoinvent for the Italian electric mix refers to 2004 (v2.2) or 2008 (v.3.1) while ELCD refers to year 2002. This could be a problem since the contribution of the different energy sources to the overall yearly Italian electricity production varies considerably from year to year [13].

Moreover specific comparisons between TERNA (the national transmission system operator) official statistical data and ELCD mix (referred to year 2002) or Ecoinvent (both for v 2.2 and 3.1) showed that ELCD underestimates electricity production from biomass and other fuels in favor of electricity production from oil derived fuels while Ecoinvent doesn't consider electricity production from biomass and from other gaseous and liquid fuels in both versions [14]. When performing an LCIA these differences could significantly affect the results. For all this reasons we suggest to use ad hoc energy mix considering only fossil energy sources. There are many reasons for this assumption: energy efficiency and renewable are promoted in the same European union strategy; renewables have priority access to the market; renewables have often lower operation and maintenance costs then fossil fuels technologies. Moreover, instead of average national mix, we suggest a marginal fossil fuel mix built on the basis of the index of marginality [9] (available on line at [www.gme.it](http://www.gme.it) for Italy). As regards thermal energy saving in end using sectors, we still consider only fossil fuels but given that there is not a specific stock market (and so any marginal mix) we suggest to build the saved energy mix considering, for each end-use energy sector (residential, industry...[14]) the corresponding actual fossil fuel mix consumption and, for evaluation at national scale, aggregate then data as weighted sum, using the amount of energy saved in each sector as weights.

#### 4. The effect of selecting an appropriate fuel mix in LCIA of energy savings

The effect of selecting an appropriate fuel mix on LCIA results has been tested using as reference the year 2009. We compared the LCIA of one unit of energy saved, both for electric energy and thermal energy of the selected fuel mix with other possible fuel mixes.

For electric energy savings, we compared the marginal fossil mix (Mix 5) with different fuel mixes as described in Table 1.

<i>name</i>	<i>Mix 1</i>	<i>Mix 2</i>	<i>Mix 3</i>	<i>Mix4</i>	<i>Mix5</i>
energy mix	Italian production 2004	Italian production 2008	Italian production 2009	thermal fossil production 2009	fossil marginal production 2009
%	Solid Fuels 15.7%; Natural Gas 47.5%; Derived Gas 2.0%; Oil based fuel 16.7%; Hydro 16.8%; Wind 0.7%; Bioenergy 0.6%.	Solid Fuels 13.6%; Natural Gas 54.4%; Derived Gas 1.7%; Oil based fuel 9.9%; Other solid and gaseous fuel 0.5%; Hydro 14.3%; Wind 1.7%; PV 0.1%; Geothermal 1.8%; Bioenergy 1.9%.	Solid Fuels 13.5%; Natural Gas 49.9%; Derived Gas 1.3%; Oil based fuel 5.4%; Other solid and gaseous fuel 6.6%; Hydro 16.6%; Wind 2.2%; PV 0.2%; Geothermal 1.8%; Bioenergy 2.6%.	Solid Fuels 17.6%; Natural Gas 65.2%; Derived Gas 1.6%; Oil based fuel 7.0%; Other solid and gaseous fuel 8.6%.	Natural Gas Combined-Cycles 73.0%; Coal power plants 12.0%; Oil power plants 11.0%; Natural Gas power plants 2.0%; Gas Turbine Power plants <1%.
data source	Ecoinvent 2.2	Ecoinvent 3.1	Brambilla et al, 2014	Girardi P, 2012	Brambilla et al, 2014

Table 1: Different fuel mixes used for comparison of LCIA of saved electric energy

Results (Figure 1) show that the proposed mix (Mix 5) has lower impacts (and energy saving results in lower avoided impacts) and differences vary from about of 11% for Climate change impact category to 100% in the case of Air Acidification. The choice of an appropriate energy mix affects not only the LCIA of the average energy saved but also the LCIA of a single measure. Figure 2 shows for example the effect of using Mix 1 or Mix 5 when comparing high efficient lamps (LED) with traditional lamps, for Climate Change and Air Acidification impact categories. Even if the technologies ranking doesn't change, the differences on impacts in absolute terms are relevant.

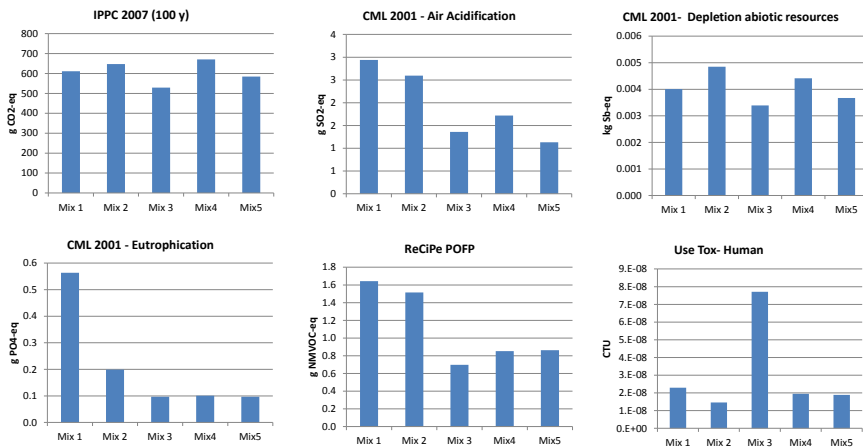

Figure 1: LCIA for different energy mixes for 1 kWh of saved thermal energy

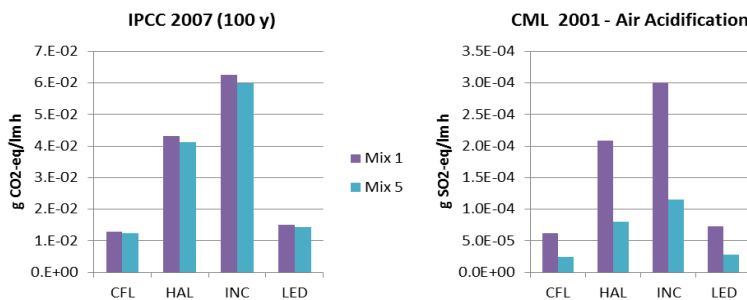

Figure 2: LCIA for 1 lmn\*hour of LED lamp vs CFL, halogen (HAL) and incandescent bulb (INC).

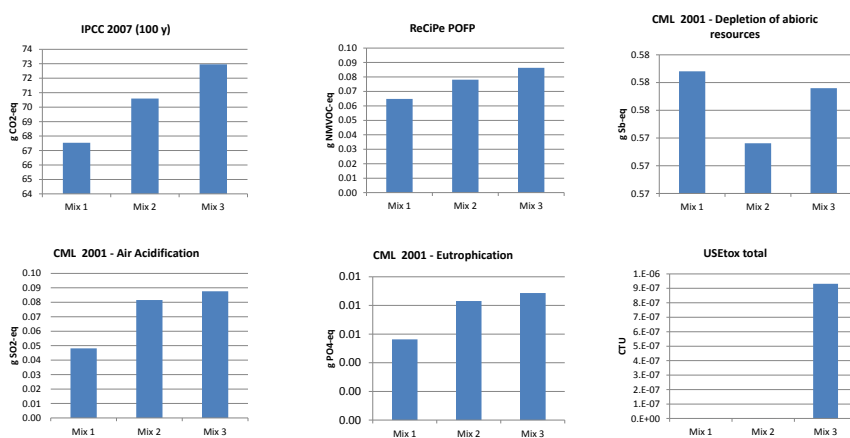

Figure 3: LCIA for different mixes for 1 MJ of saved thermal energy



In the case of thermal energy (Figure 3) the differences are of the same order of magnitude but in this case the selected mix (Mix 3, actual fossil fuel mix consumption) has higher impacts (and then energy saving results in higher avoided impacts) than Mix 1 (only natural gas burned in an industrial furnace) and Mix 2 (the fossil fuel mix of industry sector)[14].

## 5. Conclusions

In this paper we propose a method for selecting an appropriate fuel mix in LCA of energy saving both for energy policy (like national efficiency action plans) and for single technologies (like high efficient lamps for residential lighting). Results shows that use of the proposed fuel mixes, based on fossil fuels and marginal technologies, has a relevant effect on improving LCIA results as far as the influence varies between 11% (e.g. for Greenhouse gases emissions), and more than 100%, (e.g. for Air Acidification) both when applied to average saved energy (heat or electricity) and to a specific energy saving measure (in our case, lighting in the residential sector).

## 6. Acknowledgements

This work has been financed by the Research Fund for the Italian Electrical System decree of Italian Economic Development Ministry November 9th 2012 and following.

## 7. References

- [1] European Commission, 2015, A Framework Strategy for a Resilient Energy Union with a Forward-Looking Climate Change Policy, communication from the Commission to the European Parliament, the Council, the European Economic and Social Committee, the Committee of the Regions and the European Investment Bank, Energy Union Package, Brussels
- [2] Blengini G. A., Di Carlo T., 2010. The changing role of life cycle phases, subsystems and materials in the LCA of low energy buildings. *Energy Buildings* 42,869-880.
- [3] Blengini, G.A., 2009. Life cycle of buildings, demolition and recycling potential: a case study in Turin–Italy. *Build Environ* 44,319–330.
- [4] Adalberth, K., Almgren, A., Petersen, E.H., 2001. Life cycle assessment of four multi-family buildings. *Int J Low Energy Sustainable Buildings* 2,1–21
- [5] Blanchard, S., Reppe, P., 1998. LCA of a residential home in Michigan. School of Natural Resources and Environment. University of Michigan, USA.
- [6] Scheuer, C., Keoleian, G.A., Reppe, P., 2003. Life cycle energy and environmental performance of a new university building: modelling challenges and design implications. *Energy Build* 35,1049–1064.
- [7] Sartori, I., Hestnes, A.G., 2007. Energy use in the life cycle of conventional and low-energy buildings: a review article. *Energy Build* 39,249–257.
- [8] Hawkins T, Gausen O, Strømman A (2012) Environmental impacts of hybrid and electric vehicles—a review. *Int J Life Cycle Assess* 17(8):997–1014.
- [9] Girardi, Pierpaolo A Gargiulo, Alessia A Brambilla, Paola Cristina (2015) A comparative LCA of an electric vehicle and an internal combustion engine vehicle using the appropriate power mix: the Italian case study, *Int Journal of Life Cycle Assessment*, 10.1007/s11367-015-0903-x.
- [10] Ecoinvent Database v 2.2, 2010. Swiss Centre for Life Cycle Inventories. <http://www.ecoinvent.org>.
- [11] Ecoinvent Database v 3.1, 2014. Swiss Centre for Life Cycle Inventories. <http://www.ecoinvent.org>.
- [12] ELCD (European reference Life Cycle Database) v 3.0. Joint Research Centre, <http://eplca.jrc.ec.europa.eu/ELCD3/>.
- [13] Terna, 2014. Energy transmission grid operator. Statistical data on electricity in Italy. [www.terna.it](http://www.terna.it)
- [14] Brambilla, P.C., Gargiulo A., Girardi P., 2014. Valutazione delle prestazioni ambientali dei vettori energetici mediante metodologia LCA al fine di considerare gli effetti diretti, in termini di ridotte pressioni ambientali, del risparmio di energia negli usi finali. Report RdS RSE 1400178

# Assessing the impacts of onshore wind energy by using a spatio-temporal LCA approach

Authors: Marina Maier, Markus Mueller

Environment and Sustainability Institute

University of Exeter, Penryn Campus, Penryn, TR10 9FE, Cornwall, UK

E-mail contact: [mm566@exeter.ac.uk](mailto:mm566@exeter.ac.uk)

## 1. Abstract

*Using temporally and spatially explicit information to quantify environmental impacts of renewable energy technologies is gaining importance. To address limitation of traditional Life Cycle Assessment (LCA) studies, a dynamical LCA method, that uses spatio-temporal mathematical models to identify environmental impacts varying over time and space, is introduced and exemplified through onshore wind turbines. The methodology incorporates spatial and temporal variability concerning the different life stages of a wind turbine and is applied at the Life Cycle Inventory (LCI) stage. Calculations evolve environmental impacts associated to a renewable energy system in time and space and allow to build impact scenarios depending on, for example, the choice of locations for deployment/installation and the surrounding areas. This novel methodology represents a major step forward in the calculation of comprehensive LCA.*

## 2. Introduction

Wind is a pervasive and infinite power resource that plays a consequential role not only to meet increasing energy demand, but also to achieve CO<sub>2</sub> emission reduction targets. The endeavour for a cleaner environment and more sustainable production processes leads to a rapid and global growth of the on- and offshore wind energy sector. Thus, wind energy is one of the first renewable energy source (RES) that became economically attractive. Wind turbines and wind energy have been the subject of many studies [1]. Life Cycle Assessment (LCA) is applied to assess environmental impacts [2]. LCA is “primarily a steady-state-tool” that does not consider temporal or spatial information [3]. These limitations impact on results of conventional LCA and many, in particular, environmental issues cannot be determined explicitly [4], [5]. In recent years more studies include either temporally or spatially explicit information, and new methodologies for time-dependent LCA [4], [6], [7] and spatial LCA [8], [9] have been developed. To the best knowledge of the authors however, no studies have been performed that include time- as well as space-dependent information, and hence form the aim of the present study: the integration of both, temporal and spatial information and modelling to a more comprehensive results from LCA.

## 3. Method

The spatio-temporal methodology to calculate dynamic LCA, exemplified for potential environmental impacts from onshore wind turbines, is incorporated in the LCI stage. The traditional input/output format for Life Cycle Inventory (LCI) calculation equation,

$$\vec{g} = E \cdot (I - T)^{-1} \cdot \vec{r},$$

is expanded to include time- and space-dependent information. This extends the above vectors and matrices, inventory vector  $\vec{g}$ , environment matrix  $E$ , technology matrix  $T$  and scenario vector  $\vec{r}$ , to four and five dimensional arrays (representing two space- and one time-dimension), respectively.

### 3.1 Time-dependent LCA Model

First, the inputs and outputs of all process flows within a life cycle of a wind turbine are defined in a technology matrix  $T$ . The matrix entries represent the interrelation of all sub-processes within the overall life cycle. All inputs and outputs of the environmental flows are determined in the environment matrix  $E$ , which maps the technological processes to environmental impacts. Each entry of the matrices are considered as temporal distributions of the process related information flows, see *Figure 1a*) for a schematic representation.

Figure 1: a) Example of matrix entries with distributions, b) Convolution of matrices

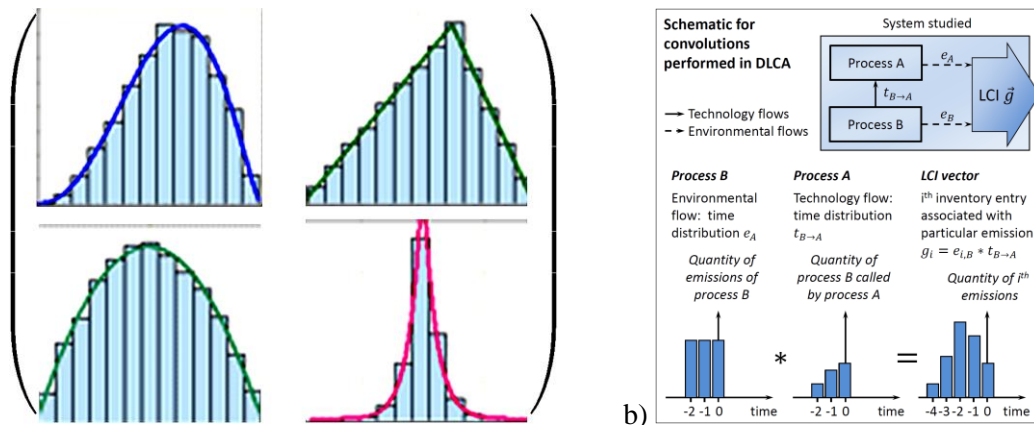

Given a scenario vector  $\vec{r}$  (again, a potentially time-dependent and time-varying variable), the first part of the calculation concentrates on the temporal aspect and does not consider the spatial component. The LCI equation needs to be modified to acknowledge the time-varying information: instead of matrix-matrix and matrix-vector multiplication, individual matrix entries of  $E$ ,  $T$  and  $\vec{r}$  are instead convoluted with each other. That is, new time-distributions are obtained as convolutions of original time-distributions (not as products); see *Figure 1b*) for a schematic of convolution. The temporal calculations do not consider any spatial variation, in that impacts are implicated only locally, for example, at the site of the wind turbine installation.

### 3.2 Spatial Propagation Model

The result from the time-dependent LCI equation serves as input to the spatial propagation models. The time-dependent localised impact inventory vector is propagated based on geographical information (e.g., regional land use and landscape features) or dynamical propagation models (e.g., regional atmospheric and water flows) to obtain time- and space-varying impact inventories. Based on parameter maps for ratios of propagated impact, see *Figure 2a*), and propagation models quantifying the impact of per-time-step dispersed, see *Figure 2b*), the spatially sampled impacts are calculated. First, deployment is assumed at given coordinates (origin), then environmental impacts disperse according to ratios to the closest and diagonally surrounding areas, and are subject to scaling via impact parameter maps. Finally and over time, accumulated long-term impacts decline.

The above model may lead to a better understanding of impacts from construction, maintenance and operation stages of the life cycle. With decommissioning, direct impacts diminish, however may have longer-term and slower decreasing repercussions on the surrounding areas.

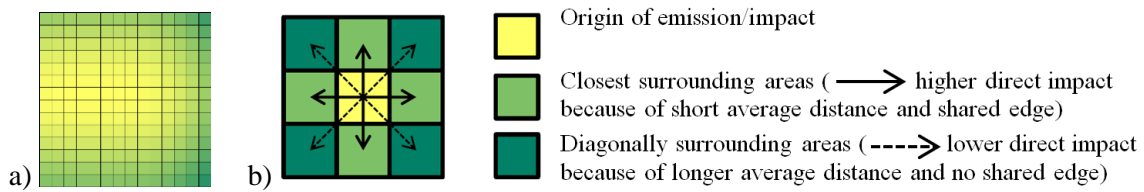

Figure 2: a) Example impact parameter map (bright = high impact, dark = low impact),  
b) Conceptual propagation model for spatial dispersion of impacts.

The spatial propagation model may help to identify impacts on, for example, land and seascape, water cycles, emissions and impact on climate, weather conditions, and surface interactions.

#### 4. Example Simulation

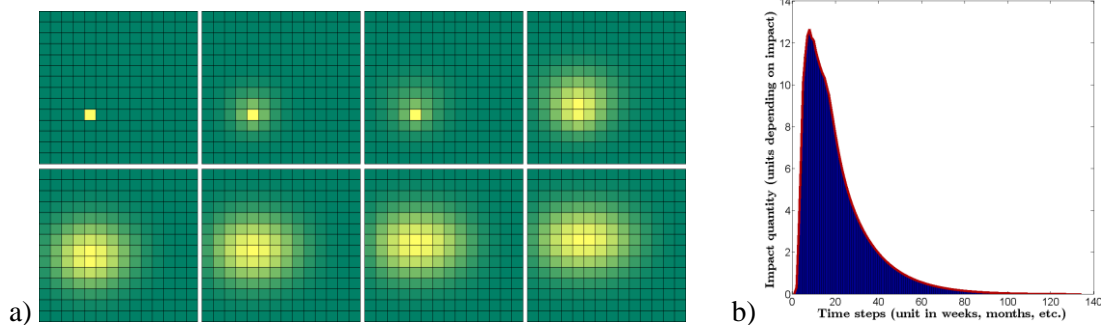

Figure 3: Simulation results; a) Spatio-temporal relative impacts at time steps  $n=1,11,16,21,26,31,41,71$ ,  
b) Summative impacts of simulation region (15x15 grid) over time

The origin coordinates are identified for the wind turbine deployment and time-varying impacts are calculated. Then impacts propagate from the location of deployment to the surrounding areas. At a certain point the impacts start to decrease, first at the deployment coordinates then at surrounding areas, see Figure 3b). Smith et al. [10] (2014) studied the impact of wind turbine deployment on peatlands and concluded that potentially more CO<sub>2</sub> is released from peatlands than is saved because of clean energy from wind during the life of a wind turbine. The proposed model can help to identify these effects in more detail over time and space.

#### 5. Conclusion

The introduced method combines a temporal and spatial LCA approach. Although the method is still in an early development stage, potentially highly beneficial outcomes can already be identified. The method can be used to plan energy scenarios, to minimise the environmental impact of renewable energy technologies during their life cycle, or to identify the impact of wind turbine locations with regard of the soil characteristics. Next steps include multi objective optimisation strategies for multi-impact wind farms and other renewable energy technologies.

Further analysis will also focus on different models for spatio-temporal propagation methods and include more detailed dispersion and dissipation models. It will also be tested if reversing temporal and spatial calculation steps has a significant impact on the results.

## 6. References

- [1] T. Abassi, M. Premalatha and S. A. Abassi, "Wind energy: Increasing deployment, rising environmental concerns," *Renewable and Sustainable Energy Review*, 31 (2014) 270–288.
- [2] E. Martínez, E. Jiménez, J. Blancob and F. Sanzb, "LCA sensitivity analysis of a multi-megawatt wind turbine," *Applied Energy*, 87 ( 7) (2010) 2293–2303.
- [3] H. U. d. Haes, "How to approach land use in LCIA or, how to avoid the Cinderella effect," *The International Journal of Life Cycle Assessment*, 11 (4) (2006) 219-221.
- [4] A. Levasseur, P. Lesage, M. Margni, M. Deschenes and R. Samson, "Considering Time in LCA: Dynamic LCA and its Application to Global Warming Impact Assessments," *Environmental Science & Technology*, 44 (8) (2010) 3169-3174.
- [5] J. Owens, "Life-cycle assessment: Constraints on Moving from Inventory to Impact Assessment," *Journal of Industrial Ecology*, 1 (1) (1997) 37-49.
- [6] H. Dyckhoff and T. Kasah, "Time Horizon and Dominance in Dynamic Life Cycle Assessment," *Journal of Industrial Ecology*, (2014) Online.
- [7] European Commission, "ILCD handbook: International reference life cycle data system. General guide for life cycle assessment: Detailed guidance," (Publications Office of the European Union, Luxembourg, 2010).
- [8] R. Geyer, D. M. Stoms, J. P. Lindner, F. W. Davis and B. Wittstock, "Coupling GIS and LCA for biodiversity assessments of land use," *The International Journal of Life Cycle Assessment*, 15 (5) (2010) 454-467.
- [9] C. L. Mutel and S. Hellweg, "Regionalized Life Cycle Assessment: Computational Methodology and Application to Inventory Databases," *Environmental Science Technology*, 43 (15) (2009) 5797–5803.
- [10] J. Smith, D. R. Nayak and P. Smith, "Wind farms on undegraded peatlands are unlikely to reduce future carbon emissions," *Energy Policy*, 66 (2014) 585-591.

# Life Cycle Assessment of Palm Biodiesel Production in Thailand: Impacts from Improvement Technologies, Land Use Changes and Modelling Choices

Trakarn Prapasongsa<sup>1</sup> and Shabbir H. Gheewala<sup>2,3</sup>

<sup>1</sup>Department of Civil and Environmental Engineering, Mahidol University, Nakhon Pathom, Thailand

<sup>2</sup>The Joint Graduate School of Energy and Environment, King Mongkut's University of Technology Thonburi, Bangkok, Thailand

<sup>3</sup>Centre for Energy Technology and Environment, Ministry of Education, Bangkok, Thailand

E-mail contact: [trakarn.pra@mahidol.ac.th](mailto:trakarn.pra@mahidol.ac.th)

## 1. Abstract

*This study assessed environmental consequences of additional palm-oil biodiesel demand in Thailand in comparison with conventional diesel. It was found that improvement technologies enhanced the benefits on climate changes. Inclusion of direct and indirect land use changes and different modelling choices highly affected the environmental benefits and degradation.*

## 2. Introduction

Palm oil has been promoted as a major feedstock for biodiesel production in South–East Asian countries including Thailand during the past decade. A number of environmental benefits (e.g. reduction in global warming and acidification potentials) and drawbacks (e.g. increase in eutrophication potential) from palm biodiesel as well as impacts from alternative technologies in Thailand have been previously addressed [1-3]. Nevertheless, the existing life cycle assessment (LCA) studies considered limited land use change impacts and usually applied attributional LCA (ALCA) modelling approach by using various allocation factors and incorporating average suppliers/technologies. In the meanwhile, recent developments in agricultural production and palm oil industry in Thailand have shown that the fresh fruit bunch yields have increased more than 25% from 2009 to 2013 and most of the Thai palm oil mills have installed a biogas system for wastewater treatment. This study aims to assess life cycle environmental impacts from additional palm-based biodiesel demand in Thailand in comparison with conventional diesel using consequential LCA (CLCA) modelling (avoiding co-product allocation by system expansion and including marginal/actual affected suppliers) and ALCA as well as considering recent development and land use changes.

## 3. Material and methods

CLCA aiming at modelling consequence from a change in demand of palm-biodiesel is applied by including marginal/actual affected suppliers for electricity and fertilizer according to Ref. [4] and avoiding co-product allocation by system expansion. The functional unit of this assessment is 1,000 L of additional palm biodiesel production. The data were mainly obtained from existing studies where field data were gathered from small- and large-scale farms, six palm oil mills and one commercial biodiesel production plant in Thailand [1, 2, 5, 6]. Life cycle stages of palm-oil biodiesel systems are oil palm plantation, palm oil milling, transport and biodiesel conversion. Under consequential modelling, the co-products from the palm-oil biodiesel system including palm kernel, palm shell, palm kernel oil, palm kernel meal and glycerol will substitute marginal electricity production (palm kernel and shell), refined oil (palm kernel oil), feed energy

(palm kernel meal and glycerol) and feed protein (palm kernel meal) in the global market [7]. Direct and indirect land use change impacts are estimated by considering carbon stock changes from direct land transformation [3] and applying a biophysical indirect land use change model [8] with the use of specific data from Ref. [4]. The ReCipe2008 method [9] is selected to assess the life cycle impacts of palm biodiesel under the categories of climate change, photochemical oxidant formation, terrestrial acidification, human toxicity and freshwater and marine eutrophication potentials. In this assessment, seven scenarios are developed as follows. **Scenario 0 (S0)** considers palm-biodiesel under average condition with approximately 70% biogas capture in palm oil mill effluent treatment [2]. **Scenario 1 (S1)** and **scenario 2 (S2)** include palm biodiesel without and with biogas capture during the milling stage, respectively. **Scenario 3 to scenario 6 (S3-S6)** apply improvement technologies (only for palm oil mill effluent treatment with the traditional biogas system consisting of an open pond, a biogas plant, a stabilization pond and a retention pond) while maintaining other conditions as **S2**. The technologies are a wastewater-dispersed unit for cooling instead of an open pond (**S3**), replacement of an open pond before a biogas plant with a covered pond (**S4**), performance enhancement in the existing biogas recovery system (**S5**) and displacement of a stabilisation pond after a biogas plant by an aerated lagoon (**S6**). Finally, **scenario 7 (S7)** applies an attributional LCA by using economic allocation and average electricity data in Thailand.

#### **4. Results and Discussion**

Potential environmental impacts of the palm biodiesel systems and the diesel system shown in **Table 1** indicate that all palm biodiesel scenarios yield lower climate change impacts than the diesel baseline. The improved wastewater treatment systems (**S3-S6**) can strengthen the reduction in climate change impact. With respect to human toxicity, palm biodiesel systems under consequential modelling (**S0-S6**) also have lower impacts whereas the one under attributional impacts (**S7**) have almost double the value of diesel production and use because the economic-allocated impacts of **S7** are still high. Moreover, **S7** does not gain the environmental benefits from the avoided impacts from co-product substitution.

Environmental impacts	Life cycle scope	Diesel	Palm biodiesel							
			S0	S1	S2	S3	S4	S5	S6	S7
Climate Change (kg CO <sub>2</sub> eq.)	Production	254	84 - 425	732 - 1073	(-57) - 284	(-227) - 114	(-225) - 116	(-160) - 181	(-119) - 222	615 - 956
	Production + Use	2760	141 - 482	790 - 1131	1 - 342	(-170) - 171	(-168) - 173	(-102) - 239	(-62) - 279	672 - 1013
Human toxicity (kg 1,4-DB eq.)	Production	83.19	(-7.56)	(-30.00)	(-30.00)	(-29.90)	(-36.68)	(-76.97)	(-19.91)	161.79
	Production + Use	93.54	2.78	(-19.66)	(-19.66)	(-19.56)	(-26.33)	(-66.63)	(-9.56)	172.14
Photochemical oxidant formation (kg NMVOC)	Production	3.67	5.30	5.21	5.21	5.21	5.17	4.97	5.26	6.69
	Production + Use	25.45	27.08	26.99	26.99	26.99	26.95	26.75	27.04	28.47
Terrestrial acidification (kg SO <sub>2</sub> eq.)	Production	3.38	8.08	7.77	7.78	7.78	7.71	7.29	7.88	6.74
	Production + Use	15.37	20.07	19.77	19.77	19.77	19.70	19.28	19.87	18.73
Freshwater eutrophication (kg P eq.)	Production	0.07	(-0.15)	(-0.21)	(-0.21)	(-0.21)	(-0.22)	(-0.28)	(-0.20)	0.42
	Production + Use	0.07	(-0.15)	(-0.21)	(-0.21)	(-0.21)	(-0.22)	(-0.28)	(-0.20)	0.42
Marine eutrophication (kg N eq.)	Production	0.71	7.67	7.66	7.66	7.66	7.65	7.56	7.69	2.51
	Production + Use	8.95	15.91	15.90	15.90	15.90	15.89	15.80	15.93	10.75

Table 1: Potential environmental impacts of palm biodiesel in 7 scenarios considering various technologies and modelling choices in comparison with diesel (per 1000 L of biodiesel equivalent). "Production" and "production + use" are considered from cradle-to-gate and all life cycle stages, respectively.

S0 (CLCA: Baseline scenario)	Total	Oil palm plantation			Palm oil milling			Transport	Biodiesel conversion
Environmental impacts		Plantation	iLUC	dLUC	Milling	Co-products	POME treatment		
Climate Change (kg CO <sub>2</sub> eq.)	84 - 425	587	503	(-430) - (-771)	68	(-846)	348	216	(-22)
Human toxicity (kg 1,4-DB eq.)	(-7.56)	113.50	17.73		8.25	(-185.97)	0.00	11.89	27.04
Photochemical oxidant formation (kg NMVOC)	5.30	3.23	0.28		0.18	(-1.29)	0.00	2.99	(-0.09)
Terrestrial acidification (kg SO <sub>2</sub> eq.)	8.08	4.30	7.15		0.15	(-3.78)	0.00	1.75	(-1.49)
Freshwater eutrophication (kg P eq.)	(-0.15)	0.37	0.01		0.01	(-0.54)	0.00	0.01	(-0.01)
Marine eutrophication (kg N eq.)	7.67	1.18	7.69		0.07	(-1.08)	0.00	1.00	(-1.18)

Table 2: Potential environmental impacts of 1,000 L palm production which are assessed by consequential modelling under the baseline condition (S0).

(iLUC = Indirect land use change; dLUC = Direct land use change; POME = Palm oil mill effluent)



The substitution of palm kernel, palm shell, palm kernel oil, palm kernel meal and glycerol highly contributes to the obtained environmental benefits of **S1** to **S6**. For other impacts, the biodiesel system has lower values. If the impacts from each life cycle stage are considered (see an example of **S0** in **Table 2**), for palm biodiesel systems the important fraction of environmental benefits is obtained from the avoided impacts from the co-product substitution whereas the environmental hotspots are in plantation (excl. iLUC) and iLUC. **S0** to **S6** yield lower human toxicity potential because of the avoided impacts from the co-product substitution. However, the emissions with high human toxicity potential derived from chemical production and consumption may occur during the plantation stage in Thailand (i.e. 113.50 kg 1,4-DB eq. for plantation; see **Table 2**). For iLUC, land intensification by nitrogen fertiliser utilisation is the main cause for acidification and eutrophication. For dLUC, the land transitions from set-aside, cassava, and rubber to oil palm plantation result in avoided climate change impacts.

## 5. Conclusion

Different modelling choices (CLCA and ALCA) and inclusion of direct and indirect land use changes highly influences the environmental benefits and degradation when comparing with the reference biodiesel system. With respect to environmental benefits, there is reduction in climate change and human toxicity due to biogenic combustion and the avoided impacts from the co-product substitution. The improvement technologies enhance the benefits on climate change. Furthermore, the control of chemical usage in oil palm plantation is highly recommended so as to limit the adverse impacts on human health. Finally, although direct land use change results in environmental benefits, there are more drawbacks from indirect land use change in most of impact categories. Future studies should consider other land use change models as well as additional impact reduction alternatives for palm biodiesel production.

## 6. References

- [1] Silalertruksa, T. and Gheewala, S.H., 'Environmental sustainability assessment of palm biodiesel production in Thailand', *Energy*. 43 (2012) 306-314.
- [2] Kaewmai, R., H-Kittikun, A., Suksaroj, C. and Musikavong, C., 'Alternative technologies for the reduction of greenhouse gas emissions from palm oil mills in Thailand', *Environ. Sci. Technol.* 47 (2013) 12417-12425.
- [3] Silalertruksa, T. and Gheewala, S.H., 'Food, fuel, and climate change. Is palm-based biodiesel a sustainable option for Thailand?', *J. Ind. Ecol.* 16 (4) (2012) 514-551.
- [4] Prapasongsa, T. and Gheewala, S.H. 'Risks of Indirect Land Use Impacts and Greenhouse Gas Consequences: An Assessment of Thailand's Bioethanol Policy', *J. Clean. Prod.* (2015) doi: 10.1016/j.jclepro.2015.05.091.
- [5] Suttayakul, P., H-Kittikun, A., Suksaroj, C., Mungkalasiri, J., Wisansuwannakorn, R., and Musikavong, C. 'Water footprints of products of oil palm plantations and palm oil mills in Thailand', Submitted to *Sci. Total. Environ.* (2015).
- [6] OAE (Office of Agricultural Economics) 'Agricultural statistics of Thailand 2014' (OAE, Ministry of Agriculture and Co-operatives, Bangkok, 2015).
- [7] Schmidt, J.H., 'Life cycle assessment of five vegetable oils', *J. Clean. Prod.* 87 (2015) 130-138.
- [8] Schmidt, J.H., Weidema, B.P. and Brandão, M., 'A framework for modelling indirect land use changes in life cycle assessment', *J. Clean. Prod.* 99 (2015) 230-238.
- [9] Goedkoop, M., Heijungs, R., Huijbregts, M., De Schryver, A., Struijs, J. and van Zelm, R. 'ReCiPe 2008', First edition. Report I: Characterisation. (2009).

# Energy recovery from garden waste in a LCA perspective

*Irina Naroznova<sup>1</sup>, Jacob Møller<sup>1</sup>, Charlotte Scheutz<sup>1</sup>*

*<sup>1</sup>Department of Environmental Engineering, Technical University of Denmark (DTU);*

*Miljoevej, Building 113, 2800 Kgs. Lyngby, Denmark*

*E-mail contact: [irin@env.dtu.dk](mailto:irin@env.dtu.dk)*

## 1. Abstract

*According to the common strategies regarding waste management and energy supply in EU countries, more efficient utilization of organic waste resources (including garden waste) with both nutrient and energy recovery is desired. Each of the most common treatments applied today – composting, direct use on land and incineration – only provides one of the two services. A technology ensuring both nutrient and energy utilization is anaerobic digestion (AD) that has become applicable for treatment of garden waste recently. In this study, life cycle assessment aimed to compare four garden waste treatment alternatives (AD, composting, direct use on land and incineration) was conducted. The results showed that none of the scenarios assessed was best in all impact categories simultaneously, i.e. an overall ranking of the technologies was not possible. Moreover, many trade-offs between nutrient and energy recovery were observed.*

## 2. Introduction

According to the common strategies regarding waste management and energy supply in EU countries, more efficient utilization of organic waste resources with both nutrient and energy recovery is desired. For garden waste, the most common treatment applied today is windrow composting or direct use on land. These treatments aim for nutrient recovery only and do not provide energy recovery from the waste. A promising solution to this is the anaerobic digestion (AD) process where both nutrients and energy can be utilized. Another technology suitable for energy recovery is incineration. In that case, however, the nutrients are lost. Full-scale AD does require the waste being pumpable and to some extent homogenized and has, therefore, been considered as less applicable for garden waste treatment. A solution to this was, however, recently demonstrated: a Danish technology designed for food waste pre-treatment prior to biogas production was applied and successful treatment trials on garden waste and food waste mixtures with garden waste content up to 50% were performed.

The objective of this study was to evaluate the environmental performance of garden waste AD and compare it to the treatment alternatives mentioned above, i.e. composting, direct use on land and incineration. To conduct the study, four corresponding scenarios were constructed and the potential environmental impacts including a number of impact categories were assessed using a life cycle assessment (LCA) approach.

## 3. Methodology

### 3.1 Scope

Consequential LCA was applied meaning the changes in impact potentials induced by changes in the system were assessed. The functional unit was 1 tonne of garden waste (wet weigh) being treated, and all the input and output flows were related to it. For the life cycle impact assessment (LCIA), the ILCD2011

recommended method [1] was applied and normalized results expressed in (mili) person equivalent evaluated. The impact potential in the “general” impact categories, e.g. global warming, stratospheric ozone depletion, etc. (see Figure 1), in the toxic categories as well as abiotic resource consumption were investigated. Due to a large uncertainty associated with the LCIA method used the results regarding toxicity were excluded. The modelling was performed using the waste management software EASETECH [2] and included use of both default processes available in the model database and some developed specifically to this study. All the inventories are supposed to cover technology level and practices in Scandinavia and be valid for the present situation in 2015 and some years ahead as long as no major changes of the background systems take place.

### *3.2 Main assumptions*

In the AD scenario and incineration scenarios, system expansion to credit substitution of energy production was used and the marginal technologies modelled. For the electricity, coal-based power production which is generally accepted as the short-term electricity marginal in Scandinavian countries [3; 4] was considered. To assess uncertainty accompanied with the choice, two sensitivity analysis with electricity marginal based on natural gas and wind power were performed. For the heat, a Danish district heating system was used. In modelling, the corresponding inventories available in the software database were used. Following the current Danish legislation [5], use of the digestate from AD, compost and untreated garden waste on land was not considered to substitute inorganic fertilizers.

For the garden waste pre-treatment prior to AD, the technology was associated with an electricity consumption of 41 kWh per 1 tonne waste treated. 8% of the input material (wet weight) was lost in the process reject which in turn was assumed to be incinerated. For other garden waste treatment alternatives, consumption of 0.68 l diesel per 1 tonne waste was included corresponding to a garden waste shredding process (adapted from [6]).

For the main treatment technologies such as composting and waste incineration as well as for compost and digestate use on land and biomass transport (in the scenarios with land application), the default inventories available in EASETECH were used. For composting, a windrow composting plant in Aarhus (Denmark) with average values regarding volatile solid (VS) degradation and material loss due to compost screening was reflected. For incineration, a generic waste incinerator in Denmark with net electricity production of 22% and heat recovery of 73% was used. For compost and digestate use on land, air emissions of N<sub>2</sub>O and NH<sub>3</sub>, NO<sub>3</sub> runoff to surface water and leaching to ground water as well as heavy metal loading to the soil were covered. For the biomass transport, a conventional truck available in the database was used and a distance of 25 km was set.

For garden waste treatment in AD and direct use on land, own inventories were constructed. For AD, a mesophilic plant with methane yield of 76% of the biogas potential, gas leaking from the digester of 3% and a biogas engine with 40% electricity and 50% heat efficiencies was reflected; corresponds to the case shown by [6] and [7]. To model garden waste direct use on land, emission factors from [8] were considered.

The composition of the input garden waste included 55% total solids (TS), VS of 34% of TS, lower heating value of 8 MJ/kg TS and a methane potential of 35 m<sup>3</sup> CH<sub>4</sub> per tonne (wet weight) which corresponds to the waste that was used for the pre-treatment technology investigation.

#### 4. Results

Based on the results derived in this study (Figure 1), one specific scenario could not be identified as the best. For Global Warming, the two scenarios designed for energy recovery (AD and incineration) had impact savings while the treatments focused on nutrient recovery (composting and direct use on land) only resulted in impact loads. The savings for incineration were larger than for AD due to a relatively high calorific value of garden waste exceeding the energy content of the biogas produced, i.e. more energy was substituted in the incineration case. With the alternative electricity marginals, the magnitude of the difference between the two scenarios was, however, less pronounced. For the impact category reflecting use of fossil resources, the same trend as for Global Warming was observed. For photochemical ozone formation, the ranking was opposite and the biggest impact load was in the scenario with incineration. Contribution to marine eutrophication was important for all the scenarios with biomass use on land and was insignificant for the incineration where no land application was intended. For acidification and terrestrial eutrophication, a pronounced impact load in the composting scenario was observed which was due to volatilization of ammonia from the facility.

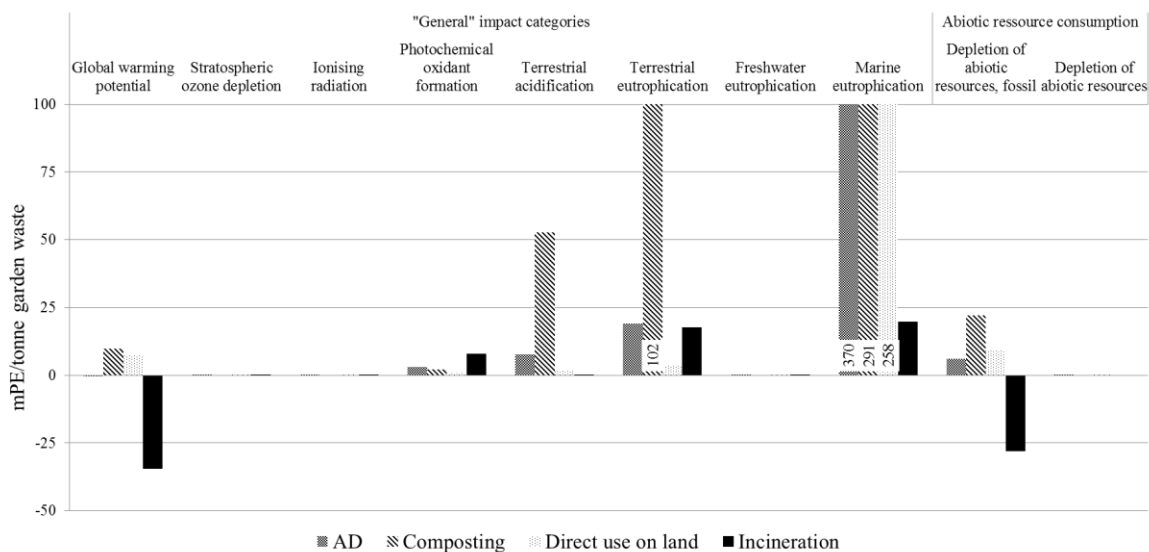

Figure 1: LCA results for “general” impact categories and abiotic resource consumption; net values are shown. To improve resolution of the figure some of the columns were truncated

#### 5. Conclusion

The study showed that there is no one garden waste treatment option best for the all the impact categories simultaneously. In this light, to make a choice between the treatment methods weighting of each category in a specific context needs to be implemented.

#### 6. References

[1] European Commission, Joint Research Centre - Institute for Environment and Sustainability, ‘International Reference Life Cycle Data System (ILCD) Handbook- Recommendations for Life Cycle Impact Assessment in the European context. First edition November 2011. EUR 24571 EN’, Luxembourg, Publications Office of the European Union, 2011.

- [2] Clavreul, J., Baumeister, H. & Christensen, T. H., 'An environmental assessment system for environmental technologies', *Environmental Modelling and Software* 60 (2014) 18-30.
- [3] Fruergaard, T., Astrup, T., Ekvall, T., 2009. Energy use and recovery in waste management and implications for accounting of greenhouse gases and global warming contributions. *Waste Manag. Res.* 27 (2009) 724–737.
- [4] Mathiesen, B.V., Münster, M., Fruergaard, T., 'Uncertainties related to the identification of the marginal energy technology in consequential life cycle assessments', *J. Clean. Prod.* 17 (2009) 1331–1338.
- [5] NaturErhvervsstyrelsen, 'Vejledning om gødsknings- og harmoniregler. Planperioden 1. august 2014 til 31. juli 2015', Ministeriet for Fødevarer, Landbrug og Fiskeri, 2015.
- [6] Jacobsen, J.B., Møller, J., Kromann, M., Neidel, T.L. & Jensen, M.B., 'Miljø- og samfundsøkonomisk vurdering af muligheder for øget genanvendelse af papir, pap, plast, metal og organisk affald fra dagrenovation', Miljøprojekt nr. 1458, Miljøstyrelsen, 2013.
- [7] Carlsson, M., Holmström, D., Lagerkvist, A. & Bisailon, M., 'Förbehandling av biogassubstrat i systemanalys', Waste Refinery, SP Sveriges Tekniska Forskningsinstitut, Borås, 2013.
- [8] Bruun, S., Hansen, T. L., Christensen, T. H., Magid, J. & Jensen, L. S., 'Application of processed organic municipal solid waste on agricultural land – a scenario analysis'. *Environmental Modeling & Assessment* 11 (2006) 251-265.

# Comparing Water Footprint impact methods: a case study on biogas production from energy crops

Tommaso Pacetti<sup>1</sup>, Enrica Caporali<sup>1</sup>, Laura Zanchi<sup>2</sup>, Giorgio Federici<sup>1</sup>

<sup>1</sup> University of Florence, Department of Civil and Environmental Engineering

<sup>2</sup> University of Florence, Department of Industrial Engineering

E-mail contact: [tommaso.pacetti@unifi.it](mailto:tommaso.pacetti@unifi.it)

## 1. Abstract

*Water use is generally considered a relevant issue to be necessarily included in the sustainability analysis. Water footprint indicators, whose aim is to identify water hotspots, represent the attempt to assess potential environmental impacts of water use (either consumptive or degradative) in a life cycle perspective. We hereby present results and reflections stemmed from the water footprint analysis of bioenergy produced by energy crop. The aim of this study was to test and compare the available methodologies for water scarcity footprinting, evaluating their behaviour and capability to identify hotspots in terms of water scarcity. Outcomes from this work can give an interesting overview useful for selection of Water Footprint impact methods for further case studies.*

## 2. Introduction

Sustainable water management and the characterization of all the involved processes are directly connected with the definition of sustainability.

Recently the definition of Nexus [1] has introduced an innovative framework that can promote a deeper understanding of the interactions between water, energy and food.

Several approaches have been developed in the last years to assess water use, starting from the definition of virtual water made by Allan [2] as the water needed to produce and process a commodity or service.

Hoekstra and Hung of the UNESCO-IHE Institute for Water Education were the first to transform Allan's idea into quantifiable models [3] and Water Footprint (WF) indicators

The method defined by Hoekstra [4] in the WF assessment manual, is composed by a four-step approach, including setting goals and scope, water footprint accounting, sustainability assessment and response formulation. The accounting phase includes the quantification and mapping of freshwater use with three distinct types of water use: i) blue water, defined as the fresh surface or groundwater use; ii) grey water, related to water pollution; iii) green water, defined as the rainwater that does not become runoff.

In addition, the guideline standard ISO 14046 [5] recently determined the entrance of water footprinting in the Life Cycle Assessment (LCA) framework.

The WF-LCA methodology allows getting a better understanding of the full life cycle of a product in terms water use. The result of a water footprint assessment is a single value or a profile of impact indicators, assessing water quantity and quality issues [5].

## 3. Case study

The biogas production from anaerobic digestion of energy crops in central Italy represents an interesting application. In fact, the increasing diffusion of biogas production from energy crops generates concerns about potential negative effects on the environment, on competition in the food market as well as about the

progressive changes in land use. The main goal of the study is to analyze the nexus between bioenergy production and water, which plays a key role because water resources are often the limiting factor in energy production from crops. The use of the last developed water footprinting methods represent an innovative assessment of the impact of biogas production on water.

Three kinds of crops - maize, sorghum and wheat - were selected, being the most widespread in the Italian territory for bioenergy production.

The functional unit chosen is *1 GJ* of energy content in the biogas from the anaerobic digestion; the system boundaries includes crop cultivation, digestion and energy conversion steps, along with energy and materials needed for these phases and direct emissions. More details about the case study are reported in [6]

#### 4. Methodology description

Among other LCA indicators, WF indicators for water scarcity are particularly time/space sensitive and the analysis must focus on local scale. Currently there are several methods available to assess water scarcity, which differ in terms of granularity and characterization factors.

Three different methods have been utilized in the study: Boulay [7], Hoekstra [8] and Pfister [9].

They use midpoints indicators based on different expressions of regional water scarcity: Boulay and Hoekstra are based on consumption to availability approach (CTA=annual water consumption/annual availability), while Pfister uses the withdrawal to availability ratio (WTA=annual water withdrawal/annual availability) in the characterization phase. Moreover, the three methods differ in the way the Water Scarcity Index-WSI (i.e. characterization factor in WF) is estimated, as reported in tab.1

<p><b>BOULAY et al</b> <b>2011 [7]</b></p>	$WSI = \sum_i (\alpha_i \times V_{i,in}) - \sum_i (\alpha_i \times V_{i,out})$ <p>where WSI = Water scarcity index  <math>\alpha</math> = characterization factors defined as follow  <math>\alpha_{surface,j} = \frac{CU \times (1 - f_p)}{Q_{90}} \times P_i</math>    <math>\alpha_{GW,i} = \frac{CU \times f_p}{GWR} \times P_i</math></p>	
<p><b>HOEKSTRA et al</b> <b>2011 [8]</b></p>	$WS_{blue}[x, t] = \frac{\sum WF_{blue}[x, t]}{WA_{blue}[x, t]}$ <p>where <math>WS_{blue}[x, t]</math> = Blue water scarcity (at time <math>t</math> and location <math>x</math>)  <math>WF_{blue}</math> = blue water footprint  <math>WA_{blue}</math> = blue water availability</p>	
<p><b>PFISTER et al</b> <b>2009 [9]</b></p>	$WSI = \frac{1}{1 + e^{-6.4 WTA \left( \frac{1}{0.01} - 1 \right)}}$ <p>where WSI = Water scarcity index  WTA = withdrawal to availability ratio</p>	

Table 1: Water scarcity footprinting methods

#### 5. Results

The results of water scarcity assessment (fig.1) show that all methods recognize the wheat as the less sustainable in term of water use. One of the most affecting element is the yield value which was found lower for the wheat than for maize and sorghum (e.g. for the production of the same amount of biogas, a larger cultivated surface is required). However, the WF absolute value of each cultivation differs considerably, depending on the method adopted: Hoekstra method gives values almost double of the other two. This is due to the different calculation assumptions and the different WSI databases.

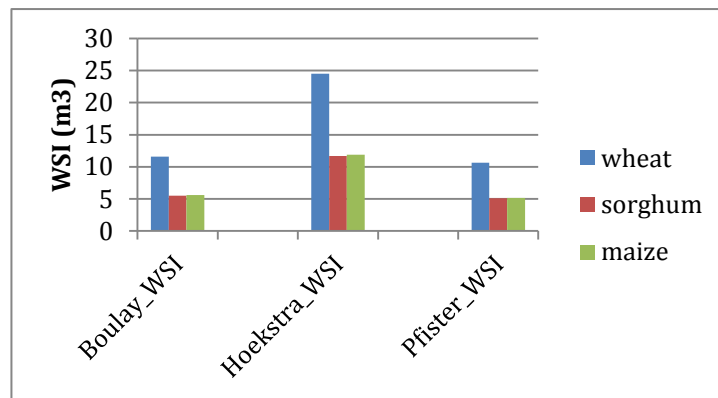

Figure 1: Water scarcity footprint results

Four aspects have been taken into account for the sensitivity analysis: crops productivity (reduced by 28%), biogas yield of crops (reduced by 12%), CHP efficiency (heat recovery equal to zero). Results (tab.2) show that although Boulay method is slightly more sensitive to parameters variation, the performances of the methods in terms of sensitivity are equal.

<b>Biogas production sensitivity</b>					
Impact category	Unit	Sensitivity result	standard	Absolute variation	Relative variation
Boulay_WSI	m3	13.18	11.58	1.60	13.87%
Hoekstra_WSI	m3	27.89	24.49	3.39	13.86%
Pfister_WSI	m3	12.13	10.65	1.47	13.86%
<b>Yield sensitivity</b>					
Impact category	Unit	Sensitivity result	standard	Absolute variation	Relative variation
Boulay_WSI	m3	16.29	11.58	4.71	40.69%
Hoekstra_WSI	m3	34.46	24.49	9.96	40.68%
Pfister_WSI	m3	14.99	10.65	4.33	40.68%
<b>CHP efficiency sensitivity</b>					
Impact category	Unit	Sensitivity result	standard	Absolute variation	Relative variation
Boulay_WSI	m3	11.62	11.58	0.038	0.34%
Hoekstra_WSI	m3	24.57	24.49	0.078	0.32%
Pfister_WSI	m3	10.69	10.65	0.033	0.32%

Table 2: Sensitivity analysis

## 6. Conclusion

The performances of three Water Footprint impact methods were analysed through a specific case study on biogas production from the anaerobic digestion of energy crops.

These methods share the same qualitative results but they differ in quantitative terms due to different assumptions and WSI databases. Even though all the methods show the capability to identify water scarcity hotspots, their variability in results suggest the importance of selecting the most appropriate one and even presenting a comparison of them in order to get comprehensive results for water scarcity assessment in agrifood sector.



## 7. References

- [1] SEI (Stockholm Environment Institute), (2011), Understanding the Nexus Background paper for the Bonn 2011 Nexus Conference
- [2] Allan, J.A., 1997. "Virtual Water": a Long Term Solution for Water Short Middle Eastern economies?, 1997 British Association Festival of Science, Water and Development Session - TUE.51, 14.45, 9 September 1997
- [3] Hoekstra, A.Y. & Hung, P.Q. (2003) "Globalisation of water resources: international virtual water flows in relation to crop trade" *Global Environmental Change*, No. 15: 45–56.
- [4] Hoekstra, A.Y., Chapagain, A.K., Aldaya, M.M., Mekonnen, M.M., (2011). *The WaterFootprint Assessment Manual*. Febrero 2011.
- [5] ISO 14046:2014 Environmental management -- Water footprint -- Principles, requirements and guidelines
- [6] Pacetti, T., Lombardi, L., & Federici, G. (2015). Water–energy Nexus: a case of biogas production from energy crops evaluated by Water Footprint and Life Cycle Assessment (LCA) methods. *Journal of Cleaner Production*.
- [7] Boulay, A.M., Bulle, C., Bayart, J.B., Deschenes, L., Margni, M. (2011). Regional Characterization of Freshwater Use in LCA: Modeling Direct Impacts on Human Health. *Environmental Science & Technology* 45: 8948-8957
- [8] Hoekstra AY, Mekonnen MM, Chapagain AK, Mathews RE, Richter BD (2012) Global Monthly Water Scarcity: Blue Water Footprints versus Blue Water Availability. *PLoS ONE* 7(2): e32688
- [9] Pfister, S.; Koehler, A.; Hellweg, S. (2009). Assessing the environmental impacts of freshwater consumption in LCA. *Environmental Science and Technology*, 43(11), 4098–4104

# **Environmental assessment of electricity generation from anaerobic digestion of agricultural waste**

*Jacopo Bacenetti<sup>1</sup>, Alessandra Fusi<sup>2</sup>, Marco Fiala<sup>1</sup> and Adisa Azapagic<sup>2</sup>*

*<sup>1</sup>Department of Agricultural and Environmental Sciences, Production, Landscape, Agroenergy,  
Università degli Studi di Milano, Via G. Celoria 2, 20133 Milan, Italy.*

*<sup>2</sup>School of Chemical Engineering and Analytical Science, The Mill, Sackville Street, The University of Manchester,  
Manchester, M13 9PL, United Kingdom.*

*E-mail contact: [jacopo.bacenetti@unimi.it](mailto:jacopo.bacenetti@unimi.it)*

## **1. Abstract**

*In this study, the environmental impacts associated with the generation of electricity from anaerobic digestion (AD) of agricultural waste have been evaluated using life cycle assessment. Four AD plants are considered with the installed capacity ranging from 100 to 300 kW. They are fed with agricultural waste, such as animal slurry, potato peel, tomato skin and seeds, and a small amount of maize silage. The results suggest that the plants fed with waste and maize silage have higher impacts than those using only waste.*

## **2. Introduction**

In Europe, residues from agri-food activities, such as animal waste, wineries, tomato and fruit processing, are usually not valorised and represent an added cost for companies associated with waste disposal and related environmental issues [1]. A possible solution is the production of biogas in AD plants and its use to generate electricity.

Environmental benefits from the use of agricultural feedstock for AD have been highlighted by many authors [2-7]. However, most studies focus on AD plants fed mainly with energy crops and cereal silage [2-3,6] so that the potential benefits of using agricultural waste are currently largely unknown. Therefore, this study sets out to explore the environmental implications of utilizing waste feedstocks to generate electricity from biogas produced by AD.

## **3. Methodology**

Life cycle assessment (LCA) has been used to estimate the environmental impacts of electricity generation from agro-food wastes, as detailed bellow. The LCA methodology follows the ISO 14040 guidelines [8].

### *3.1 Goal and Scope*

The aim of this study is to evaluate the environmental impacts associated with generation of electricity from biogas produced by AD of agricultural waste. Four real AD plants (A, B, C and D) are considered, with the installed capacity ranging from 100 to 300 kW. They are fed with animal slurry, potato skins, tomato seeds and skins; some plants also use maize silage. As indicated in Figure 1, the system boundary is from ‘cradle to grave, comprising feedstock production/recovery and storage, biogas production and conversion to electricity, digestate management and construction of the AD plant. The functional unit is defined as “generation of 1 kWh of electricity to be fed into the grid”.

## 2.2 Inventory Data

Data have been obtained from four AD plants located in Lombardy. As detailed in Table 1, each plant has two digesters of different capacity; their installed electrical capacity also differ as do their feedstocks. Data for the manufacture of the AD plants have been sourced from Ecoinvent [9] and a scaling factor has been used to adapt the data to the capacity of the actual plants considered in the study [10]. The emissions associated with methane combustion and digestate management have been calculated based on [11-12].

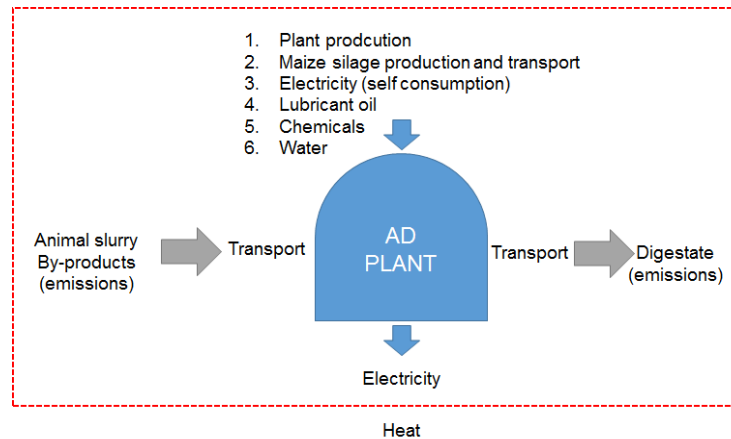

Figure 1: System boundary

Parameter	Unit	AD PLANT				
		A	B	C	D	
Digester capacity	m <sup>3</sup>	1650 + 2000	2550+ 2750	1885 + 2000	2000 + 2200	
Installed electrical capacity	kW	230	300	100	100	
Electricity production	MWh/y	1945	2429	781	835	
Electricity consumption by plant	MWh/y	173	206.5	85.9	91.8	
Pig slurry	Amount	t/year	14600	15330	-	17520
	Transport distance	km	1.02	3.02	-	0.80
Cow slurry	Amount	t/year	-	-	16425	-
	Transport distance	km	-	-	0.1	-
Maize silage	Amount	t/year	-	5475	-	1095
	Transport distance	km	-	0.85	-	-
Tomato skin and seeds	Amount	t/year	2920	-	-	-
	Transport distance	km	20.5	-	-	-
Potato peel	Amount	t/year	1825	-	-	-
	Transport distance	km	25.3	-	-	-
Water	t/year	1900	1825	-	-	
Lubricating oil for CHP	kg/y	1338	1282	423	452	
Chemicals for desulphurisation	kg/year	68	76	42	44	

Table 1: Inventory data

## 4. Results

The environmental impacts have been estimated using the ILCD method [12]. The following impact categories are considered: Climate change (CC), ozone depletion (OD), Human toxicity (HC), photochemical oxidant formation (POF), acidification (AP), terrestrial eutrophication (TE), freshwater eutrophication (FE), marine eutrophication (ME), freshwater ecotoxicity (FET) and mineral, fossil and resources depletion (MFRD). Figure 2 compares the impacts for the four AD plants.

Generally, higher impacts are found for the plants fed with maize silage while the best options are those using animal slurry as a feedstock. Therefore, Plant B, fed by pig slurry and maize silage, has the highest impacts for all the categories considered, while plants A and C, using only waste, represent the best options. As shown in Table 2, digestate emissions are the hotspot for CC; plant construction for HT, FE and MFRD; biomass transport for MFRD; and materials and energy consumptions for OD, POF and ME. Maize silage, where used (plants B and D), is the main cause of most impacts, contributing from 48%-96%.

## 5. Conclusions

The goal of this study was to estimate and compare the environmental impacts of different AD plants utilizing agricultural waste with a small amount of maize silage to generate electricity from biogas. The results indicate that using only waste has lower environmental impacts than waste combined with maize silage. For example, the CC impact from Plant A using waste only is equal to 0.3 kg CO<sub>2</sub> eq./kWh while from Plant B, utilizing maize silage, is 0.4 kg CO<sub>2</sub> eq./kWh.

	Plant	Contributions to impacts (%)									
		CC	OD	HT	POF	AP	TE	FE	ME	FET	MFRD
AD plant manufacturing	A	3.36	6.12	76.68	6.66	3.59	2.35	69.66	7.29	48.95	42.35
	B	3.42	4.75	60.36	4.57	0.79	0.44	2.39	2.61	1.98	22.41
	C	3.34	6.62	84.31	7.28	3.55	2.42	80.79	8.07	53.39	74.89
	D	2.90	4.23	62.64	4.39	0.96	0.54	3.25	2.94	2.69	25.43
Materials and energy consumption	A	16.69	71.28	6.10	34.59	26.45	11.07	11.49	35.85	11.51	7.96
	B	12.99	41.75	3.61	17.93	4.46	1.58	0.30	9.83	0.35	3.21
	C	20.39	92.20	7.93	45.47	32.03	14.00	15.91	48.72	15.18	16.95
	D	17.70	59.00	5.90	27.47	8.63	3.15	0.64	17.74	0.77	5.76
Biomass production and storage	A	0.00	0.01	0.00	0.00	0.00	0.00	0.00	0.00	0.00	0.01
	B	19.57	47.59	26.67	48.24	82.65	85.33	96.64	73.04	96.31	57.29
	C	0.00	0.00	0.00	0.00	0.00	0.00	0.00	0.00	0.00	0.00
	D	12.01	30.71	19.97	33.64	72.28	76.80	95.05	59.42	94.33	46.70
Emissions from biogas combustion	A	0.90	0.00	6.05	19.05	3.65	5.77	0.00	19.06	27.17	0.00
	B	0.74	0.00	3.84	10.49	0.65	0.86	0.00	5.49	0.89	0.00
	C	0.90	0.00	6.65	20.82	3.61	5.94	0.00	21.10	29.63	0.00
	D	0.78	0.00	4.94	12.57	0.97	1.33	0.00	7.68	1.49	0.00
Emissions from digestate storage	A	75.67	0.00	0.00	22.88	61.12	74.92	0.00	18.48	0.00	0.00
	B	61.80	0.00	0.00	12.60	10.82	11.21	0.00	5.32	0.00	0.00
	C	75.16	0.00	0.00	25.01	60.40	77.17	0.00	20.46	0.00	0.00
	D	65.18	0.00	0.00	15.10	16.27	17.34	0.00	7.44	0.00	0.00
Biomass transport	A	3.37	22.59	11.18	16.81	5.18	5.88	18.85	19.31	12.37	49.68
	B	1.47	5.92	5.52	6.17	0.64	0.59	0.68	3.70	0.47	17.09
	C	0.21	1.19	1.11	1.42	0.41	0.47	3.30	1.65	1.80	8.16
	D	1.43	6.06	6.56	6.83	0.88	0.84	1.06	4.78	0.72	22.11

Table 2: Contribution of different life cycle stages to the environmental impacts of AD plants

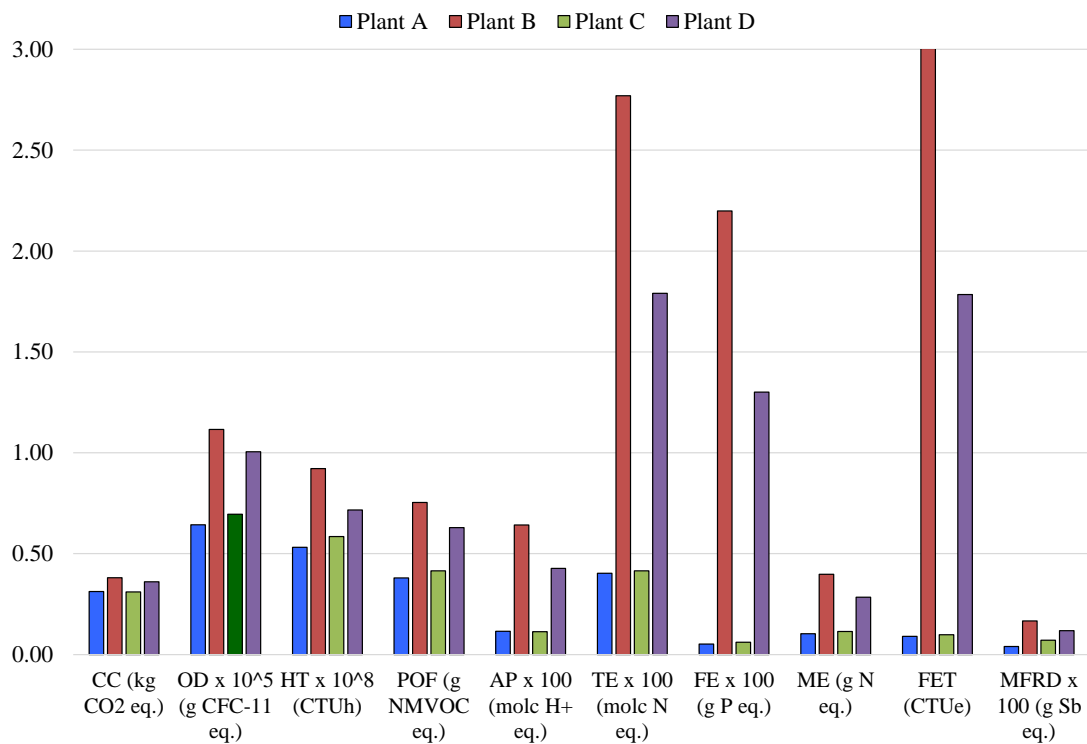

Figure 2: Environmental impacts of different AD plant options

## References

- [1] Bacenetti J, Duca D, Fusi A, Negri M, Fiala M. Mitigation strategies in the agro-food sector: the anaerobic digestion of tomato puree by-products. An Italian case study. *Sci Total Environ* 526 88-97.
- [2] Bacenetti, J., Negri, M., Fiala, M., Gonzalez Garcia S., (2013), Anaerobic digestion of different feedstock: impact on energetic and environmental balances of biogas process, *Sci Total Environ* 463-464.
- [3] Dressler D., Loewen A., Nelles M., (2012), Life cycle assessment of the supply and use of bioenergy: impact of regional factors on biogas production. *Int J LCA* 17 1104-1115.
- [4] Lansche J., Müller J., (2012), Life cycle assessment of energy generation of biogas fed combined heat and power plants: Environmental impact of different agricultural substrates. *Eng Life Sci.* 12 313-320.
- [5] Lijó, L., González-García, S., Bacenetti, J., Fiala, M., Feijoo, G., Lema, J.M., Moreira, M.T., (2014), Life cycle assessment of electricity production in Italy from anaerobic co-digestion of pig slurry and energy crops, *Renewable Energy* 68 625-635.
- [6] Lijó, L., González-García, S., Bacenetti, J., Fiala, M., Feijoo, G., Moreira, M.T., (2014), Assuring the sustainable production of biogas from anaerobic mono-digestion, *J Cleaner Prod* 72 23-34.
- [7] Whiting, A., Azapagic, A., (2014), Life cycle environmental impacts of generating electricity and heat from biogas produced by anaerobic digestion *Energy* 70 181-193.
- [8] ISO (2006), ISO 14040-environmental management - life cycle assessment – principles and framework. ISO, Geneva.
- [9] Jungbluth, N. et al. (2007), Life Cycle Inventories of Bioenergy. ecoinvent report No. 17, Swiss Centre for Life Cycle Inventories, Dübendorf, CH.
- [10] Coulson, J.M., J.F. Richardson, R.K. Sinnott (1993), *Chemical engineering design*. Butterworth-Heinemann, Oxford.
- [11] IPCC (2007). *Agriculture, Forestry and Other Land Use*. IPCC Guidelines for National Greenhouse Gas Inventories.
- [12] Wolf, M.A., Pant, R., Chomkamsri, K., Sala, S., Pennington, D. (2012), *ILCD handbook - towards more sustainable production and consumption for a resource efficient Europe*. JRC Reference Report.

# LCA and Water Footprint of biofuels used in transport sector: a review

Paola Masotti<sup>1</sup>, Barbara Campisi<sup>2</sup> and Paolo Bogoni<sup>2</sup>

<sup>1</sup>University of Trento, Department of Economics and Management, via Inama 5, 38122 Trento

<sup>2</sup>University of Trieste, Department of Economic, Business, Mathematical and Statistical Sciences,  
via Valerio 6, 34127 Trieste

E-mail contact: [paola.masotti@unitn.it](mailto:paola.masotti@unitn.it)

## 1. Abstract

*Concerns over energy security and environmental impacts related to greenhouse gases emissions stimulate developments towards renewable energy. Over the last few years, there has been an intense debate about the major factors that determine the impacts of biofuels both in production and end use phase. The objective of this study is to review existing life cycle assessment (LCA) and water footprint (WF) studies on liquid biofuels used in transport sector to point out if: (i) LCA studies are adequate to evaluate the environmental impacts of biofuels; (ii) biofuels are environmentally sustainable when the WF is considered; (iii) it is possible to use both LCA and WF studies results to better assess the environmental sustainability of biofuels. Furthermore, different aspects of crops production are considered to assess the efficiency of the biofuels in the greenhouse gas emission reduction. The analysed LCA papers present quite different and at times contradictory results on biofuel environmental impacts. Variability in results is affected by crops used and geographical areas of cultivation and, consequently, the impact assessment of biofuels is consistent only at the local level. In conclusion, it can be stated that territory characteristics, weather conditions and farming methods should be considered to evaluate biofuels production.*

## 2. Introduction

Many countries have established regulatory policies to promote the production or consumption of biofuels for transport. For example, in the European Union transport sector is expected to switch from fossil fuel use to a fuel mixture with 10% fraction of biofuels by 2020. As a result, global biofuel production grew from 16 billion litres in 2000 to more than 117 billion litres (volumetric) in 2013 [1]. At the same time, biofuels have to be produced in a sustainable way to reduce greenhouse gas (GHG) emissions without adversely affecting the environment or social sustainability. Over the last few years, there has been an intense debate about the major factors that determine the impacts of biofuels both in production and end use phase. Growing crops for biofuels may have serious environmental impacts such as direct or indirect land-use changes, soil degradation, nutrient depletion, loss of biodiversity, water depletion and pollution [2]. To determine and evaluate the environmental impacts of biofuels many studies have been carried out applying the life cycle analysis (LCA) methodology [3, 4, 5, 6] but only few take into account water use/consumption [7, 8]. In recent years a number of studies investigated the issue of water consumption for crops used for the biofuels production pointing out that they have relatively high water requirements at commercial yield levels. Considering that fresh water for agriculture is becoming increasingly scarce in many countries as a result of the competition with domestic or industrial uses, the paper focuses on the impact of a larger consumption of biofuels on this vital resource.

## 2. Materials and methods

In this paper a literature survey on LCA and WF studies of liquid biofuels used in the transport sector, namely bio-ethanol and biodiesel, has been carried out covering a time period of ten years. Because of the large number of publications only review papers on LCA have been considered whereas both reviews and original research papers on WF have been examined.

## 3. Results

Nine review papers have been analysed to obtain a comprehensive knowledge of the LCA studies on the environmental impacts of biofuels in transport sector. The reviews agree in pointing out two major issues: (i) most of the analysed papers calculate or estimate the GHG emissions and the energy balance whereas only few consider other impact categories [9][10]; (ii) the wide range and uncertainty in LCA results [4][5][11] and also some contradictory results [12]. Parameters that influence the variability in results are related to the study's specificity (type of crop, agricultural practices, country of cultivation and fuel processed plants) as well as to the different assumptions and methodological choices used to model the life-cycle assessment. According to Larson [4] there are four main parameters responsible of the greatest variations and uncertainties into GHG-related LCA results: "the climate-active species included in calculation of equivalent GHG emissions, assumptions around N<sub>2</sub>O emissions, the allocation method used for co-product credits, and soil carbon dynamics". Other authors draw the same conclusion, e.g. Malça and Freire [13] state that in more recent LCA biodiesel studies, soil emissions (namely N<sub>2</sub>O and carbon emissions) "as well as different options for dealing with co-products (scenario uncertainty), have strong influence in the results" of GHG emissions.

The results of the examined reviews can be summarized as follows. As regards biodiesel, to achieve moderate GHG savings and a favourable energy balance with respect to fossil diesel, there are at least three parameters to be met. These are: high biomass yields, low fertilizers and pesticides inputs in agricultural practices, no land use change. Overall considered palm oil is recognized as the most efficient crop to produce biodiesel [14][15] if deforestation environmental impacts are not taken into account whereas biodiesel from rapeseed cultivated in East Europe accounts for the higher GHG emissions, even higher than fossil fuel diesel emissions [10].

As regards bio-ethanol, better results for GHG savings and energy balance net gain are estimated in relation to fossil fuel and biodiesel as well [16]. Bio-ethanol produced from sugarcane in tropical countries appears by far the most efficient biofuel both for climate protection and fossil fuel conservation perspective if the residues are used to run the processing plants.

Last but not least all the reviews point out the highly site-dependent results in GHG and energy balance and the great variation in methodological choices and parameter settings that lead to a wide range of results and recommend to identify guidelines or a standard methodology to carry out LCAs on biofuels.

To exceed the LCA study limits and better evaluate the environmental impacts of biofuels a further parameter has been evaluated: the water footprint (WF) that allows to calculate water requirements for crops cultivation and accounts for both direct and indirect water consumption [17]. The WF papers analysed come to very similar results, Gerbens-Leenes and co-authors [7][8] calculated the WF of different biofuels and

show that “is 70 to 400 times larger than the WF of a mix of energy from non renewable sources” and in a transition to biofuels scenario it is expected that the global annual biofuel WF will increase more than tenfold, from about 90 km<sup>3</sup>/year in 2005 to 970 km<sup>3</sup>/year in 2030 [17]. Furthermore, in a recent study on bio-ethanol WF Gerbens-Leenes and Hoekstra [18] state that producing bio-ethanol from maize is more favourable than using sugarcane, contrary to the results of LCA studies above mentioned. In a study comparing the WF of three biofuel crops (cassava, sugarcane, and oil palm) with other food crops in Thailand, Piyanon and Gheewala [19] show that a hectare of biofuel crop lands requires more water than a hectare of other food crops. Moreover is very important to assess the water consumption in relation to the hydrogeological conditions of the different regions [20].

#### 4. Conclusion

Combining results from LCA and WF studies on first generation biofuels, namely biodiesel and bio-ethanol, no conclusive results can be achieved on environmental advantages in their utilization. Major uncertainties in LCA studies derive from biomass feedstocks, energy inputs, location of crop cultivation and related yields, soil emissions and allocation procedure for co-products while in WFs papers two variables, crop water requirements and crop yields, explain the large variability of the results. Overall, this brief review shows that future studies on biofuels LCA have to take into account the WF because water scarcity may become the limiting factor for biofuel feedstock production in many regions [2].

#### 5. References

- [1] REN21 (Renewable Energy Policy Network for the 21st Century), 'Renewables 2014 Global Status Report', Available online at <http://www.ren21.net/REN21Activities/GlobalStatusReport.aspx>.
- [2] FAO, 'The state of food and agriculture. Biofuels: prospects, risks and opportunities', (FAO, Rome, 2008) 55-71. Available online at <http://www.fao.org/docrep/011/i0100e/i0100e00.htm>.
- [3] Hill, J., Nelson, E., Tilman, D., Polasky, S. and Tiffany D., 'Environmental, economic, and energetic costs and benefits of biodiesel and ethanol biofuels', *Proc Nat Acad Sci* 103 (30) (2006) 11206-11210.
- [4] Larson, E., 'A review of life-cycle analysis studies on liquid biofuel systems for the transport sector', *Energ Sust Develop* 10 (2) (2006) 109-126.
- [5] Cherubini, F. and Strømman, A. H., 'Life cycle assessment of bioenergy systems: State of the art and future challenges', *Bioresource Technol* 102 (2011) 437-451.
- [6] Elbehri A., Segerstedt A. and Liu P., 'Biofuels and the sustainability challenge: A global assessment of sustainability issues, trends and policies for biofuels and related feedstocks', (FAO, Rome, 2013).
- [7] Gerbens-Leenes, P.W., Hoekstra, A.Y. and van der Meer, Th., 'The water footprint of energy from biomass: A quantitative assessment and consequences of an increasing share of bio-energy in energy supply', *Ecol Econ* 68 (2009) 1052-1060.
- [8] Gerbens-Leenes, W., Hoekstra, A.Y. S. and van der Meer, T.H., 'The water footprint of bioenergy', *Proc Nat Acad Sci* 106 (25) (2009) 10219-10223.
- [9] Wu, M., Zhang, Z. and Chiu, Y., 'Life-cycle Water Quantity and Water Quality Implications of Biofuels', *Curr Sust Renew Energ Rep* 1 (2014) 3-10.
- [10] Menichetti, E. and Otto, M., 'Energy balance and greenhouse gas emissions of biofuels from a life-cycle perspective', in 'Biofuels: Environmental Consequences and Interactions with Changing Land Use', Proceedings of the Scientific Committee on Problems of the Environment (SCOPE) International Biofuels Project Rapid Assessment, Gummertsbach, September, 2008, (R.W. Howarth and S. Bringezu, editors, 2009) 81-109.
- [11] Hoefnagels, R., Smeets, E. and Faaij, A., 'Greenhouse gas footprints of different biofuel production systems', *Renew Sust Energ Rev* 14 (2010) 1661-1694.
- [12] Gnansounou, E., Dauriat, A., Villegas, J. and Panichelli, L., 'Life cycle assessment of biofuels: Energy and greenhouse gas balances', *Bioresource Technol* 100 (2009) 4919-4930.



- [13] Malça, J. and Freire, F., 'Life-cycle studies of biodiesel in Europe: A review addressing the variability of results and modeling issues', *Renew Sust Energ Rev* 15 (2011) 338-351.
- [14] Escobar, J.C., Lora, E.S., Venturini, O.J., Yáñez E.E., Castillo, E.F. and Almazan, O., 'Biofuels: Environment, technology and food security', *Renew Sust Energ Rev* 13 (2009) 1275-1287.
- [15] Majer, S., Mueller-Langer, F., Zeller V. and Kaltschmitt, M., 'Implications of biodiesel production and utilization on global climate - A literature review', *Eur J Lipid Sci Technol* 111 (2009) 747-762.
- [16] von Blottnitz, H. and Curran, M.A., 'A review of assessments conducted on bio-ethanol as a transportation fuel from a net energy, greenhouse gas, and environmental life cycle perspective', *J Clean Prod* 15 (7) (2007) 607- 619.
- [17] Gerbens-Leenes, P.W., van Lienden, A.R., Hoekstra, A.Y. and van der Meer, Th.H., 'Biofuel scenarios in a water perspective: The global blue and green water footprint of road transport in 2030', *Global Environ Chang* 22 (2012) 764–775.
- [18] Gerbens-Leenes, W. and Hoekstra, A.Y., 'The water footprint of sweeteners and bio-ethanol', *Environ Int* 40 (2012) 202-211.
- [19] Piyanon, K. and Gheewala, S. H., 'A Review of the Water Footprint of Biofuel Crop Production in Thailand', *J. Sustain Energy Environ* 4 (2013) 45-52.
- [20] Faist Emmenegger, M., Pfister, S., Koehler, A., de Giovanetti, L., Arena, A.P., and Zah, R., 'Taking into account water use impacts in the LCA of biofuels: an Argentinean case study', *Int J Life Cycle Assess* 16 (2011) 869–877.

# **Simplified LCA tools: selected approaches assessed for their implementation in the agri-food sector**

*Ioannis Arzoumanidis<sup>1</sup>, Roberta Salomone<sup>2</sup>, Luigia Petti<sup>1</sup>, Andrea Raggi<sup>1</sup>*

*<sup>1</sup>Department of Economic Studies, University “G. d’Annunzio”,*

*Viale Pindaro 42, 65127 Pescara, Italy*

*<sup>2</sup>Department of Economic, Business, Environment and Quantitative Methods,*

*University of Messina, Piazza S. Pugliatti 1, 98122 Messina, Italy*

*E-mail contact: [a.raggi@unich.it](mailto:a.raggi@unich.it)*

## **1. Abstract**

*Life Cycle Assessment (LCA) has been increasingly used for the improvement of the environmental performance of goods and services, amongst which products belonging to the agri-food sector. Simplification of LCA was found to be important, especially for Small- and Medium-sized Enterprises (SMEs) that generally lack in resources. As a consequence, a number of simplification approaches and tools have been developed and proposed in the last decades, some of which for the agri-food sector. This paper builds on previous research performed in the wine sector where a set of simplified LCA approaches were identified and tested in the framework of an SME. Here, in order to advance and broaden the previous research and to evaluate the robustness of the results in the framework of the agri-food industry, two additional products were considered: roasted coffee and olive oil.*

## **2. Introduction**

Life Cycle Assessment (LCA) has been increasingly used for the improvement of the environmental performance of goods and services, amongst which products belonging to the agri-food sector [1, pp. 151–173]. Furthermore, simplification of LCA was found to be an important issue, especially for Small- and Medium-sized Enterprises (SMEs), where the necessary resources and knowledge needed for a full LCA are generally scarce. Consequently, a number of simplification approaches and tools have been proposed, some of which specifically for (or that can be used in) the agri-food sector.

This paper builds on previous research performed by the Authors in the wine sector, where a set of simplified LCA approaches were identified [1, pp. 123–150] and then tested and rated initially by expert users and then by non-expert ones [2-3]. The selection of the simplified approaches to be tested was performed by applying decision-making techniques (of the family of the Multi-Attribute Utility Theory) to the scores attributed to them by the users [1, pp. 123–150]. Subsequently, the selected simplified approaches were implemented in a case study in the framework of a small family-managed winery in Italy and the results were analysed in parallel to those of a full LCA [1 (pp. 151–173)-2].

By doing so, the strengths and weaknesses of the examined approaches were identified, not only in terms of the results obtained but also of the modelling that had to be used for each one of them. Here, in order to advance and broaden the previous research and to evaluate the robustness of the results in the framework of the agri-food industry, two additional products were considered (roasted coffee and olive oil) testing two

simplified LCA approaches: Bilan Produit (designed by ADEME France) and CCaLC (designed by the University of Manchester)<sup>13</sup>.

### 3. Roasted coffee

This case study was performed in the framework of the firm *Barbera 1870* (Messina, Italy). A cradle-to-grave analysis of this product using eVerDEE had already been published [1, pp. 303-330]. The functional unit (F.U.) was set as 1 kg of packaged roasted coffee. For this case study, no full LCA has been implemented until now.

#### 3.1 BilanProduit

The simplification of the tool BilanProduit [4] is at the level of Life Cycle Inventory (LCI) [2]. BilanProduit has recently developed a new version, which is directly available online [5], but still does not include a complete database (e.g., food production processes). For this reason, the old version [4], which was on a Microsoft Excel file, available only in French, was used. The same version of this tool was used as it happened for the case study of wine [1, pp. 151–173]. The sheets of the Excel file include the phases of production, transport, use, end of life, and, for every entry selected in the production sheet, the user needs to specify which phase in the life cycle it is connected to [2].

For the agricultural phase, the tool seemed to be lacking in entries related to fertilisers, limestone, pesticides, and land use. The emissions for the agriculture and packaging phases could not be inserted either. Regarding transport, the tool provided the possibility to insert separately: transport between plants, transport of packaging materials, and distribution. This kind of modelling, indeed, could separately provide the results per type of transport.

For this study, the phase of agriculture (mainly due to electricity consumption) appeared to be the most impacting one regarding most of the environmental impacts taken into consideration, such as climate change (0.389 kg CO<sub>2</sub> eq/F.U.), acidification (0.0041 kg SO<sub>2</sub> eq/F.U.) and eutrophication (1.17e-3 kg phosphate eq/F.U.).

#### 3.2 CCaLC

The simplification of the tool CCaLC [6] is at the level of Life Cycle Impact Assessment (LCIA) [2]. With respect to the previous work, a new version of the tool was available and thus was used (namely CCaLC2). In general, the incorporated database of the tool, which is integrated with a part of Ecoinvent 2 and 3, was found to be satisfactory for this study. However, it was lacking in some emissions and in land use entries (it did not include any data for the country where the agricultural phase takes place, i.e., Brazil).

The tool gives graphic results mainly for Carbon Footprint, but it also includes a set of other environmental impacts. Regarding climate change, the phase of agriculture (mainly due to the use of fertilisers) appeared to be the most impacting one (3.97 kg CO<sub>2</sub> eq/F.U.).

---

<sup>13</sup> The simplified tools taken into account in [2] were eVerDEE, Carbonostics, BilanProduit and CCaLC and the idea of the authors was to include all of them in this study, as well. Nevertheless, at the time when the present study was being prepared, Carbonostics was not available anymore and eVerDEE (available online) was under construction with its database not complete; they were thus excluded from the analysis here presented.

On the other hand, the use phase seemed to be the most contributing one for acidification (0.011 kg SO<sub>2</sub> eq/F.U.), eutrophication (7.37e-4 kg phosphate eq/F.U.), ozone layer depletion (4.7e-7 kg R11 eq/F.U.) and photochemical smog (7.05e-4 kg ethene eq/F.U.).

#### **4. Olive oil**

The case study on olive oil was performed in a *local association of oil producers* (APOM, Messina, Italy). A full LCA implementation to 9 different scenarios was published in [7]; for this paper, the scenario 6C was chosen (one of the most common in Italy). The F.U. was defined as 1000 kg of olives (which corresponds to 200 kg of olive oil). The system boundary included the phases of agriculture, olive oil production and olive oil mill waste treatment (composting).

##### *4.1 BilanProduit*

The database of the tool was lacking in entries, such as compost and straw. Moreover, as in the case of roasted coffee, emissions could not be inserted here. Since the system boundary did not include phases such as transport and end-of-life, only the “production” sheet was filled in. The results regarding climate change showed that the electricity consumption during the agricultural phase was the most impacting one (24490 kg CO<sub>2</sub> eq/F.U.), followed by the diesel consumption in the composting facility (4237 kg CO<sub>2</sub> eq/F.U.).

##### *4.2 CCaLC*

The tool provided with a built-in option to deal with the multifunctionality issue for the by-products (olive stones and compost), by using system expansion (in the same way as it was dealt with in the full LCA implementation [7]).

The results regarding climate change showed that the phase of composting was the most impacting one, due to diesel consumption by the machinery (3288 kg CO<sub>2</sub> eq/F.U.). The overall carbon footprint had a negative value (-1942 kg CO<sub>2</sub> eq/F.U.), due to the avoided production of fertilisers replaced by compost as a by-product. As far as the other environmental impacts are concerned, the sum of the raw materials used for all phases was the one that contributed the most.

#### **5. Conclusion**

The results confirmed the hypotheses made in the previous publications claiming that the use of different modelling (for meeting the needs of each tool), different databases and different environmental impact categories can lead to contrasting results. The characteristics of the product under study are also of essential importance for the selection of the most suitable simplified LCA tool. It was also found that the lack in agriculture-related processes within the incorporated databases can be of critical importance for agri-food products case studies, even though this could be the case also for conventional LCA analyses. As a general consideration, the tools examined demonstrated to be quite suitable, as regards modelling and reporting, for these agri-food products.

Future analysis will include the latest versions of eVerdEE and BilanProduit along with the implementation of the simplified tools in the framework of other agri-food products in order for more robust results to be obtained. In addition, full LCAs will be implemented for all the products under study.

## 5. References

- [1] Salomone, R., Clasadonte, M.T., Proto, M., Raggi, A. (Eds.), 'Product-Oriented Environmental Management System (POEMS)—Improving Sustainability and Competitiveness in the Agri-Food Chain with Innovative Environmental Management Tools', (Dordrecht, Springer, 2013).
- [2] Arzoumanidis, I., Raggi, A. and Petti, L., 'Considerations when applying simplified LCA approaches in the wine sector', *Sustainability*, 6(8) (2014) 5018-5028.
- [3] Arzoumanidis, I., Magazzeni, D., Petti, L. and Raggi, A., 'Selezione di uno strumento semplificato di LCA per il settore agroalimentare', *Proceedings of the 26th Italian Congress on Commodity Science*, Pisa, February, 2014, 61-68.
- [4] BilanProduit. Available online: [http://www.ademe.fr/internet/bilan\\_produit/login.asp](http://www.ademe.fr/internet/bilan_produit/login.asp) (accessed on 8 February 2014).
- [5] Base Impacts: BilanProduit. Available online: <http://www.base-impacts.ademe.fr/bilan-produit> (accessed on 10 June 2015).
- [6] CCaLC. Available online: <http://www.ccalc.org.uk/> (accessed on 30 May 2015).
- [7] Salomone, R. and Ioppolo, G., 'Environmental impacts of olive oil production: a Life Cycle Assessment case study in the province of Messina (Sicily)', *J. Clean. Prod.* 28 (2012) 88-100.

# **“Vernaccia di San Gimignano DOCG”: towards a sustainable wine farming**

Authors: Elena, Neri<sup>1</sup>; Riccardo Maria, Pulselli<sup>2</sup>; Federico Maria, Pulselli<sup>3</sup>; Nadia, Marchettini<sup>4</sup>

<sup>1,2</sup>INDACO<sub>2</sub> Srl spin-off, University of Siena, Italy

<sup>3,4</sup>Ecodynamics Group, DSFTA, University of Siena, Italy

E-mail contact: [elena.neri@indaco2.it](mailto:elena.neri@indaco2.it)

## **1. Abstract**

*The “Vernaccia di San Gimignano” is a white wine, the first to achieve the DOC label in Italy, in 1966. After about 50 years from that achievement, the Consortium “Denominazione San Gimignano” launched a project for promoting environmentally responsible wine-farming among its members. The first phase of the project involved four wine-farms to assess the average Carbon Footprint of one bottle of Vernaccia di San Gimignano (FU, 0.75 L) in order to highlight supply chain hotspots and best practices to put into effects. A minimum value of 0.60 kg CO<sub>2</sub>-eq and a maximum of 1.34 kg CO<sub>2</sub>-eq per FU were calculated, mainly due to the use of packaging materials. Main differences depend on the organization of farms, rather than their management (i.e. organic vs conventional). The application of best practices by farms would potentially allow for decreasing impacts of about 33%, in terms of Carbon Footprint.*

## **2. Introduction**

The “Vernaccia di San Gimignano” (hereafter VSG) achieved its DOC label (Denomination of Controlled Origin) in 1966, the first case in Italy. In 2014, after about 50 years from that achievement, the Consortium “Denominazione San Gimignano” [1], including (74) VSG wine producers (see fig.1), launched a project for promoting environmentally responsible wine-farming among its members. The project aims at assessing the Carbon Footprint (hereafter CF) of an average bottle of VSG, taking into account all supply chain processes and then identifying solutions and best practices to reduce impacts. The innovative aspect here is the participation of VSG winemakers in the Consortium (most of which have a family run winery) aimed at widely sharing objective and solutions towards a more sustainable production of VSG and potentially achieving a lower level of emission to be fully compensated by CO<sub>2</sub> absorption by farm ecosystems. The pilot phase of the project has been completed in December 2014.

## **3. Materials and method**

VSG is a fresh white wine made of grapes produced within the municipal territory of San Gimignano (near Siena, Tuscany) fig.1, according to Production Regulation [2]. Vineyards are composed of 85% VSG variety at least. The first four representative VSG wine farms (fig.1 in red) were selected according to the following criteria: management (2 organic and 2 conventional), estate dimensions (1 small, 2 medium, 1 big), supply chain completeness (i.e. all phases from vineyard to bottling were carried out within the farm boundaries) and location in the designed area for VSG production (in order to include the territorial variety).

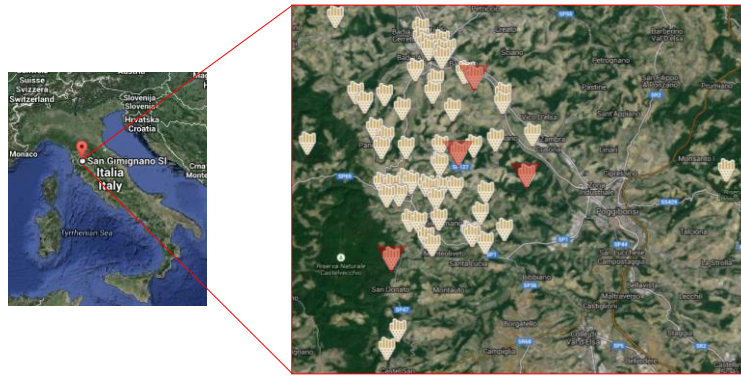

Figure 1: Geographical localization of four selected wine farms (in red)

All farms were VSG Production Regulation compliant, therefore their annual yield did not exceed 9000 kg per hectare and grapes were vinified (and wine aged) within the production area. The most part of vinification takes place in cooled tanks and wine is sold in bottles of 0.75 L (minimally as cask wine) . Farm#a and farm#b are two medium organic, while farm#c and farm#d are conventional wineries (small and big respectively).

All inventory data are gathered by direct interview with farmers, verifying all stages in farms. Allocation, where necessary, is conducted per mass. The Functional Unit (FU) is one bottle of VSG wine (0.75 L) produced in 2013 and the system boundaries are from cradle to the farm gate. The VSG supply chain is divided into three phases: vineyard maintenance (#1), wine production and ageing in cellar (#2) and bottling-packaging (#3). The analysis was performed with the SimaPro 7.3.3 software [3], selecting the method IPCC 2007 (100 yrs). Once assessed CO<sub>2</sub>-eq emissions for each farm per FU, a weighted average has been calculated on the basis of VSG bottles yearly produced by each farm, obtaining a VSG average bottle.

#### 4. Results and discussion

Results highlighted a minimum value of 0.60 kg CO<sub>2</sub>-eq for the medium organic farm#b and a maximum value of 1.34 kg CO<sub>2</sub>-eq for the big conventional farm#d, per FU (1 bottle=0.75 L) (fig.2).

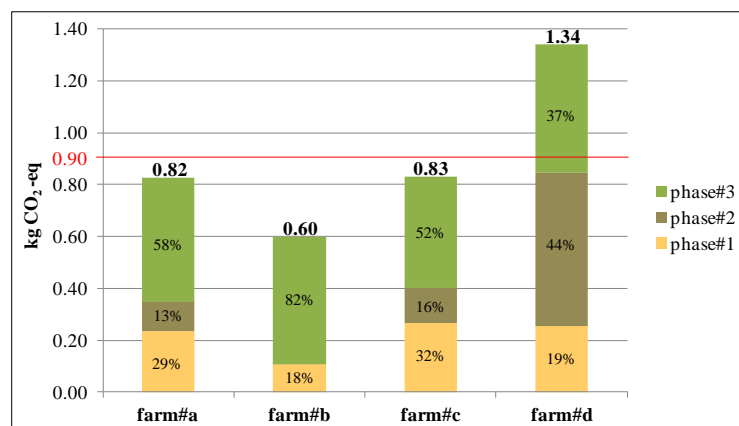

Figure 2: Carbon Footprint (kg CO<sub>2</sub>-eq) of four VSG wine bottles (0.75 L). Red line= VSG average bottle

Outcomes show that the phase#3 is the most relevant in terms of CF for farms#a, #b and #c (range between 0.43-0.49 kg CO<sub>2</sub>-eq per FU), mainly due to the use of packaging glass and boxes, followed by impacts for phase#1 (range from 0.11 to 0.27 kg CO<sub>2</sub>-eq per FU, farm#b and #c respectively), because of the use of chemicals (mainly copper based fungicides) and diesel consumption. Finally, emissions from phase#2 (range from 5.24E-4 to 0.13 kg CO<sub>2</sub>-eq per FU, farm#b and #c respectively) are linked to electricity consumption. Results for farm#d, the biggest (let's say semi-industrial production), highlight different percentages for the three phases. The most burdening is phase#2 (0.59 kg CO<sub>2</sub>-eq per FU) because of the huge quantity of electricity used for tank cooling, followed by phase#3 (0.49 kg CO<sub>2</sub>-eq per FU) and phase#1 (0.25 kg CO<sub>2</sub>-eq per FU). It is evident that the medium organic farm#b presents the best environmental performances, but also the farm#d performs virtuous processes.

Differences among the assessed wine-farms are based on the organization of the farm, rather than its management (i.e. organic vs conventional). This is demonstrated by the accomplishment of good-practices already in use, such as the installation of photovoltaic panels (farm#b) or the implementation of more efficient processes (e.g. collection of chemicals in surplus during the vineyard treatments, farm#d), with evident effects in terms of avoided impacts.

Results obtained in this study (e.g. the total CF value and the contribution of each phase to total impacts) are in line with those gathered in literature, referred to white wine supply chain (literature range: 0.6-1.64 kg CO<sub>2</sub>-eq per FU [4, 5, 6, 7, 8, 9, 10]).

Afterwards, the weighted mean value of 0.90 kg CO<sub>2</sub>-eq per FU was calculated based on results from the four sampled farms, thus tracing the environmental profile of an average VSG bottle. Moreover, the accomplishment of best practices detected in the four analysis (e.g. the use of photovoltaic panels, the collection of chemical surplus during treatments, lighter glass bottles), would potentially reduce impacts of about -33% of the total CF. The use of other container types for wine packaging (e.g. bag in box) may further reduce impacts.

## **5. Conclusion**

The environmental profile of VSG has been investigated based on LCA (even limited to the CF impact category [11]). The average CF of VSG is 0.90 kg CO<sub>2</sub>-eq per FU as resulted from the LCA of four representative winefarms. Outcomes show lower average impacts relative to other white wine productions in Italy. Considering the whole VSG supply chain, results demonstrated that impacts can be potentially decreased based on a few good practices such as saving of chemicals and fuels for vineyard maintenance, using renewable electricity in cellars, reducing materials for bottling and packaging. These would contribute to achieve a goal of -33% emission in terms of CF.

Next step of the VSG project will be the CF evaluation of a number of VSG winefarms by the end of 2016, in order to consolidate preliminary results and provide a robust assessment of VSG wine-farming. Sharing objectives and best practices among winemakers in San Gimignano would represent a concrete sustainable solution towards a low-emission production and an opportunity to promote sustainability as an added value in market oriented initiatives.



## 6. References

- [1] <http://www.vernaccia.it/> Accessed June 2015
- [2] <http://www.vernaccia.it/Vernaccia-di-San-Gimignano-D.O.C.G./PRODUCTION-REGULATIONS/> Accessed June 2015
- [3] PRé Consultants, 'SimaPro 7.3, LCA software. Amersfoort. The Netherlands', (2012), [www.pre.nl/simapro/default](http://www.pre.nl/simapro/default). Accessed June 2015
- [4] Benedetto, G. 'The environmental impact of a Sardinian wine by partial Life Cycle Assessment' *Wine Econ. and Pol.*, 2, (2013)33–41.
- [5] Fusi, A., Guidetti, R., Benedetto, R., 'Delving into the environmental aspect of a Sardinian white wine: from partial to total life cycle assessment' *Sci. Tot. Environ.* 472 (2014) 989-1000.
- [6] Vázquez-Rowe, I., Rugani, B., and Benetto, E., 'Tapping carbon footprint variations in the European wine sector'. *J. Clean. Prod.*, 43, (2013) 146–155.
- [7] Ardente, F., Beccali G., Cellura M., and Marvuglia, A. 'POEMS: A case study of an Italian wine-producing farm'. *Environ. Manage.*, 38(3), (2006) 350–364.
- [8] Gazulla, C., Raugei, M., and Fullana-i-Palmer, P., 'Taking a life cycle look at crianza wine production in Spain: Where are the bottlenecks?' *Int. J. LCA*, 15 (2010)330–337.
- [9] Rugani, B., Vázquez-Rowe, I., Benedetto, G., and Benetto, E., 'A comprehensive review of carbon footprint analysis as an extended environmental indicator in the wine sector'. *J. Clean. Prod.*, 54, (2013) 61–77.
- [10] Petti, L., Arzoumanidis, I, Benedetto, G., Bosco, S., Cellura, M., De Camillis, C., Fantin, V., Masotti, P., Pattara, C., Raggi, A., Rugani, B., Tassielli G. and Valein M., 'Life Cycle Assessment in the Wine Sector', in 'Life Cycle Assessment in the Agri-food Sector: Case studies, methodological issues and best practices', (Springer, 2015).
- [11] International Standard Organisation (ISO), 'ISO 14067 Greenhouses gases-carbon footprint of products requirements and guidelines for quantification and communication', (Geneva, 2013).

# Environmental impacts of the brewing sector: Life Cycle Assessment of Italian craft and industrial beer

Carlo Gavinelli<sup>1</sup>, Francesca Recanatì<sup>2</sup>, Giovanni Dotelli<sup>1</sup>

<sup>1</sup>Politecnico di Milano, Dip. Chimica, Materiali e Ingegneria Chimica “G. Natta”, p.zza L. Da Vinci 32, 20133 Milano

<sup>2</sup> Politecnico di Milano, Dip. Elettronica, Informazione e Bioingegneria, via Ponzio 34/5, 20133 Milano

E-mail contact: carlo.gavinelli@mail.polimi.it

## 1. Abstract

*European Union is the second largest beer producer in the world and environmental sustainability has become one of the pillars of its policies. This work aims to analyze the environmental performance of two different beer types: a representative beer of the European industry and an Italian craft beer. The environmental burdens are assessed through the LCA methodology, and the characterization methods used are CML-IA-baseline and ReCiPe Midpoint (H) V1.11 method.*

*The preliminary results show that the industrial beer is characterized by higher environmental performance. This general outcome is mainly evident in the GWP category: indeed, the hectoliter of industrial beer is responsible for the emission of 31.9 kg<sub>CO2eq</sub>, while 64.4 kg<sub>CO2eq</sub> are due to craft beer production. The higher efficiency of industrial processes represents the main contribution to the obtained results. It is mainly due to the lower energetic consumptions (both heat and electricity) and the use of sugar and additives in substitution of malted cereals.*

## 2. Introduction

In the last years, the European brewing industry has increasingly been paying attention on the environmental aspects of its products, so that beer is one of the pilot projects involved in the Product Environmental Footprint Category Rules (PEFCR) definition. LCA is the methodology on which this process is based. Given this context, this work attempts to preliminarily assess the environmental impacts of two different types of beer, using the Life Cycle Assessment methodology.

A first LCA is carried out to assess the environmental impacts of an European industrial beer: a representative beer has been modeled basing on the list of ingredients provided by the European Commission in the context of the PEFCRs. A second LCA is carried out to assess the environmental impacts of an Italian craft beer, brewed in a new Italian craft brewery. Locally produced barley and other local cereals (Carnaroli rice) are used in the recipe. In order to guaranteeing a consistent comparison, also the production site of the industrial beer is assumed to be located in northern Italy.

Finally, the two brewing approaches are compared in order to highlight which process aspects are relevant for the environmental sustainability.

## 3. Case studies

In both case studies the functional unit is one hectoliter (100 L) of beer produced in each brewery and ready to be bottled. A “cradle to the gate” approach has been chosen (i.e., the downstream module is excluded). The system boundaries of both case studies include the following unit processes: ‘Cereals cultivation’, ‘Malting process’, ‘Hops cultivation’, ‘Cleaners production’, ‘Sugar/Additives production’, ‘Brewing process’, ‘Transports’.

Straw, other products from the cereals cultivation (only grains are necessary for brewing operations) and brewers' spent grains (exhausted part of the malts and cereals from the filtration of the wort) are considered as co-products in both case studies. This multi-functionality problem has been solved using mass allocation criterion.

The existing PCR of the International EPD System (Carlsberg Italia S.p.a., 2013)<sup>1</sup> has been used as reference document to choose the potential environmental impact categories of the analysis.

Life Cycle Assessments are carried out through the software SimaPro 8.0.4.30. The impacts assessment methods selected are CML-IA baseline V3.01 and ReCiPe Midpoint (H) V1.11 (only water depletion category).

### 3.1 Representative European industrial beer

Industrial beer Life Cycle Inventory has been completed using only secondary and tertiary data: Agrifootprint database (mass allocation), Ecoinvent 3.1. database (allocation recycled content), data derived from PEF Pilot Beer list of ingredients (European Commission, 2014)<sup>2</sup>, data derived from American beer LCA study (The Climate CO2NSERVANCY, 2006)<sup>3</sup>, data derived from Italian rice LCA study (Blengini & Busto, 2008)<sup>4</sup>, average data from 2013 annual report by Assobirra (Assobirra, 2013)<sup>5</sup>.

### 3.2 Italian craft beer

Craft beer Life Cycle Inventory has been carried out mainly using primary data. In particular, data have been gathered for the cultivation of self-produced barley, barley malting in an Austrian malthouse, cultivation of Carnaroli rice, composition of the cleaning products and brewing process. On the other hand, secondary data have been used to complete the LCI requirements: Agrifootprint database (mass allocation units), Ecoinvent 3.1. database (allocation recycled content units), data derived from Italian rice LCA study (Blengini & Busto, 2008)<sup>4</sup>.

### 3.3 Results comparison

Results obtained from the Impact Assessment phase of the two case studies are shown in Table 1. Only the most relevant impact categories for this analysis are reported. Figure 1 and Figure 2 show the contribution to the total impacts of each unit process considered in the system boundaries.

<b>Impact category</b>	<b>Unit</b>	<b>Industrial</b>	<b>Italian craft</b>
Abiotic depletion (fossil fuels)	<i>MJ</i>	389.90	824.27
Global warming (GWP100a)	<i>kg CO<sub>2</sub> eq</i>	31.89	64.36
Human toxicity	<i>kg 1,4-DB eq</i>	6.66	10.38
Fresh water aquatic ecotox.	<i>kg 1,4-DB eq</i>	5.36	5.71
Marine aquatic ecotoxicity	<i>kg 1,4-DB eq</i>	12920.79	15247.57
Terrestrial ecotoxicity	<i>kg 1,4-DB eq</i>	0.16	0.13
Acidification	<i>kg SO<sub>2</sub> eq</i>	0.21	0.45
Eutrophication	<i>kg PO<sub>4</sub><sup>3-</sup> eq</i>	0.09	0.20
Water depletion	<i>m<sup>3</sup></i>	1.51	6.86

Table 1: LCIA numerical outcomes resulting from the two case studies analyzed

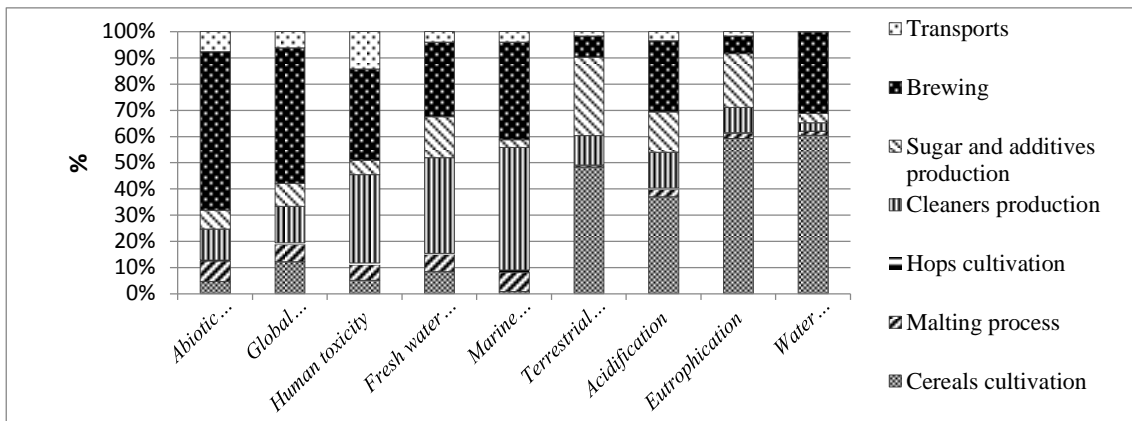

Figure 1: LCIA results of the representative industrial beer

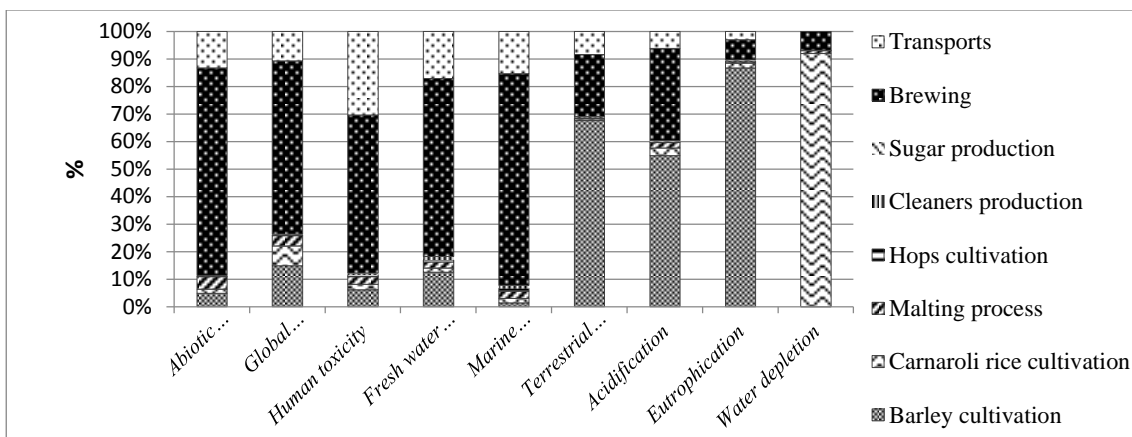

Figure 2: LCIA results of the Italian craft beer

Considering the comparison of the two case studies, the hectoliter of representative industrial beer is characterized by higher performances in all the impact categories considered, except for the ‘Terrestrial ecotoxicity’. Results concerning the ‘Abiotic depletion (fossil fuels)’, ‘GWP’ and ‘Water depletion’ categories show the most relevant discrepancies between the two case studies.

Concerning the GWP, Figure 1 and Figure 2 let emerge the relevant contributions of brewing process and cereals cultivation in both case studies (49% and 63% of the total emitted CO<sub>2</sub>eq. respectively). The production of sugar, additives and cleaners causes important fractions of impacts related to the industrial beer life cycle (more than 20% of the total GHGs emitted).

Impacts due to transportations have important contributions on the results of both case studies. Concerning the craft beer, the Austrian malting process is the main cause of emissions from transports (9.5% of the total emitted CO<sub>2</sub>eq.). The craft brewery has adopted this strategy to seek quality purposes, because the performance of the malting process guaranteed by the Austrian plant cannot today be guaranteed by any Italian malthouse. The presence of a similar malting plant nearby the brewery, would make the emissions significantly decrease (e.g., 5 kg CO<sub>2</sub>eq. avoided, considering a malthouse located 100 km from the brewery).

#### **4. Conclusion**

The two case studies analyzed in this work represent two different approaches in beer production and results obtained from the LCA analysis reflect the different strategies adopted in the production process.

In particular, the energetic consumption of the brewing plants play a relevant role in the environmental performances: 32 Mcal of thermal energy and 9 kWh of electric energy are required to produce one hectoliter of industrial beer, while 89 Mcal of thermal energy and almost 21 kWh of electricity are required to produce the craft beer. Consequently, the craft beer causes a GWP two times higher than the one caused by the industrial ones. Moreover, the different recipes used in the two processes further contribute to the discrepancies in the results: the hectoliter of representative industrial beer is produced using 14.25 kg of cereals (i.e., 9 kg of German barley, about 3 kg of German wheat and about 2 kg of other cereals) and 3.31 kg of sugar and additives (i.e. caramel, glucose syrup), while the hectoliter of craft beer is produced using 25.2 kg of cereals (i.e. 22.5 kg self-produced barley, 0.9 kg of German barley and 1.8 kg of Carnaroli rice) and only 0.1 kg of sugar. Within the industrial production, barley is substituted with other cereals (e.g. maize and rice), sugars and additives: using these ingredients, the fraction of malted cereals is reduced together with costs, time and energy required for wort production. Finally, LCA does not allow investigating and highlighting positive aspects of craft beer production and the high quality of its ingredients.

#### **5. References**

- [1] Carlsberg Italia S.p.a with support of IEFÉ - Bocconi University, UN CPC 2431, Beer made from malt, 2013
- [2] European Commission, PEF pilot Beer; Draft Scope and Representative Product - Version 2.0, 2014
- [3] The Climate CO2NSERVANCY, The Carbon Footprint of Fat Tire Amber Ale, 2006
- [4] Blengini, G. A., & Busto, M. , Journal of Environmental Management., From [www.elsevier.com/locate/jenvman](http://www.elsevier.com/locate/jenvman), 2008, November 30
- [5] Assobirra, Annual Report, 2013

# LCA-LCC decision tool for energy generation technologies in a food processing plant

Carlo Strazza<sup>1</sup>, Adriana Del Borghi<sup>1</sup>, Fabio Magrassi<sup>1</sup>, Michela Gallo<sup>1</sup>, Michela Robba<sup>2</sup>

<sup>1</sup>DICCA (Department of Civil, Chemical and Environmental Engineering), University of Genoa,  
Via all'Opera Pia 15 – 16145 Genova (Italy)

<sup>2</sup>DIBRIS (Department of Informatics, Bioengineering, Robotics and Systems Engineering),  
University of Genoa, Via all'Opera Pia 13 – 16145 Genova (Italy)

## 1. Abstract

*Research is needed for the progress of systematic approaches aimed to integrate the potential trade-offs into decision-making processes, including environmental and economic impacts. The set-up of a simple tool dealing with optimization of economic and environmental performance that can be used for setting targets and strategies in energy management is here proposed, with focus on a food processing plant as a case study. Life Cycle Assessment (LCA) and Life Cycle Costing (LCC) methodologies are combined for the formulation of a simplified tool that is able to identify the optimal set of electricity generation technologies from two alternative perspectives, i.e. minimization of Global Warming Potential (GWP) with total cost constraint, and minimization of total cost with GWP constraint.*

## 2. Introduction

Life Cycle thinking (LCt) is a core concept in Sustainable Consumption and Production (SCP) for business strategies in the field of food supply chains [1]. Increasing investigation is registered from production to consumer use until end-of-life phase, to develop and implement strategies that help societies to ensure a sustainable agri-food industry. For instance, in the analysis of crop-derived products, large emphasis is posed on minimization of environmental burdens during cultivation stage [2]; nevertheless, so-called green supply chains should not overlook environmental responsibility of food processing managers. Research is needed for the progress of systematic approaches aimed to integrate the potential trade-offs into decision-making processes, including environmental and economic impacts.

In response to this stimulation for agri-food sector, the set-up of a simple tool dealing with optimization of economic and environmental performance that can be used for setting targets and strategies in energy management of food processing plants is here proposed. The comparable structure of Life Cycle Assessment (LCA) and Life Cycle Costing (LCC) offers the possibility to combine their results in terms of eco-efficiency measures in different ways [3], among which the use of a toolbox has been recently investigated for application to energy generation systems [4].

In this paper LCA and LCC methodologies are integrated into a multicriteria optimization procedure for the formulation of a simplified tool that is able to identify the optimal set of electricity generation technologies from two alternative perspectives, i.e. minimization of Global Warming Potential (GWP) with total cost constraint, and minimization of total cost with GWP constraint. An Italian food processing plant is investigated in order to test the application of the tool for a real case study.

## 3. Methodology

In this work the principles of LCA [5] and LCC [6] are applied for the creation of a procedure to assess the GHG emissions and costs due to the whole life cycle of the selected set of energy generation technologies. Here the proposed optimization tool is tested, as a case study, for the feasible installation within a food

processing plant. The installation, operation and maintenance stage are evaluated for the following alternatives:

- photovoltaic (PV) panels (mono/polycrystalline slanted roof, flat roof, facade)
- small wind turbines (1 kW, 6 kW)
- natural gas micro-turbine (for cogeneration, 65 kWe, 100 kWe, 200 kWe)
- supply from the grid (Italian mix with imports, year 2013).

It must be specified that the decommissioning phase, i.e. the end-of-life of the respective technologies, is excluded from the system boundaries. As regards the impact assessment phase, in terms of GWP, a so-called carbon footprint is accounted in kg CO<sub>2</sub> equivalents (CO<sub>2</sub>eq) by using the characterization factors according to the fifth IPCC report [7], implemented within OpenLCA 1.4 software [8].

Both linear and non-linear optimization procedures are implemented with two alternative objective functions, i.e. minimization of GHG emissions and costs. For this purpose, a multicriteria optimization procedure is operated by means of LINGO 9.0 software [9]. The mathematical formulation of the proposed optimization problem is based on:

- *parameters*: e.g. the module surface of every single PV technology, the nominal power of the technologies, or the GWP value;
- *decision variables*: e.g. the number and kind of technologies to be purchased to produce a certain yearly electrical request;
- *objective functions*: i.e. the minimization of the costs/GHG emissions of the whole system for a fixed time frame;
- *constraints*: e.g. the maximum number of items/modules that can be purchased due to the surface limit of installation, for PV and wind turbines.

A real case study for the application of the developed tool is here selected. For this purpose, a wine production company, in the Italian territory, has been selected, whose information about environmental performance is available from its environmental statement that meets the requirements of the EMAS Regulation. For this plant, the yearly electrical energy request is accounted as 538 MWh. The time horizon is fixed at 20 years.

#### **4. Results and discussion**

The application of the tool shows different solutions when the objective function varies (Table 1). On one side, the minimization of cost entails a total expense (within the time frame) of 786 k€ and a carbon footprint equal to 1,316 t CO<sub>2</sub>eq. On the other side, the minimization of GHG emissions corresponds to an amount of 1,254 t CO<sub>2</sub>eq in 20 years, with a total outflow of 897 k€.

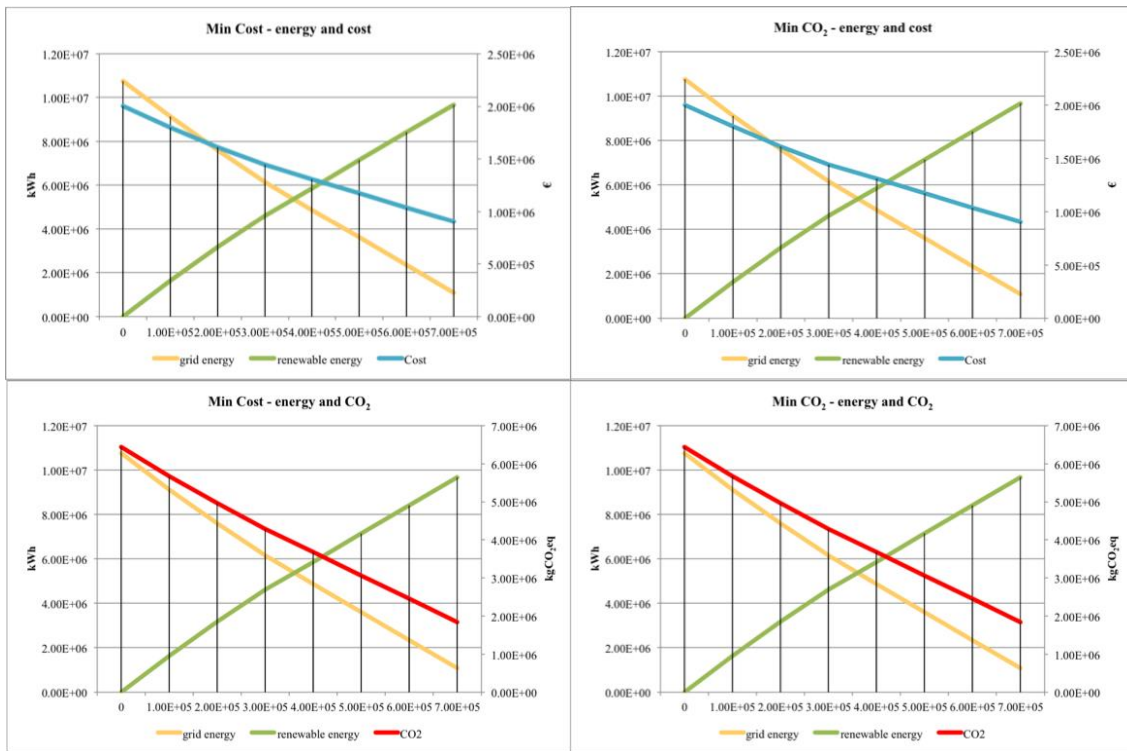

Figure 1 : Analysis of cost/GHG minimization with economical constraint

In order to reach these levels, different technologies are demanded, especially in terms of type of PV panels. Besides, a higher quota of energy from grid is asked to be purchased when the economic driver is set as a priority, with respect to the environmental issue; nevertheless, this amount is slightly significant within the entire time frame. It must be specified that these results are originated by considering an equal exchange between the grid and the owner/user, for auto-production. Moreover, the variation of the optimal solutions is investigated in relation to a constraint in terms of initial expenditure (Figure 1). It can be noted that the behavior of the two different objective functions is coincident until a cap of 600 k€. Successively, some differences arise but they are found to slightly diverge. It can therefore highlighted that, with relatively low initial expenditure, the same solution is identified as optimum both from cost and GHG emissions perspective.

	Grid supply [kWh]	PV flat roof - poly [m <sup>2</sup> ]	PV flat roof - mono [m <sup>2</sup> ]	PV slanted roof – poly [m <sup>2</sup> ]	PV slanted roof - mono [m <sup>2</sup> ]	Wind turbine 6 kW [items]
MIN COST	529	1,620	0	747	2	3
MIN GHG	29	0	2,000	147	77	3

Table 1: Results of cost/GHG minimization

## 5. Conclusions

The methods of multi-criteria analysis are shown to be useful to support the decision maker in the process of organization and synthesis of complex information through a life cycle approach. The developed tool, here tested for the case of a food processing plant, allows to analyze and evaluate different alternatives for satisfaction of electrical energy demand, from both economic and environmental point of view.



## 6. References

- [1] European Commission, ‘Sustainable Consumption and Production and Sustainable Industrial Policy Action Plan’, COM/2008/397 (Bruxelles, 2008).
- [2] Del Borghi, A., Gallo, M., Strazza, C. and Del Borghi, M., ‘An evaluation of environmental sustainability in the food industry through Life Cycle Assessment: the case study of tomato products supply chain’, *J. Clean. Prod.* 78 (2014) 121-130.
- [3] de Haes, H.A.U., Heijungs, R., Suh, S. and Huppes, G., ‘Three strategies to overcome the limitations of life-cycle assessment’, *J. Ind. Ecol.* 8 (3) (2004) 19–32.
- [4] Strazza, C., Del Borghi, A., Costamagna, P., Gallo, M., Brignole, E. and Girdinio, P., ‘Life Cycle Assessment and Life Cycle Costing of a SOFC system for distributed power generation’, *Energy Convers. Manag.* 100 (2015) 64-77.
- [5] International Organization for Standardization (ISO), ‘ISO14040, Environmental management, life cycle assessment’, (Geneva, 2006).
- [6] Barringer, H.P. and Weber, D.P., ‘Life cycle cost tutorial’, in ‘Fifth international conference on process plant reliability’, (Marriott Houston Westside, Houston, Texas, 1996).
- [7] Myhre, G., Shindell, D., Bréon, F. M., Collins, W., Fuglestvedt, J., Huang, J., Koch, D., Lamarque, J. F., Lee, D., Mendoza, B., Nakajima, T., Robock, A., Stephens, G., Takemura, T. and Zhang, H., ‘Anthropogenic and Natural Radiative Forcing’, in: ‘Climate Change 2013: The Physical Science Basis. Contribution of Working Group I to the Fifth Assessment Report of the Intergovernmental Panel on Climate Change’ [Stocker, T.F., Qin, D., Plattner, G. K., Tignor, M., Allen, S.K., Boschung, J., Nauels, A., Xia, Y., Bex, V., Midgley P.M. (eds.)], (Cambridge University Press, Cambridge, United Kingdom and New York, NY, USA, 2013).
- [8] Ciroth, A., ‘ICT for environment in life cycle applications openLCA—A new open source software for life cycle assessment’, *Int. J. Life Cycle Assess.* 12 (4) (2007) 209-210.
- [9] LINDO Systems Inc., ‘LINGO Optimization Modeling Language’, (Chicago, 1993).

# Life Cycle Assessment of Oilseed Canola Production in Iranian Agriculture

Seyed Hashem Mousavi Avval<sup>1,2</sup>, Shahin Rafiee<sup>1</sup>, Mohammad Sharifi<sup>1</sup>, Soleiman Hoseinpour<sup>1</sup>, Bruno Notarnicola<sup>2</sup>,  
Pietro A. Renzulli<sup>2</sup>, Giuseppe Tassielli<sup>2</sup>

<sup>1</sup>Department of Agricultural Machinery Engineering, Faculty of Agricultural Engineering and Technology,  
University of Tehran, Karaj, Iran

<sup>2</sup>Ionian Department of Law, Economics and Environment, University of Bari Aldo Moro,  
Via Lago Maggiore angolo via Ancona, 74121 Taranto, Italy

E-mail contact: [seyed.mousavi@uniba.it](mailto:seyed.mousavi@uniba.it)

## 1. Abstract

The objectives of this study are to assess the environmental impacts of oilseed canola production using cradle-to-farm-gate life cycle assessment (LCA) and to find some solutions to reduce environmental impacts of crop production. Data were taken from 150 canola farms from Mazandaran province, the main center of canola production in Iran. The functional unit was considered as one ton of canola grain. The LCA results indicated that global warming potential was 1181.6 kg CO<sub>2eq</sub> per ton of produced canola. Also, acidification and eutrophication per ton of canola grain were found to be 23.3 kg SO<sub>2</sub> eq and 18.0 kg PO<sub>4</sub><sup>3-</sup> eq, respectively. Emissions due to production and application of chemical fertilizers especially urea had a pivotal effect on environmental burdens. It is concluded that, reducing the consumption of chemical fertilizers, especially N fertilizer, is important for decreasing the environmental footprints in the area.

## 2. Introduction

Environmental management has become increasingly important for productive and innovative businesses and often involves suppliers upstream and the companies downstream. Comprehensive assessment tools are needed that reliably describe environmental impacts of different agricultural systems. LCA is therefore a vital and powerful decision support tool to quantify the integral environmental impacts in the life cycle of a product, and to provide insight into ways to mitigate these impacts and to effectively support sustainable production and consumption [1]. Canola is known as the second dominant oilseed crop in the world. During the 2012/2013 production year, Iran harvested 175,000 tons of canola grain from 93,600 ha of farming land [2]. The objectives of this study are to assess the environmental impacts in oilseed canola production using LCA and to find some solutions to reduce environmental impacts of crop production.

## 3. Methodology

The agro-ecosystem used for this case study is located in Mazandaran province in Iran which is the country's major canola producer [2]. This research focuses on Sari, Neka and Behshahr regions of this province. Canola production in this region mainly relies on natural rainfall with yearly amounts of 1200-1300 millimeters of rain-water. In this region, canola growing occurs mainly in rotation with rice; it is cultivated in winter and harvested in the end of spring. Data were taken from 150 canola production farms using the simple random sampling method and by visiting the farms and interviewing the farmers. Canola farming in the region does not use irrigation, so, environmental impacts from electricity and water for irrigation are not accounted for. The LCA methodology adopted in this study follows the procedure as presented in ISO14040:2006 [3] and ISO 14044:2006 [4] norms.

Soil carbon change for this study was considered outside the system boundary. The functional unit (FU) for this study is one ton of canola grain produced during a single season and the system boundary was cradle-to-farm-gate.

#### 4. Results and discussion

In this study different inputs applied during the production period were investigated; they include agricultural machinery, diesel fuel, lubricants, human labour, chemical fertilizers, manure, chemicals and transportation facilities. The inventory results refer to average data and are presented in Table 1. Also, the direct field emissions of ammonia ( $\text{NH}_3$ ), nitrous oxide ( $\text{N}_2\text{O}$ ),  $\text{NO}_x$  and  $\text{CO}_2$  emitted to air due to fertilizers application, emissions of nitrate ( $\text{NO}_3^-$ ) and phosphorus emitted into water and indirect  $\text{N}_2\text{O}$  from atmospheric deposition of chemical fertilizers and farmyard manure have been calculated using emission models [5] and the results are presented in Table 1.

The results from the characterization of canola production, derived by application of the CML2 baseline methodology, are shown in Table 2. The functional unit is 1 ton canola grain. The global warming potential (GWP) index is a universal and very commonly used index for the comparison of environmental performance of products [6]. Based on the obtained results, GWP was estimated at 1181.6 kg  $\text{CO}_{2\text{eq}}$  per ton of produced canola. On-farm emissions due to application of chemical fertilizers and diesel fuel burning in farm operations of canola production and also emissions from the production of chemical fertilizers especially urea had the largest effect this category. The characterization index of acidification, relative to the functional unit, amounted to 23.3 kg  $\text{SO}_{2\text{eq}}$ . In a previous study which was conducted on wheat production, this index was 4 kg  $\text{SO}_{2\text{eq}}$  [7]; also, the characterization index of the acidification impact category for production of rapeseed and sunflower in Chile was 16 and 23 kg $\text{SO}_{2\text{eq}}$ , respectively [8].

In this study, the characterization index of terrestrial eutrophication impact category for one ton of canola was 18 kg  $\text{PO}_4^{3-}$  eq. The eutrophication index for production of rapeseed and sunflower in Chile was reported as 7.2 and 9 kg $\text{PO}_4\text{eq}$ , respectively [8]. Such high index values for the present study highlight the need to optimise chemical fertiliser application that could lead to a reduction in above-mentioned environmental categories and simultaneously improve the sustainability of canola production in this Iranian province. Marine aquatic ecotoxicity was found to be 420,504.2 kg 1,4-DB eq. In a previous study by Abeliotis et al. [9] LCA of bean production in Greece was investigated; they reported that, marine aquatic ecotoxicity was as 40,000 to 48,400 kg  $\text{t}^{-1}$  for different varieties of bean.

<b>A. Outputs</b>	<b>Unit</b>	<b>Average</b>	<b>SD</b>	<b>CV</b>	<b>Allocation</b>	<b>Price</b>	<b>Income</b>
Canola yield	kg	2076.8	629.7	0.30	99.7	1608.8	1114
Residue	kg	99.2	455.0	4.59	0.3	100	3
<b>B. Inputs from technosphere</b>	<b>Unit</b>	<b>Average</b>	<b>SD</b>	<b>C. On-farm emissions</b>	<b>Unit</b>	<b>Quantity</b>	<b>SD</b>
				<b>9. 1. Emissions to air</b>			
1. Machinery	kg	13.3	3.2		kg		
2. Diesel fuel	kg	91.3	22.2	NH <sub>3</sub> from N		24.2	30.7
3. Lubricant	kg	1.45	0.36	N <sub>2</sub> O from N		3.0	2.6
4. Transportation	tkm	119.3	42.3	CO <sub>2</sub> from urea		154.9	66.7
5. Rape Seed	kg	9.26	2.09	Indirect N <sub>2</sub> O from N fertilizer		0.17	0.07
6. Fertilizers	kg			Indirect N <sub>2</sub> O from manure		0.14	0.38
Urea (46-0-0)		97.1	41.8	CO <sub>2</sub> from labor	kg CO <sub>2eq</sub>	51.0	33.2
Super phosphate triple (0-48-0)		40.5	19.3	N <sub>2</sub> O from residue mix		0.18	0.16
Ammunium phosphate (18-48-0)		2.2	8.8	NO <sub>x</sub> from residue mix		0.74	0.64
potassium sulfate (0-0-52-18)		26.9	20.3	CH <sub>4</sub> from residue burn		1.43	2.26
Ammunium sulphate (35-0-0-35)		9.6	11.9	CO from residue burn		29.95	47.51
NPKS fertilizer (20-20-20-15)		0.5	2.8	N <sub>2</sub> O from residue burn		0.05	0.07
Farmyard manure		992.8	2652.4	NO <sub>x</sub> from residue burn		1.67	2.64
				<b>10.2. Emissions to water</b>			
7. Chemical group (Pesticides) (in terms of active ingredient)	kg				kg		
dinitroanilines (Treflan)		0.26	0.45	NO <sub>3</sub> from N		204.24	178.92
Phenoxy-C. (Gallant super)		0.04	0.07	Phosphorus		1.66	2.01
pyridines (Leontal)		0.83	0.60	<b>3. Emissions to soil</b>		kg	
organo-phosphorous compounds (Diazinon)		0.94	1.18	Trifluralin (Treflan)		0.26	0.45
cyclic-N-compounds (Tilt)		0.11	0.20	Haloxypop-R-methyl (Gallant super)		0.04	0.07
8. Combustion of diesel fuel	MJ	5135.2	1250.2	Clopyralid (Leontal)		0.83	0.60
				Diazinon (diazinon)		0.94	1.18
				Propiconazole (Tilt)		0.11	0.20

Table 1: Life cycle inventory of canola production (referred to 1 ha)

Impact category	Unit	Total
<b>1. Abiotic depletion</b>	kg Sb eq	3.1E-3
<b>2. Abiotic depletion (fossil fuels)</b>	MJ	7023.0
<b>3. Global warming (GWP100a)</b>	kg CO <sub>2</sub> eq	1181.6
<b>4. Ozone layer depletion (ODP)</b>	kg CFC-11 eq	2.7E-5
<b>5. Human toxicity</b>	kg 1,4-DB eq	224.5
<b>6. Fresh water aquatic ecotoxicity</b>	kg 1,4-DB eq	680.5
<b>7. Marine aquatic ecotoxicity</b>	kg 1,4-DB eq	420504.2
<b>8. Terrestrial ecotoxicity</b>	kg 1,4-DB eq	13.6
<b>9. Photochemical oxidation</b>	kg C <sub>2</sub> H <sub>4</sub> eq	0.55
<b>10. Acidification</b>	kg SO <sub>2</sub> eq	23.3
<b>11. Eutrophication</b>	kg PO <sub>4</sub> <sup>3-</sup> eq	18.0

Table 2: Characterization of the canola production referred to the FU (1 t)

## 5. Conclusion

The aim of this study was to carry out a cradle-to-farm-gate LCA of canola production in Iran. LCA has proved to be an effective tool for understanding the eco-profile of Iranian canola farming and should be used for transparent and credible communication between suppliers and their customers. Our research further indicated that global warming potential was estimated at 1,181.6 kg CO<sub>2eq</sub> per ton of produced canola by using average data; data variability from farm to farm is high. Also, acidification and eutrophication were found to be 23.3 kg SO<sub>2</sub> eq and 18.0 kg PO<sub>4</sub><sup>3-</sup> eq per ton of canola grain. On-farm emissions due to application of chemical fertilizers and diesel fuel burning and also emissions from the production of chemical fertilizers especially urea had the most effect on environmental burdens. The usage of atmospheric nitrogen through integrating a legume into the crop rotation can compensate a part of chemical nitrogen required for growing the crops in some intercropping systems. Bean cultivated in summer season is a common option for crop rotation with canola and can help nitrogen fixation. In the Mazandaran province some farmers grow bean with canola in Mazandaran province of Iran. So, reducing the nitrogen input through suitable rotation can be an ecological strategy for lowering environmental burdens if extended to a large number of farmers.

## 6. References

- [1] EC, European Commission- Joint Research Centre- Institute for Environment and Sustainability. International Reference Life Cycle Data System (ILCD) Handbook- General guide for Life Cycle Assessment - Detailed guidance First edition, EUR 24708 EN. Luxembourg, Publications Office of the European Union, (2010).
- [2] Anonymous, Annual agricultural statistics. Ministry of Jihad-e-Agriculture of Iran. [www.maj.ir](http://www.maj.ir). (2015)
- [3] ISO, ISO 14040:2006. Environmental management-Life Cycle Assessment-principles and framework. International Organization for Standardization (2006).
- [4] ISO, ISO 14044:2006. Environmental Management-Life Cycle Assessment-Requirements and Guidelines. European Committee for Standardization. International Organization for Standardization (2006).
- [5] IPCC, Guidelines for national greenhouse gas inventories. In: Eggleston HS, Buendia L, Miwa K, Ngara T, Tanabe K, (Eds.), Prepared by the national greenhouse gas inventories programme. Japan: IGES, (2006).  
<<http://www.ipccngip.iges.or.jp/public/2006gl/index.htm>>.
- [6] Joseph, T., Baah, K., Jahanfar, A. and Dubey, B. A comparative life cycle assessment of conventional hand dryer and roll paper towel as hand drying methods. *The Science of the total environment*. 515-516 (2015) 109-117.
- [7] Wang, M. and Wu, W. Life cycle assessment of the winter wheat-summer maize production system on the North China Plain. *International Journal of Sustainable Development and World Ecology*, 14(4) (2009) 400-407.
- [8] Iriarte, A., J. Rieradevall, and X. Gabarrell, Life cycle assessment of sunflower and rapeseed as energy crops under Chilean conditions. *Journal of Cleaner Production*, 18(4) (2010) 336-345.
- [9] Abeliotis, K., V. Detsis, and C. Pappia, Life cycle assessment of bean production in the Prespa National Park, Greece. *Journal of Cleaner Production*, 41(2013) 89-96.

# Carbon footprint assessment of rapeseed in an intensive, conventional production system in the Wielkopolska region (Poland)

Jerzy Bieńkowski<sup>1</sup>, Janusz Jankowiak<sup>1</sup>, Radosław Dąbrowicz<sup>1</sup>, Małgorzata Holka<sup>1</sup>

<sup>1</sup>Institute for Agricultural and Forest Environment PAS, Bukowska 19, 60-809 Poznań, Poland

E-mail contact: [bjrzy@onet.pl](mailto:bjrzy@onet.pl)

## 1. Abstract

*The aim of the study was to identify the carbon footprint performance of rapeseed production for conventional cultivation practices in the Wielkopolska region (Poland). Analysis is based on the case study of two large-output farms located in the southern part of Wielkopolska. Assessment was undertaken along the life cycle from cradle to farm gate. Overall carbon footprint of rapeseed production was around 794 kg CO<sub>2</sub> eq. t<sup>-1</sup>. Our results show that the fertilizer operation contributed most to the carbon footprinting and that the GHG emissions from the fields were key factors in influencing GHG emissions related to fertilizing activity. It is concluded that the carbon footprint assessment done for the rapeseed production process could be of referential value for the carbon footprint estimations in varying rapeseed cultivation systems and the scale of production in the region.*

## 2. Introduction

Control of GHG emissions should be regarded as an important environmental management in agricultural production in order to mitigate the effects of climate change. In the context of the global increase in demand for food, efforts for emissions reduction should not compromise the need for increasing crop productivity. Although rapeseed has become in recent years a plant of great economic importance in Polish agriculture, there is still a lack of studies regarding its carbon footprint which could take into account regional differences and technological variability of production systems. As literature results show, there is a possibility of reducing the "carbon footprint" of rapeseed-based products through proper use of agricultural practices [1].

The main aim of this study was to determine the size of the carbon footprint of rapeseed grown in the typical cultivation system of large-size farms, considered to be the most representative production type of this crop in Wielkopolska. The secondary objective was to indicate the contribution of different farm-level agricultural operations to the carbon footprint of rapeseed production.

## 3. Materials and methods

The study was conducted during the period 2011-2013. The research places included were two farms, Trzebiny (farm 1) and Długie Stare (farm 2) belonging to the Długie Stare Agricultural Company Ltd., a subsidiary of the State Treasury (see Table 1 for farms descriptions). The company is located in the southern part of the Wielkopolska region. In fact, it is numbered among the small, elite group of farm enterprises of the State Treasury, which are responsible for the creation and the introduction of technological progress in agriculture.

Specification	Farm 1	Farm 2
Usable agricultural area (ha)	492.3	516.2
Soil quality index of arable soils	0.67	1.15
NPK fertilization (kg)	118.1 ±43.6	103.0 ±14.7
Stocking rate (LSU)	0.69 ±0.01	0.72 ±0.03
Cereal yield (t ha <sup>-1</sup> )	5.64 ±0.51	6.58 ±0.23
Rapeseed yield (t ha <sup>-1</sup> )	3.64±0.36	2.62±0.13

Table 1: Farms characteristics (averages from the years 2011-2013 ± standard deviation)

In order to collect data from agronomic activities special farm record sheets were prepared, referring to both to a single plant and a single field. They included field characteristics, type and duration of technological operations, input materials for producing the crop: fertilizers, pesticides, agricultural machinery (type of machine, total machine weight, work time spent for the cultivation of a given crop, lifetime of machine), fuel, engine oil, electricity. Additional sources of data were: the technical documentation of machines, the accounting documents and the interviews with production managers. Data for earlier stages of the processes (industrial inputs for production), preceding the production phase on the farm, were collected from Agribalyse database and literature [2, 3, 4].

The carbon footprint analysis was performed according to the LCA methodology, i.e. from the extraction of raw materials through the main production stage, up to farm-gate. Rapeseed after the harvest has a function of semi-product to be used later in core processes for various purposes in the industry. For such type of product there are no clearly established phases of use and waste disposal, so the analysis is up to the stage of “farm gate”. As there were no co-products in the production system, no allocation procedure was applied for inputs and outputs.

For the evaluation of the carbon footprint, the IPCC model was applied [5]. Direct and indirect emissions of N<sub>2</sub>O associated with the use of mineral fertilizers were calculated based upon EMEP/EEA emission inventory guidebook [6]. On the basis of the list of elements (available from the developed LCI table) results of GHG emissions were assigned to this category. In this paper, calculations of GWP associated with the production of 1 t of rapeseed have been presented. In addition, for the purpose of extending a scope of interpretation of the impact assessment of rapeseed, results analysis have also been referenced to another functional unit of 1 ha of rapeseed cultivation.

#### 4. Results and discussion

The calculated mean value of the carbon footprint of rapeseed in the studied farms, in relation to the functional unit, was 794.2 kg CO<sub>2</sub> eq. t<sup>-1</sup> (Table 2). There were noticeable differences in the GHG emissions between farms. The emissions from farm 1 were lower by 19% compared to the second one. Among the modifying factors of carbon footprint values in a direct way, crop productivity was likely the most important one and yet an intermediate factor, which could be related to soil quality, determining the yield potential of crops with high nutritional requirements.

Technological operations	kg CO <sub>2</sub> eq. t <sup>-1</sup>		kg CO <sub>2</sub> eq. ha <sup>-1</sup>		kg CO <sub>2</sub> eq. t <sup>-1</sup>	kg CO <sub>2</sub> eq. ha <sup>-1</sup>
	Farm 1	Farm 2	Farm 1	Farm 2	Mean	
Cultivation and seeding	58.9	85.5	214.4	223.9	72.2	219.2
Fertilization	567.0	680.1	2063.9	1781.9	623.6	1922.9
Crop protection	37.7	61.9	137.1	162.2	49.8	149.7
Crop harvesting	43.6	53.9	158.6	141.1	48.7	149.9
Total	707.1	881.3	2574.0	2309.1	794.2	2441.6

Table 2: The carbon footprint per functional unit and per unit area of rapeseed cultivation in the analyzed farms (averages for the periods 2011-2013)

The studied farms had a similar set of machinery and they also used similar tillage technology and harvest management. The magnitudes of the carbon footprint in the studied farms are comparable with the Chilean results. In the Araucania region concentrating on rapeseed cultivation in Chile, the carbon footprint associated with this crop was 820 kg CO<sub>2</sub> eq. t<sup>-1</sup> seeds, in the conditions of conventional plough system [7]. The results indicate that the direct and indirect GHG emissions from fields are of main importance in the whole cycle of fertilizer use in rapeseed production (Fig. 1). The average GHG emission from fields was approximately 391 kg of CO<sub>2</sub> eq. t<sup>-1</sup> seeds, which accounted for about 63% of the total GHG emission. In the total emission load from fertilization, 29% of that emission was attributed to a process of fertilizer production. Nearly six times lower GHG emissions occurred in the production of phosphate and potassium fertilizers as compared to nitrogen fertilizers. Emissions associated with fuel consumption and the ones attributed to the use of tractors and machinery in the field work and grain handling were of marginal importance.

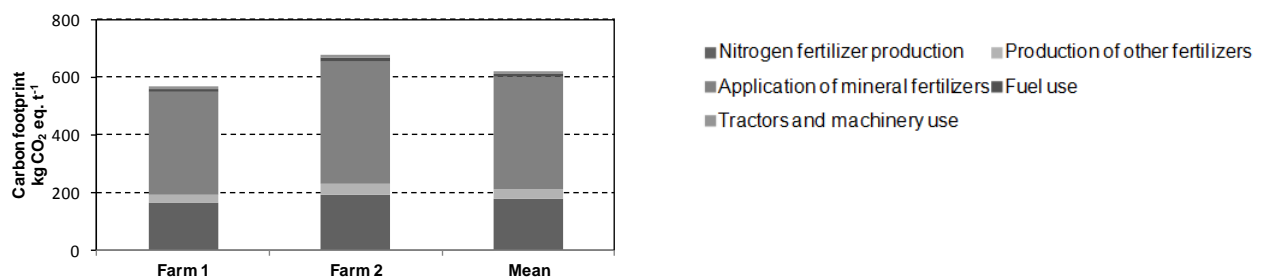

Figure 1: The components of the carbon footprint for rapeseed associated with the process of fertilization in the analyzed farms

## 5. Conclusions

The results of the carbon footprint analysis for the rapeseed production process in the analyzed farms may serve as reference values for the assessment of GHG emission intensity for a similar type of rapeseed cultivation system both in the region, and in the country. Analysis of GHG emissions through carbon footprinting is gaining importance due to the inclusion of agriculture in the EU's emission reduction programs, because such analysis is regarded to be an important tool for the quantitative evaluation of emission changes resulting from the use of different mitigation measures in agricultural production.

Mineral fertilization process contributed highly to the carbon footprint impact. The effect of other agronomical operations on the carbon footprint was many times lower than for fertilization.



At present, there are several possibilities for further reduction of GHG emissions by taking action towards improvements in efficiency of fertilizer use and production, for example by proper timing and application methods, new forms of fertilizers and simplified tillage operations. Information acquired during the field cultivation of rapeseed should be an important part of the inventory database for any industrial processes using this crop as a raw material. Only that degree of data integration will enable a complete assessment of the carbon footprint of rapeseed-based products and its update after the occurrence of significant changes at different stages of the product life cycle.

## 6. References

- [1] Shrestha, B.M., Desjardins, R.L., McConkey, B.G., Worth, D.E., Dyer, J.A., Cerkowniak, D.D., 'Change in carbon footprint of canola production in the Canadian Prairies from 1986 to 2006', *Renewable Energy* 63 (2013) 634-641.
- [2] Colomb, V. Ait-Amar, S., Basset-Mens, C., Dollé, J.B., Gac, A., Gaillard, G., Koch, P., Lellahi, A., Mousset, J., Salou, T., Tailleur, A., van der Werf, H., 'AGRIBALYSE®: Assessment and lessons for the future', Version 1.0. Ed. ADEME, (Angers, France, 2013).
- [3] IPCC, '2006 IPCC Guidelines for national greenhouse gas inventories', Volume 2 Energy, (IGES Hayama, Japan, 2006).
- [4] Audsley, E., Stacey, K., Parsons, D.J., Williams, A.G., 'Estimation of the greenhouse gas emissions from agricultural pesticide manufacture and use', (Cranfield University, UK, 2009).
- [5] IPCC, '2006 IPCC Guidelines for National Greenhouse Gas Inventories', Volume 4 Agriculture, Forestry and Other Land Use, <http://www.ipcc-nggip.iges.or.jp/public/2006gl/vol4.htm> (2006).
- [6] EEA, 'EMEP/EEA Air Pollutant Emission Inventory Guidebook 2013', EEA Technical report No 12/2013, (European Environment Agency, Publications Office of the European Union, Luxembourg, 2013).
- [7] Iriarte, A., Rieradevall, J., Gabarrell, X., 'Life cycle assessment of sunflower and rapeseed as energy crops under Chilean conditions', *Journal of Cleaner Production* 18 (2010) 336-345.

# The ecological footprint of products of oil palm and rubber plantations in Thailand

Charongpun Musikavong<sup>1</sup> and Shabbir H. Gheewala<sup>2,3</sup>

<sup>1</sup>Department of Civil Engineering, Faculty of Engineering, Prince of Songkla University, Songkhla, Thailand

<sup>2</sup>The Joint Graduate School of Energy and Environment, King Mongkut's University of Technology Thonburi, Bangkok, Thailand

<sup>3</sup>Centre for Energy Technology and Environment, Ministry of Education, Bangkok, Thailand

E-mail contact: [mcharongpun@eng.psu.ac.th](mailto:mcharongpun@eng.psu.ac.th) and [charongpun@gmail.com](mailto:charongpun@gmail.com)

## 1. Abstract

*The ecological footprints (EFs) of fresh fruit bunch (FFB) from oil palm and fresh latex, and hevea wood and branches from rubber plantations in Thailand were determined using a life cycle approach for the calculations. The study area covered approximately 72 and 68% of the total area of oil palm and rubber plantations, respectively, in 2013. One hectare each of oil palm and rubber plantations was considered taking into account the use of energy, water, materials, fertilizers, and chemicals for the plantations over one ha-year. The ranges of EF varied from 134 to 569 gha/ha-year and 35.3 to 189 gha/ha-year for oil palm and rubber plantations, respectively. The EF for a ton of FFB was 8.53 gha on average. The average values of EF of a ton of fresh latex, hevea wood, and hevea branches calculated by mass and economic allocations were 2.15 and 17.6, 7.14 and 1.82, and 7.14 and 0.31 gha, respectively. Chemicals and fertilizers were the main sources accounting for more than 85% of the total EF.*

## 2. Introduction

The oil palm and rubber industries are two of the most important economic sectors in Thailand. To support the expansion of these industries, the policy of increasing area under oil palm and rubber cultivation has been promoted resulting in the requirement of more amounts of land to provide resources and to absorb emissions. Thus, the ecological footprint (EF), representing land requirements for providing resources and absorbing emissions in terms of global hectare (gha), can be a useful tool for assessing the impacts of this expansion. The stress on resource use can be evaluated by comparing EF with the carrying capacity of the planet. This work is aimed at determining EFs of the products of oil palm and rubber plantations and evaluating the main contributing sources.

## 3. Materials and methods

A life cycle approach was applied for EF calculations using a cradle to farm gate system boundary. An oil palm plantation consists of seedling and cultivation, fresh fruit bunch (FFB) being the product. A rubber plantation includes seedling, cultivation, and felling of rubber trees. Fresh latex with 30% of dry rubber content (DRC) is the main product. Hevea wood and branches are co-products. The economic life time of both oil palm and rubber plantations is 25 years. The life cycle inventory (LCI) data of oil palm plantations in Chumphon, Krabi, and Suratthani provinces in the south of Thailand and Chonburi in the east were obtained from a Prince of Songkla University (PSU) study.<sup>[1]</sup> The study area accounted for approximately 72% of the total oil palm plantation area in 2013. The LCI data of rubber plantation in 14 provinces were obtained from studies at PSU.<sup>[1,2]</sup> Eight provinces including Chumphon, Narathiwat, Nakhonsithammarat, Pattalung, Pattani, Songkhla, Suratthani, and Yala are located in southeastern Thailand while the remaining six including Krabi, Phangnga, Phuket, Ranong, Satun, and Trang in the southwestern region.

The study area accounted for approximately 68% of the total rubber plantation area in 2013. The EF calculations were conducted using the methodology developed by Rees and Wackernagel.<sup>[3, 4, 5]</sup> The use of energy, water, materials, fertilizers, and chemicals for the plantation of one ha-year was converted to EF of forest land (gha/ha-year). One ha of oil palm and rubber plantations were converted to cropland. The EF was shared between fresh latex, hevea wood and branches by mass and economic values.

#### 4. Results and discussion

The EF of oil palm plantation in Chonburi province was 569 gha/ha-year (Table 1). For southeastern Thailand, the average value of EF was determined as 180 gha/ha-year. The EF of oil palm plantation in Krabi in the southwestern Thailand was 154 gha/ha-year. The average value of EF for oil palm plantation was 185 gha/ha-year. Cultivators in Chonburi used higher amount of herbicides than other provinces leading to a very high EF. Thus, the highest value of EF for the oil palm plantation was found in the east of Thailand followed by that of in southeastern and southwestern Thailand, respectively. For producing FFB of 20.9 ton/ha-year, average values of applied nitrogen (N), phosphorus (P), and potassium (K) fertilizers were 168, 110, and 521 kg, respectively. The chemical use of 50.1 kg was determined, on average.<sup>[1]</sup> The fertilizers were the major source of EF in the south of Thailand and chemicals for the east of Thailand. The fertilizers and chemicals were the main EF sources accounting for 47.9 and 45.8% of average EF, respectively. The range of EF for the rubber plantations in southeastern Thailand was from 35.3 to 126 gha/ha-year whereas that of in the southwestern Thailand was from 99.4 to 189 gha/ha-year. The large range was mainly due to the differences in fertilizer use. The EF of rubber plantation in the southwestern Thailand was on average about 50% higher than that of the southeastern Thailand. This is because the rubber plantations in southwestern Thailand applied a large amount of fertilizers in comparison with that of the southeast. The average value EF for the rubber plantation was 95.9 gha/ha-year. For producing fresh latex (dry rubber) at 1.7 ton/ha-year, N, P, and K fertilizers were applied at 117, 57.1, and 92.6 kg, respectively.<sup>[1, 2]</sup> After 25 years, hevea wood and branches of 228 and 75 tons/ha were obtained, respectively. The fertilizer (74.3% of total EF) was the main EF source followed by green water (14.5%) and chemicals (9.61%), respectively. Table 2 shows the EF values of the products of oil palm and rubber. The average value of EF for a ton of FFB was 8.53 gha whereas for a ton of fresh latex (DRC 30%), hevea wood, and hevea brances calculated by mass and economic allocations were 2.15 and 17.6, 7.14 and 1.82, and 7.14 and 0.31gha, respectively.

Provinces	Ecological footprint (gha/ha-year)							
	Energy	Forest					Cropland	Total
	Fuel	Water		Material	Fertilizer	Chemical		
		Green	Blue					
The oil palm plantation								
East (Chonburi)	0.65	10.6	7.56	0.03	79.9	470	0.40	569
Southeast								
Chumphon	0.11	13.2	2.44	0.08	215	8.23	0.40	240
Suratthani	0.06	13.6	2.60	0.11	93.7	24.3	0.40	134
*Average	0.08	13.4	2.53	0.10	146	17.3	0.40	180
Southwest (Krabi)	0.29	15.6	1.14	0.02	136	0.01	0.40	154
*Total average	0.17 (0.09%)	14.1 (7.60%)	2.24 (1.21%)	0.07 (0.04%)	142 (76.3%)	27.0 (14.6%)	0.40 (0.22%)	185
The rubber plantation								
Southeast	0.02-0.04	11.8-15.1	0.001-2.22	0.10	18.0-89.3	0.002-21.4	0.40	35.3-126
* Average	0.03	13.6	1.13	0.10	60.0	8.81	0.40	84.1
Southwest	0.03-0.04	12.6-16.9	<0.001-0.88	0.10	73.3-173	3.39-12.8	0.40	99.4-189
*Average	0.03	14.7	0.51	0.10	100.3	10.3	0.40	126
*Total average	0.03 (0.03%)	13.9 (14.5%)	0.95 (0.99%)	0.10 (0.10%)	71.3 (74.3%)	9.22 (9.61%)	0.40 (0.42%)	95.9

Remark: EF of electricity was less than 0.01% of total EF. \*Weighted average

Table 1: EF of oil palm and rubber plantations (gha/ha-year)

Provinces	Ecological footprint (gha/ton product)					
	FFB	Mass allocation		Price allocation		
		Fresh latex (DRC 30%)	Hevea wood and branches	Fresh latex (DRC 30%)	Hevea wood	branches
Chonburi (east)	31.1	-	-	-	-	-
Chumphon (southeast)	11.7	0.78	2.60	6.56	0.70	0.12
Suratthani (southeast)	6.10	1.82	6.05	14.4	1.50	0.26
Krabi (southwest)	6.80	3.35	11.2	27.3	2.81	0.48
Southeast (*average value)	8.47	0.78-2.78 (1.92)	2.60-9.27 (6.34)	6.56-22.2 (15.6)	0.70-2.29 (1.61)	0.12-0.40 (0.28)
Southwest (*average value)	N.A.	2.22- 4.21 (2.84)	7.38-14.0 (9.43)	18.8-35.1 23.6	1.95-3.61 2.42	0.34-0.62 0.42
*Total Average	8.53	2.15	7.14	17.6	1.82	0.31

Remark:\*Weighted average

Table 2: EF of products of oil palm and rubber plantations (gha/ton products)

#### **4. Conclusion**

A large amount of chemicals and fertilizers are used for oil palm plantations as compared to rubber plantations in Thailand. Oil palm plantations require moderately higher land for providing resources and absorbing emissions than that of the rubber plantations. This study reveals the need for implementing good management practices for reducing the over use of chemicals and fertilizers which could help reduce cost and impacts on carrying capacity.

#### **5. Acknowledgement**

This research was supported by the national Science and Technology Development agency under the project “Research Network for LCA and Policy on Food, Fuel, and Climate Change”.

#### **6. References**

- [1] PSU. ‘Water footprint evaluation of palm oil, biodiesel and para rubber products’. Final Report, National Science and Technology Development Agency, Bangkok, 2013.
- [2] PSU. ‘Evaluation of water footprint of the new area rubber plantation in southern Thailand.Final Report, Thailand Research Fund, Bangkok, 2015.
- [3] Rees, W.E., ‘Revising carrying capacity: area-based indicators of sustainability’, *Population and Environmental*. 17(3) (1996) 195-215.
- [4] Wackernagel, M., Rees, W., ‘Our ecological footprint-reducing human impact on the Earth’. *Environment and Urbanization* 8 (2) (1996) 216-216.
- [5] Wackernagel, M., Rees, W., ‘Perceptual and structural barriers to investing in natural capital: economics from an ecological footprint perspective’ *Ecological economics*. 20 (1) (1997) 3-24.

# Comparative LCA of sunflower, rapeseed and soybean oils

Érica Castanheira<sup>1</sup>, Filipa Figueiredo<sup>1</sup>, João Malça<sup>1,2</sup>, Fausto Freire<sup>1</sup>

<sup>1</sup>ADAI-LAETA, Center for Industrial Ecology, Department of Mechanical Engineering,  
University of Coimbra, Rua Luis Reis Santos, 3030-788 Coimbra, Portugal

<sup>2</sup>Department of Mechanical Engineering, ISEC, Polytechnic Institute of Coimbra, Rua Pedro Nunes,  
3030-199 Coimbra, Portugal

[erica@dem.uc.pt](mailto:erica@dem.uc.pt); [filipa.figueiredo@dem.uc.pt](mailto:filipa.figueiredo@dem.uc.pt); [jmalca@dem.uc.pt](mailto:jmalca@dem.uc.pt); [fausto.freire@dem.uc.pt](mailto:fausto.freire@dem.uc.pt)

## 1. Abstract

*The aim of this article is to assess and compare the life-cycle (LC) environmental impacts of three vegetable oils (sunflower, rapeseed and soybean) addressing alternative cultivation locations and land-use change (LUC) scenarios. LUC can contribute significantly to climate change (about 15-83% for sunflower, 38-85% for soybean and 5-66% for rapeseed oil). Cultivation is the life-cycle stage with the highest impacts for the remaining categories, except for soybean oil terrestrial acidification and photochemical oxidant formation mainly due to transportation emissions. The allocation method adopted significantly affected the results. The environmental impacts can be reduced by avoiding LUC, increasing crop yields and optimizing transportation.*

## 2. Introduction

Sunflower, rapeseed and soybean oils represented more than 80% of the vegetable oils produced in Europe in 2011 (24.5 million tonnes) [1]. These oils are used for food and bioenergy purposes, being produced from both endogenous and imported feedstock (oilseeds). Few studies performed a comparative assessment of the environmental impacts of vegetable oils (e.g. [2, 3]). Although a large number of life-cycle studies exist for vegetable oils and biodiesel, they have mainly focused on climate change. The aim of this article is to assess and compare the life-cycle environmental impacts of three vegetable oils (sunflower, rapeseed and soybean) produced in Southern Europe, addressing alternative cultivation locations and land-use change (LUC) scenarios. A sensitivity analysis was also conducted using alternative allocation approaches for the treatment of co-products (energy, mass and market prices).

## 3. Life-cycle model and inventory

Figure 1 presents the production chain of sunflower, rapeseed and soybean oils, showing locations, yields and LUC scenarios assessed. A “cradle-to-gate” approach was followed, which includes LUC, crop cultivation, transport, oil extraction and neutralization. Different scenarios for cropland area expansion were assessed (including no LUC): for sunflower and rapeseed, improved and severely degraded grassland conversion (LUC1 and LUC2); for soybean, perennial cropland and severely degraded grassland (LUC1 and LUC2).

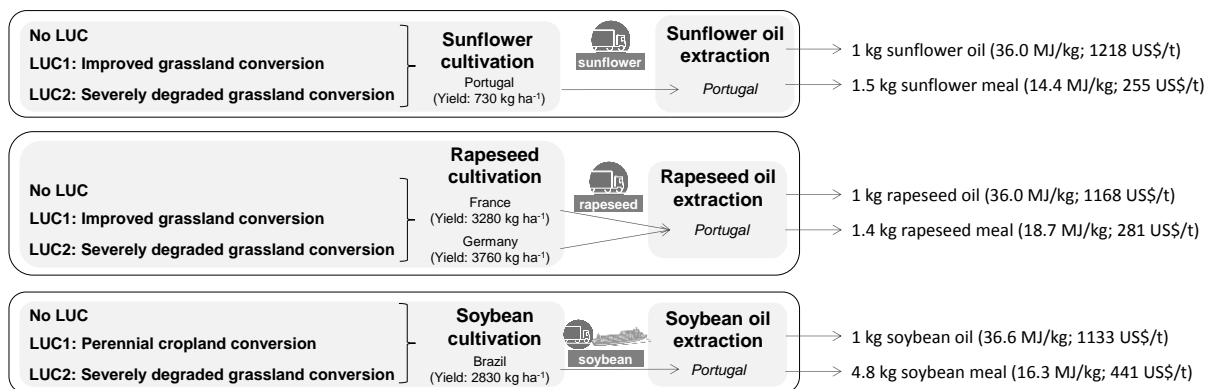

Figure 1: Life-cycle chain (cradle-to-gate) of sunflower, rapeseed and soybean oil.

The inventory was implemented based on cultivation data and typical agricultural practices for potential producing regions for each crop: rainfed sunflower cultivation in Portugal [4]; full-tillage with medium inputs to soil for rapeseed grown in France and Germany [5]; and reduced-tillage with medium inputs for soybean cultivated in the south of Brazil [6]. Extraction and neutralization data for the three oils was gathered from industrial units in Portugal [7]. It is assumed that sunflower seed was transported by road on average 200 km in Portugal [4], whereas rapeseed came from France (1620 km) and Germany (2860 km) by truck [5]. Soybean grain was transported by road from farms to the port in Brazil (1456 km) and by ship to Portugal (8371 km) [6].

#### 4. LC environmental impacts

The following environmental impacts (ReCiPe method [8]) were assessed: climate change (CC); terrestrial acidification (TA); freshwater and marine eutrophication (FE & ME) and photochemical oxidant formation (POF). Figure 2 presents the impacts per L of oil calculated with energy allocation. Climate change results include the various LUC scenarios. Results for mass and economic (price-based) allocation are presented in the chart as range (error) bars. The lowest impacts were calculated for mass allocation and the highest for economic allocation.

The lowest environmental impacts were calculated for sunflower oil, except for ME and CC-no LUC (similar to soybean oil) and for scenario LUC1, for which rapeseed oil presented the lowest CC impact. LUC can have a significant impact, namely scenario LUC1, which increases the CC impact of sunflower and soybean by about 6-7 times and for rapeseed by about 2-3 times. The climate change is the lowest for oil crops cultivated with no LUC or with low carbon emissions due to LUC (e.g. LUC2: severely degraded grassland). Cultivation is the life-cycle stage with the highest impacts for the remaining categories, except for soybean oil TA and POF impacts mainly due to transportation emissions ( $\text{NO}_x$ ).

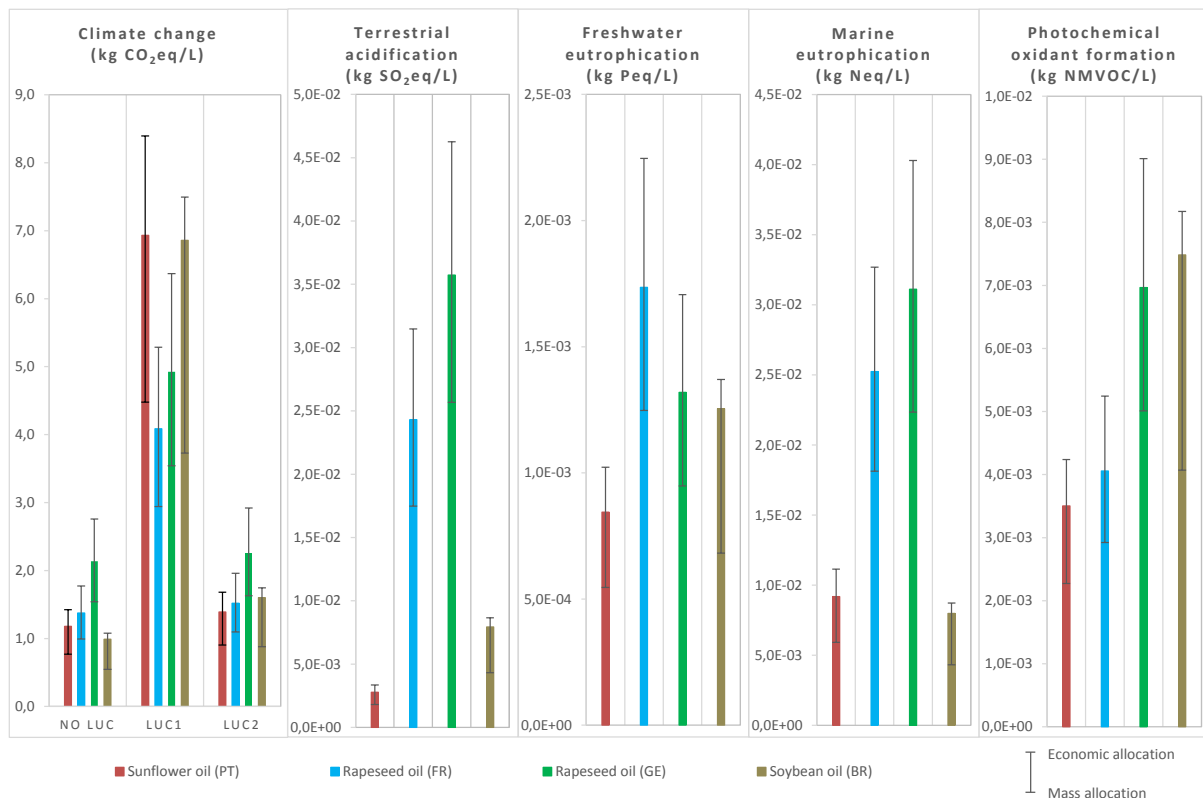

Figure 2: Environmental impacts per liter of sunflower, rapeseed and soybean oils: sensitivity analysis to allocation

## 5. Conclusions

A comparative life-cycle assessment of three vegetable oils (sunflower, rapeseed and soybean) was conducted. The LC environmental impacts of the three oils depended significantly on the crop cultivation location, due to the differences in crop productivity and LUC in each country, as well as transportation distances between farms and oil extraction plants. The results showed a significant influence of the allocation method adopted (lowest impacts for mass, highest for price). The environmental impacts of vegetable oils can be reduced by avoiding LUC (or planting crops on severely degraded grassland), increasing yields and optimizing transportation.

## 6. Acknowledgments

This work was funded by FEDER funds through “Programa Operacional Factores de Competitividade” - COMPETE and by the Portuguese Science and Technology Foundation (FCT) projects FCOMP-01-0124-FEDER-029055 (PTDC/EMS-ENE/1839/2012) and FCOMP-01-0124-FEDER-021495 (PTDC/SEN-TRA/117251/2010), and is framed under the Energy for Sustainability Initiative of the University of Coimbra, Portugal, supported by the R&D project EMSURE (CENTRO-07-0224-FEDER-002004). 6.



## 7. References

- [1] FAO, 2015. FAOSTAT. FAO - Food and Agriculture Organisation of the United Nations, Statistics Division. Available at: <http://faostat.fao.org>
- [2] Arvidsson, R., Persson, S., Fröling, M., Svanström, M. 'Life cycle assessment of hydrotreated vegetable oil from rape, oil palm and Jatropa', *Journal of Cleaner Production* 19 (2013) 129–137.
- [3] Schmidt, J.H. 'Life cycle assessment of five vegetable oils' *Journal of Cleaner Production* 87 (2015) 130-138.
- [4] Figueiredo, F., Castanheira, É.G., Freire, F. 'LCA of sunflower oil addressing alternative land use change scenarios and practices', *Proceedings of the 8th International Conference on Life Cycle Assessment in the Agri-Food Sector (LCA food 2012)*, Saint-Malo, France, 1-4 October, 2012, 257-261.
- [5] Malça, J., Coelho, A., Freire, F. 'Environmental Life-Cycle Assessment of rapeseed-based biodiesel: alternative cultivation systems and locations', *Applied Energy* 114 (2014) 837-844.
- [6] Castanheira, É.G., Freire, F. 'Greenhouse gas assessment of soybean: implications of land use change and different cultivation systems', *Journal of Cleaner Production* 54 (2013) 49-60.
- [7] Malça, J., Castanheira, É., Figueiredo, F., Freire, F. 'Comparative GHG assessment of biodiesel produced from rapeseed, soybean and sunflower', *Energy for Sustainability 2013, Sustainable Cities: Designing for People and the Planet*, Coimbra, Portugal, 8-10 September, 2013.
- [8] Goedkoop, M., Heijungs, R., Huijbregts, M., De Schryver, A.M., Struijs, J., van Zelm, R., 2012. ReCiPe 2008: a life cycle impact assessment method which comprises harmonised category indicators at the midpoint and the endpoint level; First edition (revised); Report I: Characterisation, July 2012. Available at: <http://www.lcia-recipe.net> (accessed January 2013).

# Life Cycle Assessment of organic apple supply chain in the North of Italy

Authors: Sonia Longo<sup>1</sup>, Marina Mistretta<sup>2</sup>, Maurizio Cellura<sup>1</sup>, Markus Kelderer<sup>3</sup>, Flavio Paoletti<sup>4</sup>

<sup>1</sup>Dipartimento di Energia, Ingegneria dell'Informazione e Modelli Matematici (DEIM) –  
Università degli Studi di Palermo, Viale delle Scienze Ed.9, 90128 Palermo (Italy)

<sup>2</sup>Dipartimento Patrimonio Architettonico e Urbanistico (PAU) –  
Università degli Studi Mediterranea di Reggio Calabria, Salita Melissari, 89124 Reggio Calabria (Italy)

<sup>3</sup>Centro di Sperimentazione Agraria e Forestale Laimburg, Ora (Bz) (Italy)

<sup>4</sup> Centro di Ricerca per gli Alimenti e la Nutrizione (NUT), Via Ardeatina 546, 00100 Roma (Italy)

E-mail contact: [mcellura@dream.unipa.it](mailto:mcellura@dream.unipa.it)

## 1. Abstract

*The goal of the study is the assessment of the energy and environmental impacts of 1 ton of organic apples cultivated in the North of Italy, by applying the Life Cycle Assessment methodology. The authors examined the supply chain of apples, by including the supply of raw materials and energy sources, and the farming step. In addition, an assessment of apple distribution to the final users was made.*

*The results show that a relevant share of the total impacts is caused by the transport to the final users, assuming that the product is distributed on local, national and international markets. A detailed analysis of the farming step shows that a significant share in the overall energy and environmental impacts is due to the use of insecticides and to the consumption of diesel for agricultural machines.*

## 2. Introduction

Agriculture is one of the main sectors affecting the environment through its direct impacts on land use and ecosystems, and on global and regional cycles of carbon, nutrients and water. At global level, agriculture contributes to climate change through emission of greenhouse gases and reduction of carbon storage in vegetation and soil. Locally, agriculture reduces biodiversity and affects natural habitats through land conversion, eutrophication, chemical product inputs, irrigation, etc [1].

The environmental pressure from agriculture can be reduced with organic farming, which represents a key factor in the agricultural sector, due to the added value of its products, to the socio-economic benefits for the producers and to the positive effects on the environment and on the human health.

To calculate the burdens of the whole supply chain of organic products and to compare them with the impacts of conventional products becomes significant for assessing the effective energy and environmental advantages due to the cultivation of these products instead of non-organic ones.

## 3. Case study: LCA of organic apples in the North of Italy

The present study was developed within the project “BIOQUALIA – Nutritional and organoleptic quality and environmental impact of organic productions”, funded by the Italian Ministry of Agriculture, Food and Forestry Policies.

### 3.1 Goal and scope definition

The goal of the study is the assessment of the energy use and environmental impacts of 1 ton of organic apples (selected as functional unit) cultivated in the North of Italy. The study was carried out applying the

Life Cycle Assessment (LCA) methodology as regulated by the international standards of series ISO 14040 [2, 3].

The authors examined the supply chain of apples, which includes the supply of raw materials and energy sources, and the cultivation step. Particular attention was paid on key issues, such as energy consumption, water use and insecticide use in the farming activities. In detail, the following steps of the cultivation process of apples were examined: machine use, pruning, land management, fertilization, irrigation, thinning, antiparasitic treatment, replanting, harvest and transfer to cooperatives, and post-harvest defense. Further details on each step of the cultivation process can be found in [4]. In addition, an assessment of raw material transport and distribution of apples to the final users was made, assuming that the product is distributed on local (10%), national (40%) and international markets (50%).

### *3.2 Life Cycle Inventory and Life Cycle Impact Assessment*

The inventory analysis was carried out to quantify the environmentally significant inputs and outputs of the examined system, by means of a mass and energy balance of the selected functional unit.

The main energy and material inputs and outputs of the apple supply chain were collected from local investigations. Eco-profiles of energy sources, materials and transports were from international environmental databases [5, 6].

The inventory data, in terms of resource consumption, air, water and soil emissions, and waste production, were elaborated and synthesized by using the following impact categories: global energy requirement (GER), global warming potential (GWP), ozone depletion potential (ODP), acidification potential (AP), eutrophication potential (EP), photochemical ozone creation potential (POCP).

The characterization factors for GER were from the Cumulative Energy Demand [6] method, that enables the estimation of the consumption of renewable (biomass, wind, solar, geothermal, water) and non-renewable (fossil, nuclear) energy sources. The other environmental characterization factors were from the EPD 2013 impact assessment method [7].

The obtained results are detailed in the following. GER was 6.9 GJ/ton, of which 98.5% is represented by non-renewable energy sources. The transport of apples to the final users is responsible of about 70.9% of the total energy impact, and the remaining 29.1% is due to the cultivation (28.9%) and the transport of raw materials (0.2%).

A detailed analysis of the cultivation step (Fig. 1) showed that the main impacts are caused during replanting (23.7%), harvest and transfer to cooperatives (20.2%), irrigation (19.4%), and antiparasitic treatment (18.2%). The other steps give a contribution variable from 1.1% to 6.7%.

The environmental impacts, referred to the functional unit, are the following: GWP 425.45 kg CO<sub>2eq</sub>, ODP 7.38E-05 kg CFC-11<sub>eq</sub>, AP 2.30 kg SO<sub>2eq</sub>, EP 0.76 kg PO<sub>4</sub><sup>3-</sup><sub>eq</sub>, POCP 0.57 kg C<sub>2</sub>H<sub>4eq</sub>.

The percentage incidence of each examined step on the total impact, mainly caused by the transport of apples to the final users, is showed in Table 1.

Referring to the cultivation, GWP, POCP and AP are mainly caused by replanting step, which contributes to the above impacts for about 24.1%, 22.5% and 21.0%, respectively. The machine management is the main

responsible of the impact on ODP (52.6% of the total), while the fertilization step causes about 43.6% of the impact on AP.

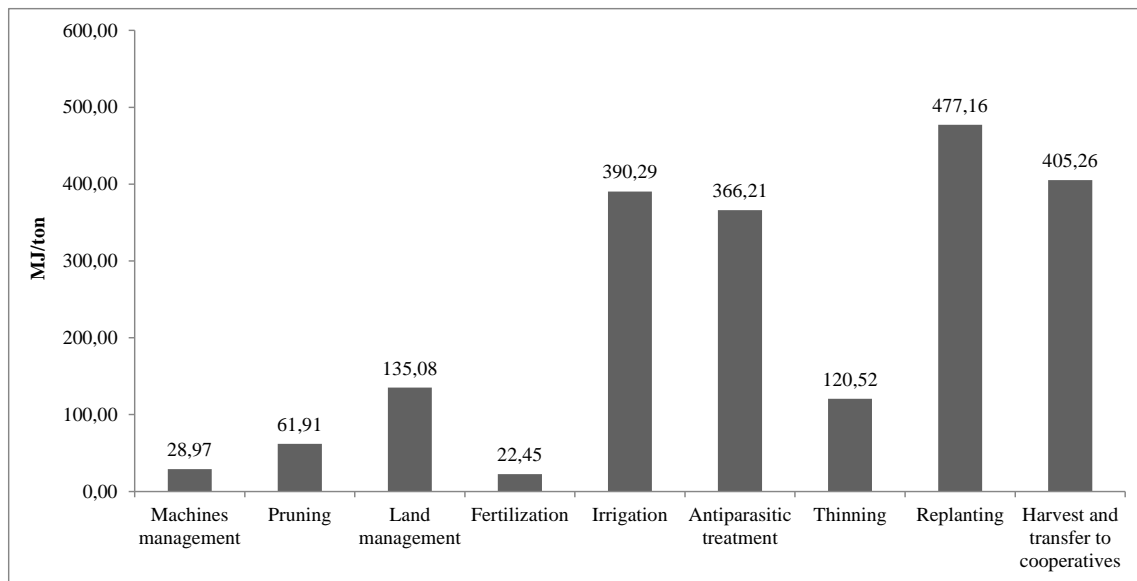

Figure 1: GER of the cultivation step

	Cultivation	Transport of raw materials	Transport of apples to final users	Total
GWP (kg CO <sub>2eq</sub> )	133,42	0,81	291,22	425,45
ODP (kg CFC-11 <sub>eq</sub> )	3,20E-05	1,03E-07	4,17E-05	7,38E-05
POCP (kg C <sub>2</sub> H <sub>4eq</sub> )	0,18	0,001	0,39	0,57
AP (kg SO <sub>2eq</sub> )	0,87	0,003	1,43	2,30
EP (kg PO <sub>4</sub> <sup>3-</sup> <sub>eq</sub> )	0,38	0,00	0,38	0,76

Table 1: Environmental impacts: incidence of each examined step

A preliminary comparison between the obtained results and the impacts of conventional apples [8, 9, 10] was carried out, even if a reliable comparison should be made by using data coming from the same geographic area, considering that different climate and cultivation techniques can significantly influence the final results. The comparison showed that, generally, there are not significant differences between organic and conventional apples in terms of energy and environmental impacts. However, as demonstrated by the project BIOQUALIA of which this research is part, organic apples have superior nutritional and organoleptic characteristics than conventional ones.

#### 4. Conclusion

The LCA methodology can support the development of studies that aim at reducing energy and environmental impacts throughout the supply chain of products and can contribute to the application of sustainable production and consumption strategies [11, 12].

The study focused on the analysis of impacts of organic apples. The application of LCA allowed assessing the incidence of each life cycle step of apples supply chain on the overall impacts and selecting the “hot spots” of the examined system, by the identification of steps and processes responsible of the largest impacts. The results showed that a relevant share of the total impacts (variable from about 51% to about 71%) was caused by the transport of apples to the final users, and in particular to the distribution to international markets. A detailed analysis of the farming step was carried out, showing that a significant share in the overall energy and environmental impacts is due to the use of insecticides and to the consumption of diesel for agricultural machines.

## 5. References

- [1] European Environment Agency, 'Agriculture and the green economy', (EEA, 2012).
- [2] ISO 14040, 2006, 'Environmental management - Life cycle assessment - Principles and framework', 2006, International Organization for Standardization.
- [3] ISO 14044, 2006, 'Environmental Management e Life Cycle Assessment e Requirements and Guidelines', 2006, International Organization for Standardization.
- [4] Standardi, A., Famiani, F., Proietti, P., 'Manuale di corretta prassi per la produzione integrata del melo', 2000 (Ed. 3A Parco tecnologico Agroalimentare dell'Umbria, 2000).
- [5] Ecoinvent Centre, 'Ecoinvent database', 2011, Swiss Centre for Life Cycle inventories.
- [6] PRè-Product Ecology Consultants, 2011, 'SimaPro environmental database'.
- [7] The International EPD Cooperation, 2013, 'General Programme Instructions for Environmental Product Declarations'.
- [8] Milà i Canals, L., Burnip, G.M., Cowell, S.J., 'Evaluation of the environmental impacts of apple production using Life Cycle Assessment (LCA): Case study in New Zealand', *Agriculture, Ecosystems and Environment* 114 (2006) 226–238.
- [9] Sessa, F., Marino, M., Montanaro, G., Dal Piaz, A., Zanotelli, D., Mazzetto, F., Tagliavini, M. 'Life Cycle Assessment of apples at a country level: the case study of Italy', in Schenck, R., Huizenga, D. (Eds.), 2014. Proceedings of the 9th International Conference on Life Cycle Assessment in the Agri-Food Sector (LCA Food 2014), 8-10 October 2014, San Francisco, USA. ACLCA, Vashon, WA, USA.
- [10] Cerutti, A.K., Beccaro, G.L., Mellano, G.M., Canterino, S., Donno, D., Bounous G., 'Applicazione della metodologia LCA ai sistemi di produzione frutticola: aspetti chiave e studi di caso', 09 novembre 2011, ECOMONDO, Rimini Fiera Atti del Convegno della Rete Italiana LCA.
- [11] Ardente, F., Cellura, M., Longo, S., 'From LCA of food products to the environmental assessment of protected crops districts: a case study in the South of Italy', *Journal of Environmental Management* 93 (2012) 194-208.
- [12] Cellura, M., Longo, S., Mistretta, M., 'Life Cycle Assessment (LCA) of protected crops: an Italian case study', *Journal of Cleaner Production* 28 (2012) 56-62.

# Environmental assessment of rice cultivation: a case study of fertilisation with urban sewage

Alessandra Fusi<sup>1</sup>, Jacopo Bacenetti<sup>1</sup>, Sara González-García<sup>2</sup>, Gumersindo Feijoo<sup>2</sup>,  
María Teresa Moreira<sup>2</sup> and Marco Fiala<sup>1</sup>

<sup>1</sup>Department of Agricultural and Environmental Sciences, Production, Landscape, Agroenergy,  
Università degli Studi di Milano, Via G. Celoria 2, 20133 Milan, Italy.

<sup>2</sup>Department of Chemical Engineering, School of Engineering, University of Santiago de Compostela,  
15782- Santiago de Compostela, Spain

E-mail contact: [alessandra.fusi@manchester.ac.uk](mailto:alessandra.fusi@manchester.ac.uk)

## 1. Abstract

*In this study, the environmental profile of rice cultivation in a farm located in Pavia district (Lombardy) fertilised with urban sewage was evaluated using the Life Cycle Assessment methodology from a cradle-to-field gate perspective. Inventory data were collected in a rice farm (102 ha) over a 3-years period. A number of environmental hotspots were identified: a) methane emissions contributing to climate change, b) emissions associated to fertiliser application contributing to acidification and particulate matter formation c) diesel requirements in field operations accounting for mineral fossil resource depletion and d) grain drying contributing to ozone depletion. A sensitivity analysis regarding both rice yields and methane emission factors was performed in order to predict their influence on the overall environmental profile.*

## 2. Introduction

According to the Rice Outlook 2014, there are around 159.6 million hectares of rice all over the world with an annual global production of 474.6 million tons. In Europe, Italy is the most important country in terms of rice production [2], especially the North Italian districts that present the most advanced rice cultivation sites accounting for  $\approx 55\%$  of European rice area [2]. In 2014, 219,532 ha were dedicated to rice cultivation in Italy with 4,093 farms mainly located in the districts of Pavia, Vercelli and Novara [2]. Rice cultivation involves different agricultural activities that produce different impacts on the environment. Such impacts are mainly associated to the use of fossil fuels and agrochemicals and to methane emissions arising from the fermentation of organic material in the flooded rice fields [3-4].

In terms of rice cultivation practice, different solutions could be performed regarding the environmental key factors (flooding, fertilisation and straw management). Since rice cultivation takes place mainly in area with low livestock activities, fertilisation is usually performed using mineral fertilisers although (when available) organic fertilisers such as animal slurry or urban sewage could be used. Regarding the use of organic fertilisers (manure, digestate, urban sewage, etc..) involves higher methane emission rates than mineral fertilisers due to the highest decomposition rates of the organic matter in anoxic environment [4].

In this study, the environmental performance of rice cultivation in Pavia district (Lombardy) fertilised with urban sewage was evaluated from a cradle-to-field gate perspective. Besides the environmental evaluation and the environmental hotspots identification, this study aimed to highlight the environmental impact coming from the application of urban sewage.

### 3. Goal and scope definition, functional unit and system boundaries

The goal of this study is the evaluation of the environmental performance of rice cultivation fertilised with urban sewage. The most critical agricultural processes for the rice cultivation system were identified. 1 ton of paddy rice (14% of moisture content) was selected as functional unit. A cradle-to-farm gate perspective was adopted. The rice cultivation flow-chart is shown in Figure 1.

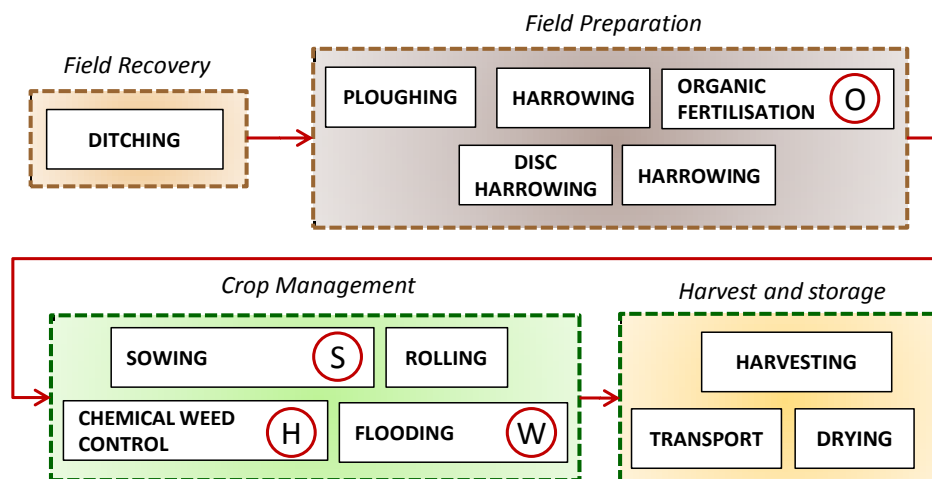

Figure 1 :Flow-chart of rice cultivation (O = Urban sewage ; S = seed; H = herbicide ; W = water)

The following activities were included in the analysis: raw materials extraction (e.g., fossil fuels and minerals), manufacture of the agricultural inputs (e.g., seeds, fertilisers, herbicides and agricultural machines), use of the raw materials and of the other inputs (fertilisers emissions, diesel fuel emissionstire abrasion emissions), maintenance and final disposal of machines

### 4. LCI and LCIA

Data concerning field operations and drying were obtained via questionnaires and surveys to the farmers. More specifically, information regarding fertilisers and herbicides was collected by consulting the “Quaderni di campagna”, a mandatory document in which their use is reported. Average yields of rice grain and straw were 8.02 t/ha (27% moisture content - corresponding to 6.81 t/ha at the commercial moisture) and 6.6 t/ha (dry matter), respectively.

Nitrate, ammonia, and nitrous oxide emissions were computed following the methodology described by Brentrup et al. [5]. Default methane emission rate proposed by the IPCC [6] (1.3 kg of CH<sub>4</sub>/ha·day) for anaerobic decomposition was considered.

The characterisation factors reported by the ILCD method were used [7] and the following impact categories were considered for the assessment: climate change (CC), ozone depletion (OD), particulate matter (PM), photochemical oxidant formation (POF), terrestrial acidification (TA), freshwater eutrophication (FE), terrestrial eutrophication (TE), marine eutrophication (ME), and mineral fossil and renewable resource depletion (MFRD). Due to the uncertainties about the definition of characterization factors for many active ingredients, the toxicity-related impact categories were excluded [8]. Nevertheless, considering that the extensive application of plant protection products (mainly herbicide and pesticides) in combination with wrong agricultural practices could result in environmental issues such as contamination of natural resources and risks for human health [9], a further development of the study should assess also these aspects.

## 5. Results

The environmental *hotspots* of rice cultivation using sewage sludge as organic fertiliser are shown in Figure 2. Field emissions, mainly related to fertiliser application (ammonia volatilization, dinitrogen monoxide and nitrate leaching) and organic matter decomposition (methane), account for 70 up to 98% of CC, PM, TA, TE, FE and ME. The mechanisation of field operations involves large amounts of diesel and has a remarkable contributions to OD (54%), POF (61%) and MFRD (83%). The drying process is also relevant in terms of OD (41%) and MFRD (14%) due to fuel and electricity consumption. Production of seeds and herbicides plays a minor role (less than 4% for all the environmental impacts evaluated). The application of urban sewage as organic fertiliser involves higher methane emission rates (85 kg/ha·year, about 50% of the total) respect to mineral fertilisation [4].

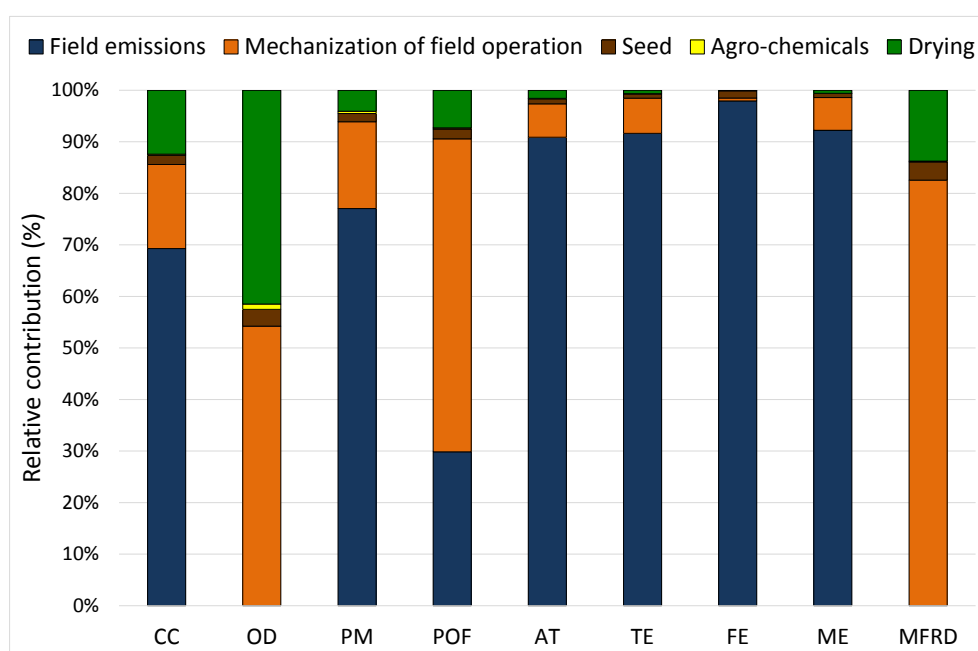

Figure 2: Environmental hotspots

A sensitivity analysis has been carried out considering: (i) minimum and maximum methane emission factors (0.8 and 2.2 kg of CH<sub>4</sub>/ha·day); (ii) minimum (6.33 t/ha, 14% of moisture) and maximum (7.01 t/ha 14% of moisture) grain yields recorded over 3 years. The sensitivity results per functional unit are reported in Table 1.



Impact category	Baseline	Grain yield		Methane emission factor	
		Min	Max	Min	Max
CC	825.7 kg CO <sub>2</sub> eq.	+5.96	-2.24%	-26.64%	+47.9%
OD	3.49E-05 kg CFC-11 eq.	+4.39%	-1.64%	0%	0%
PM	0.499 kg PM <sub>2.5</sub> eq.	+7.26%	-2.73%	0%	0%
POF	2.630 kg NMVOC eq.	+6.91%	-2.60%	-3.79%	+6.83%
TA	19.389 molc H <sup>+</sup> eq.	+7.46%	-2.81%	0%	0%
TE	86.510 molc N eq.	+7.53%	-2.83%	0%	0%
FE	0.294 kg P eq.	+7.58%	-2.85%	0%	0%
ME	8.439 kg N eq.	+7.54%	-2.83%	0%	0%
MFRD	0.0039 kg Sb eq.	+6.44%	-2.42%	0%	0%

Table 1: Sensitivity analysis results

## 6. Conclusion

In this study, the rice cultivation with urban sewage as organic fertiliser was analysed using the LCA methodology. The environmental *hotspots* were methane emissions for CC, nitrogen-based emissions derived from fertilising for FE, TE and ME, the degree of mechanisation (due to diesel use) and grain drying for OD, MFRD and CC. Solutions focused on saving fossil fuel use, reduction of nitrogen-based emissions from fertiliser use and methane emission from biomass fermentation should be implemented in order to improve the environmental performance of rice cultivation.

## 7. References

- [1] USDA, Economic Research Service, Rice Outlook/RCS-14i/September 15, 2014,
- [2] Enterisi, 2014. Riso – Evoluzione di mercato e sue prospettive. Ente Nazionale Risi, Dicembre 2014.
- [3] Blengini, G.A. and Busto, M. The life cycle of rice: LCA of alternative agri-food chain management systems in Vercelli (Italy). *J. Environ. Manage.* 90, (2009) 1512–1522.
- [4] Fusi, A., Bacenetti, J., González-García, S., Vercesi A., Bocchi S., Fiala, M. Environmental profile of paddy rice cultivation with different straw management. *Sci. Total Environ.* 494-495, (2014) 119-128.
- [5] Brentrup, F., Küsters, J, Lammel, J, Kuhlmann, H. Methods to estimate on-field nitrogen emissions from crop production as an Input to LCA studies in the Agricultural Sector. *Int. J. Life Cycle Ass.* 5, (2000) 349-57.
- [6] IPCC, Agriculture, Forestry and Other Land Use. In: Eggleston et al., IPCC Guidelines for National Greenhouse Gas Inventories, Prepared by the National Greenhouse Gas Inventories Programme, 2006.
- [7] Wolf, M.A., Pant, R., Chomkamsri, K., Sala, S., Pennington, D. ILCD handbook- Towards more sustainable production and consumption for a resource efficient Europe. JRC Reference Report, 2012.
- [8] Sleeswijk, A.W., van Oers, L., Guinée, G., Struijs, J., Huijbregts, M. Normalisation in product life cycle assessment: An LCA of the global and European economic systems in the year 2000. *Sci. Total. Environ.* (2008) 390: 227 – 240.
- [9] Capri, E., Karpouzias, D. (2007). Pesticide Risk Assessment in Rice Paddies: Theory and Practice. Elsevier, pp. 266.

# Life Cycle Assessment of Greenhouse-Grown Tomatoes in Thailand

*Davaasuren Dashzegve<sup>1</sup>, Vilas.M.Salokhe<sup>2</sup>, Erik Bohez<sup>2</sup> and Peeyush Soni<sup>2</sup>*

*<sup>1</sup>HSE Management System Coordinator at Mongolian Mining Corporation,  
Ukhaa Khudag Branch, Tsogttsetsii soum, Umnugobi province, Mongolia*

*<sup>2</sup>Professor, Vice Chancellor at Kaziranga University, Koraikhowa, NH-37, Jorhat, Assam 785006, India*

*<sup>2</sup>Professor at Asian Institute of Technology, 58 Moo 9, Km. 42, Paholyothin Highway*

*<sup>2</sup>Associate Professor at Asian Institute of Technology,*

*58 Moo 9, Km. 42, Paholyothin Highway, Klong Luang, Pathumthani 12120, Thailand*

*E-mail contact: davaasuren.d@mmc.mn; salokhe.vilas@gmail.com; bohez@ait.asia; soni@ait.asia;*

## 1. Abstract

*LCA Study was carried out to assess greenhouse-grown tomatoes in Thailand. The functional unit of this study was 1 kg of tomato and the system boundary was cradle to packaging plant gate of greenhouse tomato fruits (seedling process to packaging process), which includes seedling, growing harvesting and packaging process. Limitations of this study are transportation processes of products to the market and food storage of tomato products; neither of which was included in this study. Moreover, no waste scenario analysis of product system was studied.*

*Keywords: Life cycle assessment, functional unit, greenhouse, tomato.*

## 1. Introduction

LCA can assist to identify opportunities to improve the environmental performance of products at various points in their life cycle and to inform decision-makers in industry, government or non-government organizations. Often the most important goal of a life cycle study is to improve and optimize the system.

## 2. Literature Review

The LCA of organic, recirculation and standard greenhouse tomato production were conducted by LCA Food DK in 2005. There have included and analyzed energy inputs such as water, nitrogen and phosphorus of fertilizers, electricity, substrate and covering (nylon) of greenhouse out of infrastructure material inputs. In those researches, second order of LCA has been applied to the greenhouse tomato production and functional unit of their study was 1 kg of tomato same as other researches (SimaPro 7.1)

## 3. Life Cycle Impact Assessment Method and Software

The third order LCA was applied in this study by using SimaPro 7.1 software. The eco-Indicator 99H/H life cycle impact assessment (LCIA) method was selected to evaluate the environmental impacts of greenhouse grown tomatoes. LCIA was based on both the characterization and single score elements. The selected impact categories of Eco-Indicator 99 method were carcinogens, respiratory organic and inorganics, climate change, radiation, ozone layer, acidification and ecotoxicity, land use, mineral, fossil fuels.

## 4. Unit Process and Inputs

In this study, there are two main inventory inputs which are from experimental site and from LCI databases. The following figure shows the system boundary of this study and relevant inputs and outputs of greenhouse tomato products throughout its life cycle in the experimental site.

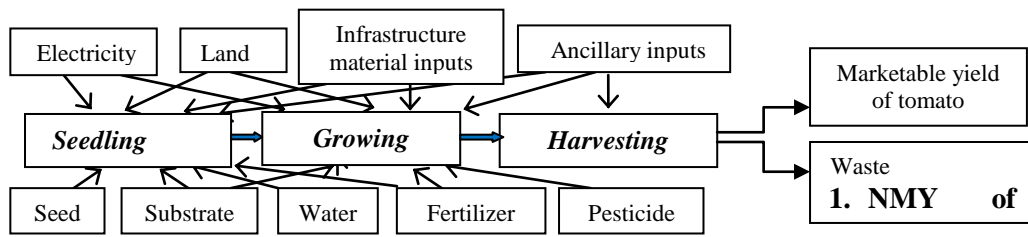

Figure 1: System boundary of Greenhouse tomato production in LCA

LCI results modeled in SimaPro within system being studied by each unit process such as seedling process, growing process and packaging process as a whole system process of greenhouse grown tomatoes as well.

#### Calculation of inventory input quantities per FU

Energy and some ancillary material inputs were calculated by the following method. It included seed, substrate, water, fertilizer, pesticide and electricity. In addition, seed trays, disposable gloves, isolation gown, cotton string, plastic bag and paper box were also included.

$$\text{Quantity per FU} = \text{quantity of input} / \text{TMY}$$

(TMY – Total marketable yield)

Infrastructure and ancillary material inputs of each unit process and system process were calculated by two different categories. Infrastructure and ancillary material inputs of each unit process and system process excluding nursery infrastructure inputs and drip irrigation equipments were calculated following equation.

$$\text{Quantity per FU} = \text{quantity of input} / \text{ELT} / \text{related TMY}$$

(ELT – Expected life time)

### 5. Life Cycle Impact Assessment and Results

LCIA in the overall process, analyzing 1 kg of tomato as a single score of LCIA elements is shown in Figure 2.

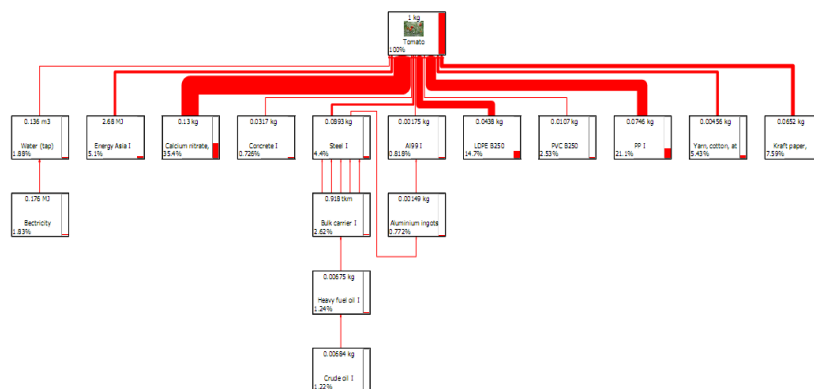

Figure 2: Single score results for analyzing 1 kg of tomato in the overall process

In the overall process, according to the impact analysis of 1 kg of tomato the highest impact on the environment is due to calcium nitrate (35.4%) as the fertilizer needs to be applied throughout the growing process which constitutes more than 70% of the total life cycle.

According to the characterization results of overall process in each impact categories are expressed as percentages for analyzing 1 kg of tomato. It is shown in Figure 3.

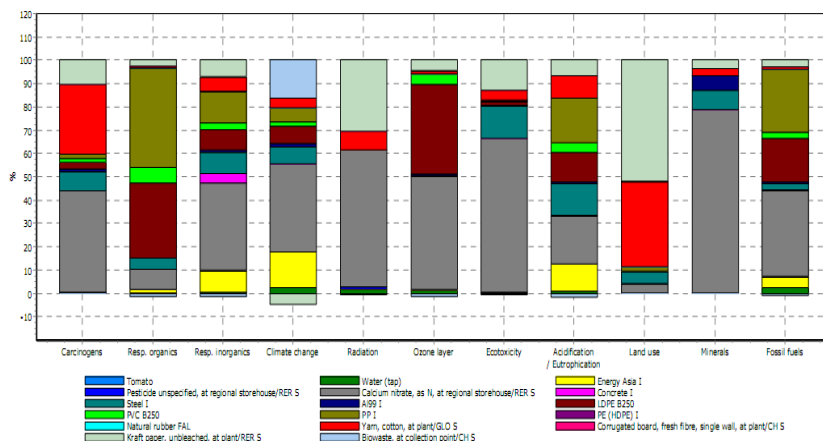
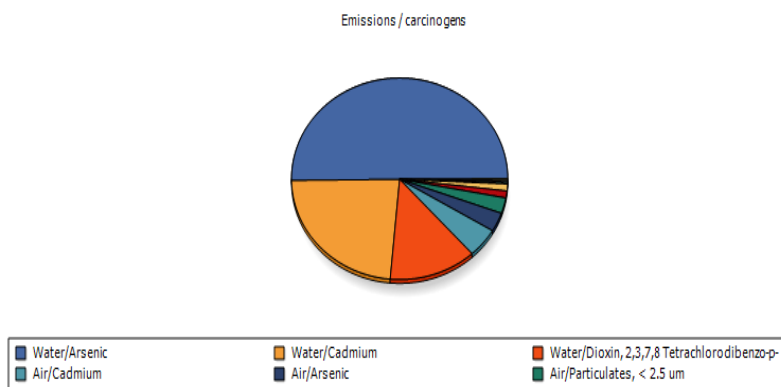

Figure 3: The characterization results for analyzing the impact of 1 kg of tomato

As can be seen from Figure 4.2, most environmental impact is caused by calcium nitrate which affects all impact categories. It's highest impact was on the minerals which contributed 78.8% of total inventory results of this study. Calcium nitrate also was shown to have 66.2% of impact on the ecotoxicity and radiation (59.4%), ozone layer (47.3%), carcinogens (43.6%), climate change (39.2%), respiratory inorganics (37.4%) and fossil fuels (36.6%).

The second highest environmental impact comes from LDPE, for which the highest impact was on the ozone layer, which was 41.5% of total inventory results. And the next impact of LDPE was on the respiratory inorganics (34.4%). The direct emissions of product system to air, water and soil is shown in below figure.



Method: Eco-indicator 99 (H) LCA Food V2.03 / Europe EI 99 H/A / Characterization Analyzing 1 kg 'Greenhouse tomato';

Figure 4: The direct emissions under the carcinogens category

The comparison of product system (greenhouse tomato) within the same functional unit by using single score with three other projects (standard tomato, recirculation tomato and organic tomato in that SimaPro software) was done. The purpose of the comparison is to determine whether this project has the higher or lower impact on the environment compared to the three other projects. The comparison of product system with other project is shown in below figure.

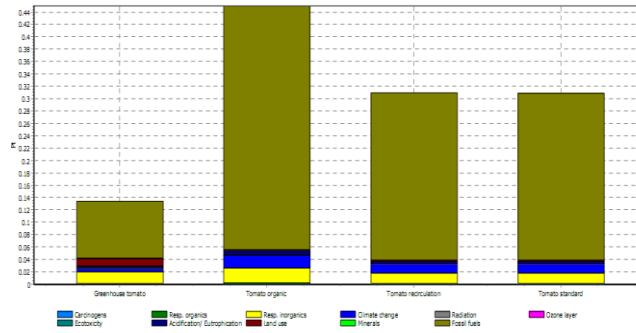

Figure 5: The comparison of product system with other project

As can be seen from the Figure 4.4, it is evident that this project has lowest impacts on the environment compared to three other projects. All the four projects have highest impact on the fossil fuels followed by respiratory inorganics and climate change.

## 6. Conclusions

In agreement with analysis of characterization, the greatest impact of greenhouse grown tomatoes on the environment taking into consideration human health, ecosystem and resources the study found that calcium nitrate has the highest impact, the next LDPE and then by cardboard packaging box. Moreover, Polypropylene (PP) and yarn cotton are considerable impacts on the environment.

According to the analysis of single score, most significant environmental impact of greenhouse grown tomatoes is caused by calcium nitrate. The followed highest impacts on the environment are PP and LPDE which are non-biodegradable in nature and a major cause of environmental pollution.

## 7. Recommendations

It is therefore, the impact on environment can be reduced more by avoiding the usage of calcium nitrate or other inorganic fertilizers. If efforts are made to substitute the inorganic fertilizers by organic ones which has the same amount of nutrition required by the tomato plant the impact on the environment can be reduced to a great extent.

Similarly, using greenhouse covering materials which have high expected life time can also reduce the impact on environment.

## 8. References

- [1] Anton, A., Juin, I., Montero, and Munoz, P., 'LCA and tomato production in Mediterranean greenhouses' (2005).
- [2] ISO 14040:2006 'Environmental management - Life cycle assessment - Principles and framework'.
- [3] ISO 14044:2006 'Environmental management - Life cycle assessment - Requirements and guidelines'.
- [4] Medina, A., Cooman, A., Parrado, C.A., and Schrevens, E., 'Evaluation of energy use and some environmental impacts for greenhouse tomato production in the high altitude tropics' (2008).
- [5] Parrado, C.A., Bojaca, C., and Monsalve, O., 'Environmental impact of greenhouse tomato production systems in Colombia using life cycle approach'. 6th International Conference on LCA in the Agri-Food sector. (2008) 85p.
- [6] Pluimers, J.C., Kroeze, C., 'Quantifying the environmental impact of production in agriculture and horticulture in The Netherlands'. *Agricultural Systems* 66 (2000) (167-189p).

# The evolution of LCA in milk production

Cecilia, Baldini<sup>1</sup>; Davide, Gardoni<sup>2</sup>; Marcella, Guarino<sup>2</sup>

<sup>1</sup>Doctoral school of Environmental Sciences, Department of Biosciences, University of Milan,  
via Celoria, 26-20133 Milan, Italy.

<sup>2</sup>Department of Health, Animal Science and Food Safety, University of Milan, via Celoria, 10-20133 Milan, Italy  
E-mail contact: cecilia.baldini@unimi.it

## 1. Abstract

*The comparison among different LCA studies is challenging. Analyzing 29 original articles selected among LCAs related to milk production, we evaluated their level of harmonization and the uniformation to the major standards currently available for the milk sector.*

## 2. Introduction

In the last fifteen years the Life Cycle Assessment (LCA) became well established also in the dairy sector. The main strength of the LCA methodology is its versatility, which makes it potentially applicable to all production processes. However, the major weakness of this approach is the comparability among different studies, caused by the generic principles of the ISO standards (ISO 2006: 14040 and 14044) and the wide range of leeway given to operators. In 2010 the International Dairy Federation (IDF) issued a specific guideline for the dairy sector [1]. Despite being limited to the calculation of the carbon footprint, this document could be considered a step forward for the harmonization of milk production LCAs, since it outlines a common strategy to handle some critical points that are peculiar of this sector. The aim of our review is to describe the evolution of recent LCA studies related to milk production (published in the last 5 years), in order to underline trends and/or arising questions. Furthermore, we also aimed at verifying if the implementation of the IDF document actually improved the comparability of the results of different works.

## 3. Methods

Scientific literature was checked using the keywords “dairy LCA” and “Life Cycle Assessment dairy farms” on different databases (Scopus and ISI Web of Knowledge). The papers are selected according to the following criteria:

- They must be written in English and published after 2009.
- They must be related to milk production from cattle systems. Studies related to processed milk were retrieved whereas studies related to other dairy products were dismissed.
- They must consider more than one impact category (considering also technical quantities, i.e. land use and non-renewable energy consumption).

The studies were analyzed tracing the LCA phases identified by the ISO standards.

## 4. Results

The selected papers are 29 [2-31]. In order to check the standardization among studies, we verified if the selected papers referred or not to the ISO standards and to the IDF guideline. Unexpectedly only 60% of authors reported the ISO standard in their bibliography and the percentage of citation of the IDF guideline was even lower (40% of papers, considering only those published after 2010). The relatively recent publication of the IDF document could be a cause of the scarce application of this guideline.

#### 4.1 Impact coverage

The global warming potential (GWP) is the most widely studied impact category (100% of selected studies). Other commonly considered environmental problems are the acidification potential (76%), eutrophication potential (72%), land use (72%) and energy use (59%). Finally, less investigated impact categories are (in decreasing order): ecotoxicity, photochemical ozone formation, human toxicity, ozone depletion, abiotic depletion. Interesting and emerging topics not sufficiently addressed are: land use change (20% of studies, of which only the half provided quantitative results), biodiversity loss (considered just by Guerci, et al. [13]) and water consumption (investigated in no one of the selected papers since *ad hoc* studies are more frequent).

#### 4.2 Functional unit

The functional unit is the reference to which the inputs and the outputs should be related, and constitutes the basis for comparability among different studies. In milk LCA various functional units could be used, according to the “milk function” that the authors decide to highlight. Among selected studies, the 21% of authors focused on production and used the quantity (mass or volume) of raw or processed milk as functional unit. On the contrary, the 79% of authors highlighted the nutritional function of milk and corrected the raw production according to its energy content, using the Fat and Protein Corrected Milk formula (FPCM) (32% of authors) or the Energy Corrected Milk formula (ECM) (47% of authors). These two equations employ slightly different coefficients to express the mass (kg) of milk required to provide the same energy amount produced by a standard milk (4% of fat and 3.3% of protein content). Furthermore, a useful way to emphasize other aspects related to milk production, mainly the land use, is to express the LCA results through different functional units (32% of authors). This practice helps to take into account the local aspects related to some impact category (in particular to acidification and eutrophication) and to deepen the environmental consequences of intensification. In fact, the selection of a relative metric based only on quantity of product, implicitly endorses an economic model predicted on growth [32].

#### 4.3 Allocation rules and system boundaries

A discussed topic in LCA is the allocation of environmental impacts among the co-products of milk production (milk, calves, cull cows). In the selected studies, we analyzed the rules applied to allocate burdens between milk and live animals. Some papers don't report this information [9, 16, 25], while some authors compare different allocation rules to understand their influence on the results [3, 5, 14, 17, 20], hence a total of 39 cases were extracted. Within this group, 38% used an economic allocation, the 18% chose the biological allocation recommended by IDF, the 15% attributed the whole environmental impact to milk, while a minor proportion of authors chose mass allocation, system expansion, protein content of milk or other methods of allocation (respectively 8%, 5%, 5% and 10% of cases). The definition of system boundaries is another important issue for the comparison of LCA results. Overlooking the free choice of considering the whole system “from cradle to grave” or focusing on a “cradle to gate” study, we would like to stress the importance of giving an accurate definition of the system boundaries using a sufficiently detailed flow diagram, as suggested by ISO. The scheme helps the reader to catch all the important data

about the considered system, while a mere description in the text, although very detailed, makes difficult the extrapolation of unambiguous information. A good example of diagram flow is reported in Jan et al. [16].

#### 4.4 Life Cycle Inventory (LCI) and Life Cycle Impact Assessment (LCIA)

Data gathering is considered as the most demanding task in conducting an LCA study, and major attention is usually paid to data quality. Among considered studies, the 52% collected foreground data from real farms, while a minor proportion of authors used average or literature data (respectively 24% and 24% of studies). Regarding the background data, including equations used to estimate the emission factors, information are often incomplete. Nevertheless we observed a high degree of convergence in the GHG estimation, for which IPCC equations are usually adopted. On the other hand, there is a larger spectrum of equation used for the estimation of NH<sub>3</sub> emissions while the P losses had generally a low level of detail [28]. Concerning the LCIA method employed to implement the analysis, the CML is surely the most adopted method (55% of studies). Also in this case we encountered some difficulties in the reconstruction of statistics, since the information about the LCIA method is not uniformly reported (some authors declare the method, others refer to the model used to characterize the environmental problem).

### 5. Conclusions

We identified suggestions regarding how future LCAs of dairy sector should be developed:

- A broad range of impact categories limits the shifting of the targeted environmental problems. Global warming potential, acidification, eutrophication and energy use are the most frequently evaluated impact categories, while hotspots that need an in-depth analysis are land use change, biodiversity, ecotoxicity and water use.
- The choice of a common functional unit (such as FPCM, as recommended by IDF) would allow a direct evaluation of the results of different studies, although with different assumptions.
- A sufficiently detailed description of the system boundaries should be followed by a flow diagram, in order to help the reader to promptly find out the main information.
- Data taken from real farms greatly improve the quality of the study, and should be preferred to literature data.
- With the aim to improve transparency, the methods for the calculation of the derived impacts should be explicitated in the text.
- If possible, selected emission factors should be site-specific and a table resuming the equations used for their calculation would be appreciated.
- The sensitivity analysis should be systematically conducted and the uncertainties associated to the selected input data should be quantified, since the methodology choices used for the assessment have a large effect on the final result.

### 6. References

- [1] IDF, 'A common carbon footprint approach for dairy - The IDF guide to standard life cycle assessment methodology for dairy sector', International Dairy Federation, 2010.
- [2] Arsenault, N., Tyedmers, P. and Fredeen, A., 'Comparing the environmental impacts of pasture-based and confinement-based dairy systems in Nova Scotia (Canada) using life cycle assessment', *Int. J. Agric. Sustain.* 7 (1) (2009) 19-41.
- [3] Bartl, K., Gómez, C. A. and Nemecek, T., 'Life cycle assessment of milk produced in two smallholder dairy systems in the highlands and the coast of Peru', *J. Clean. Prod.* 19 (13) (2011) 1494-1505.
- [4] Basset-Mens, C., Ledgard, S. and Boyes, M., 'Eco-efficiency of intensification scenarios for milk production in New Zealand', *Ecol. Econ.* 68 (6) (2009) 1615-1625.



- [5] Battini, F., Agostini, A., Boulamanti, A. K., Giuntoli, J. and Amaducci, S., 'Mitigating the environmental impacts of milk production via anaerobic digestion of manure: Case study of a dairy farm in the Po Valley', *Sci. Total Environ.* 481 (1) (2014) 196-208.
- [6] Bava, L., Sandrucci, A., Zucali, M., Guerci, M. and Tamburini, A., 'How can farming intensification affect the environmental impact of milk production?', *J. Dairy Sci.* 97 (7) (2014) 4579-4593.
- [7] Castanheira, É., Dias, A. C., Arroja, L. and Amaro, R., 'The environmental performance of milk production on a typical Portuguese dairy farm', *Agr. Syst.* 103 (7) (2010) 498-507.
- [8] Chen, X. and Corson, M. S., 'Influence of emission-factor uncertainty and farm-characteristic variability in LCA estimates of environmental impacts of French dairy farms', *J. Clean. Prod.* 81 (2014) 150-157.
- [9] Djekic, I., Miocinovic, J., Tomasevic, I., Smigic, N. and Tomic, N., 'Environmental life-cycle assessment of various dairy products', *J. Clean. Prod.* 68 (2014) 64-72.
- [10] Fantin, V., Buttol, P., Pergreffi, R. and Masoni, P., 'Life cycle assessment of Italian high quality milk production. A comparison with an EPD study', *J. Clean. Prod.* 28 (2012) 150-159.
- [11] González-García, S., Castanheira, T. G., Dias, A. C. and Arroja, L., 'Using Life Cycle Assessment methodology to assess UHT milk production in Portugal', *Sci. Total Environ.* 442 (2013) 225-234.
- [12] Guerci, M., Bava, L., Zucali, M., Sandrucci, A., Penati, C. and Tamburini, A., 'Effect of farming strategies on environmental impact of intensive dairy farms in Italy', *J. Dairy Res.* 80 (3) (2013) 300-308.
- [13] Guerci, M., Knudsen, M. T., Bava, L., Zucali, M., Schönbach, P. and Kristensen, T., 'Parameters affecting the environmental impact of a range of dairy farming systems in Denmark, Germany and Italy', *J. Clean. Prod.* 54 (2013) 133-141.
- [14] Heller, M. C. and Keoleian, G. A., 'Life cycle energy and greenhouse gas analysis of a large-scale vertically integrated organic dairy in the United States', *Environ. Sci. Technol.* 45 (5) (2011) 1903-1910.
- [15] Iribarren, D., Hospido, A., Moreira, M. T. and Feijoo, G., 'Benchmarking environmental and operational parameters through eco-efficiency criteria for dairy farms', *Sci. Total Environ.* 409 (10) (2011) 1786-1798.
- [16] Jan, P., Dux, D., Lips, M., Alig, M. and Dumondel, M., 'On the link between economic and environmental performance of Swiss dairy farms of the alpine area', *Int. J. Life Cycle Ass.* 17 (6) (2012) 706-719.
- [17] Kristensen, T., Mogensen, L., Knudsen, M. T. and Hermansen, J. E., 'Effect of production system and farming strategy on greenhouse gas emissions from commercial dairy farms in a life cycle approach', *Livest. Sci.* 140 (1-3) (2011) 136-148.
- [18] Meul, M., Van Middelaar, C. E., de Boer, I. J. M., Van Passel, S., Fremaut, D. and Haesaert, G., 'Potential of life cycle assessment to support environmental decision making at commercial dairy farms', *Agr. Syst.* 131 (2014) 105-115.
- [19] Nguyen, T. T. H., Corson, M. S., Doreau, M., Eugène, M. and Van Der Werf, H. M. G., 'Consequential LCA of switching from maize silage-based to grass-based dairy systems', *Int. J. Life Cycle Ass.* 18 (8) (2013) 1470-1484.
- [20] Nguyen, T. T. H., Doreau, M., Corson, M. S., Eugène, M., Delaby, L., Chesneau, G., Gallard, Y. and Van Der Werf, H. M. G., 'Effect of dairy production system, breed and co-product handling methods on environmental impacts at farm level', *J. Environ. Manage.* 120 (2013) 127-137.
- [21] O'Brien, D., Shalloo, L., Patton, J., Buckley, F., Grainger, C. and Wallace, M., 'A life cycle assessment of seasonal grass-based and confinement dairy farms', *Agr. Syst.* 107 (2012) 33-46.
- [22] Penati, C. A., Tamburini, A., Bava, L., Zucali, M. and Sandrucci, A., 'Environmental impact of cow milk production in the central Italian Alps using Life Cycle Assessment', *Ital. J. Anim. Sci.* 12 (4) (2013) 584-592.
- [23] Roer, A. G., Johansen, A., Bakken, A. K., Daugstad, K., Fystro, G. and Strømman, A. H., 'Environmental impacts of combined milk and meat production in Norway according to a life cycle assessment with expanded system boundaries', *Livest. Sci.* 155 (2-3) (2013) 384-396.
- [24] Ross, S. A., Chagunda, M. G. G., Topp, C. F. E. and Ennos, R., 'Effect of cattle genotype and feeding regime on greenhouse gas emissions intensity in high producing dairy cows', *Livest. Sci.* 170 (2014) 158-171.
- [25] Sasu-Boakye, Y., Cederberg, C. and Wirsenius, S., 'Localising livestock protein feed production and the impact on land use and greenhouse gas emissions', *Animal.* 8 (8) (2014) 1339-1348.
- [26] Thomassen, M. A., Dolman, M. A., van Calster, K. J. and de Boer, I. J. M., 'Relating life cycle assessment indicators to gross value added for Dutch dairy farms', *Ecol. Econ.* 68 (8-9) (2009) 2278-2284.
- [27] van der Werf, H. M. G., Kanyarushoki, C. and Corson, M. S., 'An operational method for the evaluation of resource use and environmental impacts of dairy farms by life cycle assessment', *J. Environ. Manage.* 90 (11) (2009) 3643-3652.
- [28] Yan, M. J., Humphreys, J. and Holden, N. M., 'An evaluation of life cycle assessment of European milk production', *J. Environ. Manage.* 92 (3) (2011) 372-379.
- [29] Yan, M. J., Humphreys, J. and Holden, N. M., 'Evaluation of process and input-output-based life-cycle assessment of Irish milk production', *J. Agric. Sci.* 151 (5) (2013) 701-713.
- [30] Yan, M. J., Humphreys, J. and Holden, N. M., 'Life cycle assessment of milk production from commercial dairy farms: The influence of management tactics', *J. Dairy Sci.* 96 (7) (2013) 4112-4124.
- [31] Zehetmeier, M., Hoffmann, H., Sauer, J., Hofmann, G., Dorfner, G. and O'Brien, D., 'A dominance analysis of greenhouse gas emissions, beef output and land use of German dairy farms', *Agr. Syst.* 129 (2014) 55-67.
- [32] Garnett, T., 'Three perspectives on sustainable food security: Efficiency, demand restraint, food system transformation. What role for life cycle assessment?', *J. Clean. Prod.* 73 (2014) 10-18.

# Dairy products: Energy use and the associated greenhouse gas emissions

Alessandra Fusi<sup>1</sup>, Baboo Gowreesunker<sup>2</sup>, Savvas Tassou<sup>2</sup>, Adisa Azapagic<sup>1</sup>

<sup>1</sup>School of Chemical Engineering and Analytical Science, The University of Manchester, The Mill, Sackville Street, Manchester, M13 9PL, UK

<sup>2</sup>School of Engineering and Design, Brunel University, Uxbridge, Middlesex UB8 3PH, UK

Email contact: [alessandra.fusi@manchester.ac.uk](mailto:alessandra.fusi@manchester.ac.uk)

Tel: +44 (0) 161 306 8834

## 1. Abstract

About 30% of global energy is consumed in the agricultural and food sector. This paper focuses on the dairy industry with the aim of quantifying energy consumption and associated greenhouse gas (GHG) emissions for different dairy products across their life cycle. The hotspots are also discussed to help identify improvement opportunities along the supply chain. The results indicate that milk is the least energy-intensive product, while cheese and milk powder have on average the highest energy demand. A similar pattern applies for the GHG emissions. The production of the raw milk and its processing are the major energy and GHG hotspot for all the dairy products. Energy used for consumer transport and related GHG emissions are also significant for milk.

## 2. Introduction

About 30% of global energy is consumed in the agricultural and food sector [1], contributing around 20% to the total GHG emissions [2]. Energy is used and GHG emitted at every stage of the food value chain, from the production of agricultural inputs to consumption of food. Among others, dairy is an important food sub-sector with milk being one of the most consumed food products globally [3]. However, the data on energy use and GHG emissions across the life cycle of different dairy products vary widely depending on the type of product, source and assumptions. Furthermore, most sources only focus on a specific product and, as far as the authors are aware, there are no publications which consider energy and associated GHG emissions for the whole range of dairy products. Therefore, this paper aims to collate that information and estimate life cycle energy consumption and related GHG emissions for different dairy products as well as to identify the hotspots to guide future improvements.

## 3. Methods

The following dairy products are considered: milk, cheese, butter, yogurt, milk powder, cream and ice cream. The whole life cycle of these products has been evaluated, from raw materials production, to post-consumer waste management, including packaging and waste product disposal (Figure 1).

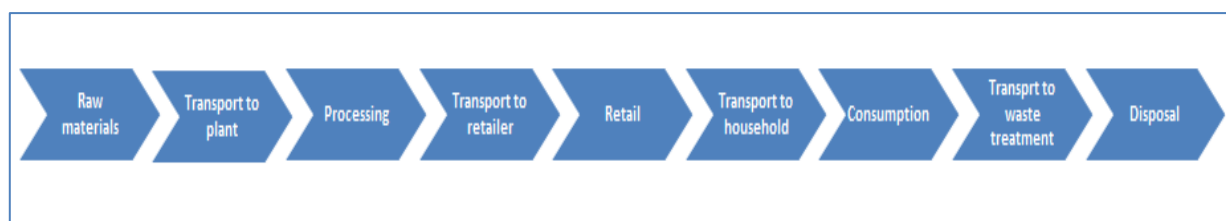

Figure 1: The life cycle of dairy products considered in this study

The energy consumption and the associated GHG emissions for the production of raw milk at the farm include cereals cultivation and fodder production for cows. For the processing stage, both thermal and electrical energy for the production of the final product and of its primary packaging are considered. Energy requirements and related GHG emissions at the retailer include electricity for refrigeration (both in walk-in storage cells and display cabinets), electricity for lighting and ventilation and gas for space conditioning (refrigerant production and leakage are excluded). Fuel consumption is considered for both ambient and refrigerated transport. Data have been sourced from the literature [4-11]. However, for consumer transport as well as consumption of products scant data have been available so that they have been estimated as part of this study as follows.

Fuel use for the transport to households has been calculated assuming the UK conditions, based on:

- The composition of the UK weekly food basket by weight [12];
- The average distance covered in the UK per week for food shopping [13];
- The share of km travelled by car and by bus for food shopping [13]; and
- The amount of fuel per km consumed by passenger cars and buses [14].

The data for the consumption stage have been calculated based on:

- The average daily energy consumption of domestic refrigerators/freezers [15];
- The volume of domestic refrigerators/freezers [14];
- The volume occupied by 1 kg of the product; and
- The average food storage time [16-17].

For waste management, the amount of waste and its disposal have been assumed based on the UK statistics for food waste [18-19].

To estimate the GHG emissions associated with energy use in the life cycle of different products, the following GHG emission factors are assumed: for electricity, 0.14 kg CO<sub>2</sub> eq./MJ, for diesel, 2.67 kg CO<sub>2</sub> eq./l and for natural gas, 0.056 kg CO<sub>2</sub> eq./MJ [10]. For context, in addition to the GHG related to energy use, the total amount of CO<sub>2</sub> eq. emitted across the whole life cycle is also indicated, based on [20-21].

#### **4. Results**

Table 1 presents the total energy requirements and associated GHG emissions for milk, cheese, butter, yogurt, milk powder, cream and ice cream. Total GHG emissions along the life cycle are indicated in brackets. As can be seen in the table, milk is the least energy-intensive product, while cheese and milk powder have the highest energy demand, followed by butter. A similar pattern is found for the related GHG emissions. However, as also evident from the table, the estimates range widely in different sources, with the greatest variation noticed for cheese. This is due to the large assortment of cheese types, which have different yield from raw milk and require different maturing time: the majority of the variation is in raw milk production and processing.

Product	Energy (MJ/kg)	GHG emissions <sup>a</sup> (kg CO <sub>2</sub> eq./kg)
Milk	4.86-10.08	0.45-0.789 (1 <sup>b</sup> -1.23 <sup>c</sup> )
Cheese	22.40-63.92	2.05-5.65 (4.9 <sup>c</sup> -11 <sup>b</sup> )
Butter	9.42-20.79	0.90-1.86 (8.9 <sup>b</sup> -10.9 <sup>c</sup> )
Yogurt	6.25-11.81	0.56-1.09 (1.52 <sup>c</sup> -2.4 <sup>b</sup> )
Milk powder	24.93-40.93	1.96-3.42 (8.6 <sup>c</sup> )
Cream	6.36-13.89	0.56-1.14 (5.5 <sup>c</sup> -5.6 <sup>b</sup> )
Ice cream	11.43-15.41	(4 <sup>b</sup> )

<sup>a</sup> Values without brackets represent the emissions related to energy consumption in the life cycle of dairy products while those in brackets are the total life cycle GHG emissions.

<sup>b</sup> Sourced from [20].

<sup>c</sup> Sourced from [21].

*Table 1: Total energy requirements and the associated GHG emissions in the life cycle of dairy products*

The stages which contribute most to the energy consumption and the related GHG emissions are the raw milk production (on average 52%) and processing (16%). In the case of ice cream, the frozen storage at retailer is the most significant (up to 32%). For milk, consumer transport is also a hotspot, contributing up to 19% of the total. This is because milk represents 13.5% by weight of the UK weekly food basket and 13.6 km are travelled on average every week for food shopping [12]. On the other hand, when considering the total life cycle GHG emissions, not just the energy-related, milk has the lowest CO<sub>2</sub> eq. and butter and cheese the highest.

## 5. Conclusions

This study has aimed to quantify energy consumption and the related GHG emissions as well as identify the hotspots for different dairy products across their life cycle. The results suggest that milk is the least energy demanding while cheese and milk powder are the most energy-intensive products, followed by butter. A similar trend applies to the GHG emissions. The life cycle stages which contribute most to energy consumption and to the related GHG emissions are the production of milk at farm and its subsequent processing. Frozen storage of ice cream at retailer is a hotspot for ice cream and consumer transport for milk. Therefore, these stages should be targeted for reduction of energy and GHG emissions in the dairy sector.

## 6. References

- [1] FAO, 2011. Energy-smart food for people and climate – issue paper. <http://www.fao.org/docrep/014/i2454e/i2454e00.pdf>.
- [2] Sonnesson U., Belin J., Ziegler F., 2010. Environmental assessment and management in the food industry – life cycle assessment and related approaches. Elsevier Book, 2010.
- [3] FAO, 2012. Milk availability – trends in production and demand and medium-term outlook. <http://www.fao.org/docrep/015/an450e/an450e00.pdf>
- [4] DEFRA, 2006. Environmental impacts of food production and consumption. <http://www.ifr.ac.uk/waste/Reports/DEFRA-Environmental%20Impacts%20of%20Food%20Production%20%20Consumption.pdf>.
- [5] Berlin J., 2002. Environmental life cycle assessment (LCA) of Swedish semi-hard cheese. *International Dairy Journal*, 11: 939-953.
- [6] Cederberg C., Mattsson B., 2000. Life cycle assessment of milk production – a comparison of conventional and organic farming. *Journal of Cleaner Production*, 8: 49-60.
- [7] European Commission, 2006. Best available techniques in the food, drink and milk industries. [http://eippcb.jrc.ec.europa.eu/reference/BREF/fdm\\_bref\\_0806.pdf](http://eippcb.jrc.ec.europa.eu/reference/BREF/fdm_bref_0806.pdf).
- [8] FAO, 1992. Utilization of renewable energy sources and energy-saving technologies by small-scale milk plants and collection centres. <http://www.fao.org/docrep/004/t0515e/T0515E00.htm#TOC>.
- [9] Nielsen P.H., Nielsen A.M., Weidema, B.P., Dalgaard, R. and Halberg, N., 2003. LCA food database. [www.lcafood.dk](http://www.lcafood.dk).
- [10] DEFRA, 2008. Greenhouse gas impacts of food retailing. Defra research project FO 0405. Department for the Environment Food and Rural Affairs, London. [www.defra.gov.uk](http://www.defra.gov.uk).
- [11] Thomassen M.A., Van Calster K.J., Smits M.C.J., Iepema G.L., De Boer I.J.M., 2008. Life cycle assessment of conventional and organic milk production in the Netherlands. *Agricultural Systems*, 96: 95–107.
- [12] DEFRA, 2014. Family food 2013. Department for Environment, Food and Rural Affairs, London. [www.defra.gov.uk](http://www.defra.gov.uk).
- [13] Pretty J.N., Ball A.S., Lang T., Morison J.I.L., 2005. Farm costs and food miles: an assessment of the full cost of the UK weekly food basket. *Food Policy*, 30: 1–19.
- [14] Frischknecht R., Jungbluth N., Althaus H.J., Doka G., Heck T., Hellweg S., Hischier R., Nemecek T., Rebitzer G., Spielmann M., Wernet G., 2007. Overview and methodology. *Ecoinvent report No. 1*. Swiss Centre for Life Cycle Inventories, Dübendorf.
- [15] Zimmermann J.P., Evans M., Griggs J., King N., Harding L., Roberts P., Evans C., 2012. Household electricity survey: a study of domestic electrical product usage. 600 pgs. Copyright @ 2012 AEA.
- [16] WRAP, 2010. Reducing food waste through the chill chain, Part 1: Insights around the domestic refrigerator. <http://www.wrap.org.uk/sites/files/wrap/Reducing%20food%20waste%20through%20the%20chill%20chain.pdf>.
- [17] WRAP, 2010. Understanding consumer use of the freezer. <http://www.wrap.org.uk/sites/files/wrap/Understanding%20consumer%20use%20of%20the%20freezer.pdf>
- [18] WRAP, 2009. Household food and drink waste in the UK. [http://www.wrap.org.uk/sites/files/wrap/Household\\_food\\_and\\_drink\\_waste\\_in\\_the\\_UK\\_-\\_report.pdf](http://www.wrap.org.uk/sites/files/wrap/Household_food_and_drink_waste_in_the_UK_-_report.pdf).
- [19] Choate A., Pederson L., Scharfenberg J., ICF Consulting, Ferland H., 2005. Waste management and energy savings: benefits by the numbers. U.S. Environmental Protection Agency. <http://www.epa.gov/climatechange/wycd/waste/downloads/Energy%20Savings.pdf>.
- [20] Sheane R., Lewis K., Hall P., Holmes-Ling P., Kerr A., Stewart K., Webb D., 2011. Identifying opportunities to reduce the carbon footprint associated with the Scottish dairy supply chain –main report. Edinburgh: Scottish Government.
- [21] Flysjö A., 2012. Greenhouse gas emissions in milk and dairy product chain. PhD Thesis, Aarhus University, Department of Agroecology Science and Technology.

# Carbon footprint analysis of mozzarella and ricotta cheese production and influence of allocation procedure

*Matteo Simonetto, Anna Mazzi, Andrea Fedel<sup>1</sup>, Chiara Pieretto, Antonio Scipioni*

*CESQA (Quality and Environmental Research Center), University of Padova, Department of Industrial Engineering,*

*Via Marzolo 9, 35131 Padova, Italy*

*E-mail contact: scipioni@unipd.it*

## 1. Abstract

The greenhouse gas emissions deriving from two Italian dairy co-products, mozzarella and ricotta cheese, were assessed according to ISO/TS 14067:2013. Additionally to the assessment of what are the life cycle stages responsible for the most part of the final emissions of each product, the aim of this study was also to evaluate the influence of the allocation procedure applied. The assessment shows that raw materials, production and use stages mainly affect final value of carbon footprint of both the co-products analysed. Moreover, the sensitivity analyses show that a variation of allocation factors at farm level mainly affects only the final value of carbon footprint of mozzarella cheese product, while a variation of allocation factors at production level produces effects on the final value of carbon footprint of both the co-products.

## 2. Introduction

The increasing food consumer awareness of recent years on how food is produced and what are the related environmental impacts generated has led to the development of many studies in the food sector based on the whole supply chain analysis [1] [2]. Some studies adopting life cycle approach provide information about the effects of allocation procedure on final outcomes when considering food products. However they mainly focus on farm level since agricultural systems are particularly sensitive to this kind of approach [3]. This gives the opportunity to investigate the effects on final results when allocation procedures are applied also at production level, especially considering the dairy sector where co-production starting from the same raw material (raw milk) is widely diffused.

## 3. Objectives

In this study a life cycle approach (from cradle to grave) was adopted to evaluate the greenhouse gas emissions, in terms of CO<sub>2</sub> eq, deriving from the production of two Italian dairy co-products: mozzarella and ricotta cheese. The aim of this study was (a) to identify the life cycle stages that mainly affect the value of carbon footprint of each product and (b) to evaluate the influence of allocation procedure on final results through sensitivity analyses.

## 4. Materials & Methods

Since the study focused on two dairy co-products, the functional units considered were two:

- 1kg of mozzarella cheese comprehensive of packaging and delivered to final consumer;
- 1kg of ricotta cheese comprehensive of packaging and delivered to final consumer.

System boundaries were fixed according to the scheme of figure 1.

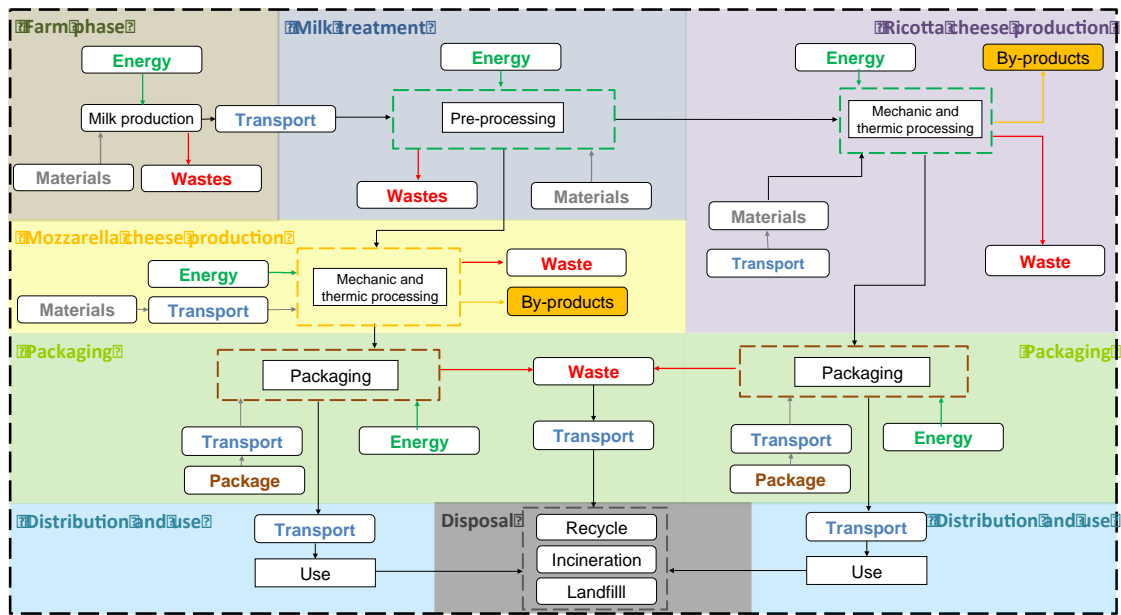

Figure 1: System boundaries of the study

Emissions accounting was performed according to ISO/TS 14067:2013 [4], using the IPCC 2013 GWP 100a impacts assessment method [5]. A biophysical allocation between milk and meat (live weight) was adopted at farm level according to the guidelines of the Bulletin of International Dairy Federation 445/2010 [6], while an allocation by mass of fat was applied at production level, between curd (used to produce mozzarella cheese) and whey (used to produce ricotta cheese) obtained from milk processing. To investigate the effects of the adoption of allocation procedures applied, since they should be avoided in a life cycle based study [7], three sensitivity analysis were performed: in the sensitivity 1 the allocation factor (between milk and meat) of each farmer was fixed to the highest value of them according to the fact that dairy farm system mainly focuses on milk production. Sensitivity 2 and 3 were performed varying the mass of fat content of curd and whey to satisfy the mass balance: sensitivity 2 required an increase of 2% in fat content of curd, while sensitivity 3 required a doubling of the fat content of whey.

## 5. Results and discussion

Results listed in table 1 show a higher carbon footprint value of mozzarella cheese compared to the ricotta cheese one, as well as that raw materials, production and use are the life cycle stages characterized by the highest impact on the total carbon footprint value of both the co-products analysed.

Life cycle stage	Unit	Mozzarella cheese	Ricotta cheese
Raw materials	kg CO <sub>2</sub> eq / F.U.	6,811	0,611
Packaging	kg CO <sub>2</sub> eq / F.U.	0,639	0,433
Production	kg CO <sub>2</sub> eq / F.U.	1,472	1,018
Distribution	kg CO <sub>2</sub> eq / F.U.	0,324	0,126
Use	kg CO <sub>2</sub> eq / F.U.	1,234	0,949
Disposal	kg CO <sub>2</sub> eq / F.U.	0,093	0,076
Total	kg CO <sub>2</sub> eq / F.U.	10,574	3,213

Table 1: Carbon Footprint results listed according to the different life cycle stage and referred to the functional unit of each co-product

Focusing on raw materials of mozzarella cheese, impact value (the highest one) is mainly affected by CH<sub>4</sub> and N<sub>2</sub>O emission at farm level from enteric fermentation and manure management, calculated for this study according to the Tier 1 method proposed by the IPCC [8].

Results from the sensitivity analysis, performed to understand how the allocation procedures may affect the final results, are shown in table 2.

Analysis	Unit	Mozzarella cheese	Ricotta cheese
Baseline	kg CO <sub>2</sub> eq / F.U.	10,574	3,213
Sensitivity 1	kg CO <sub>2</sub> eq / F.U.	11,147	3,257
Sensitivity 2	kg CO <sub>2</sub> eq / F.U.	10,688	3,173
Sensitivity 3	kg CO <sub>2</sub> eq / F.U.	9,824	3,476

Table 2: Variation of final carbon footprint value according to the three different sensitivity analysis

Results from sensitivity 1 show a higher variation, compared to the baseline condition, of mozzarella cheese carbon footprint (+5,42%) than that of ricotta cheese (+1,38%). Sensitivity 2 leads to a small variation of final outcomes (+1,08% for mozzarella cheese, -1,25% for ricotta cheese). Finally, sensitivity 3 shows the most significant incidence on final carbon footprint values (-7,09% for mozzarella cheese, +8,18% for ricotta cheese).

## 6. Conclusion

This study outlines some key aspects characterizing a carbon footprint assessment focused on co-products from dairy sector. Emissions from enteric fermentation and manure management at farm level, because of the allocation (based on fat content) applied at production level between curd and whey, lead to a final carbon footprint of mozzarella cheese higher than the ricotta cheese one. Sensitivity analyses performed show how impacts may change and switch from one co-product to the other, highlighting the importance to have accurate primary data particularly in that kind of study where the adoption of allocation procedures is necessary to have final outcomes consistent with the co-products analysed. An adequate allocation approach is fundamental for the credibility of the study performed, especially in the dairy sector where allocations often occur several times along the supply chain.

## 7. References

- [1] Meissner S.E., Magerholm F.A., 2008. LCA studies of food products as background for environmental product declarations. *International Journal of Life Cycle Assessment* 13 (3), 255–264.
- [2] van der Werf H.M.G., Garnett T., Corson M.S., Hayashi K., Huisingh D., Cederberg C., 2014. Towards eco-efficient agriculture and food systems: theory, praxis and future challenges. *Journal of Cleaner Production*, 73, 1-9.
- [3] Nguyen T.T.H., Doreau M., Corson M.S., Eugène M., Delaby L., Chesneau G., Gallard Y., van der Werf H.M.G., 2013. Effect of dairy production system, breed and co-product handling methods on environmental impacts at farm level. *Journal of Environmental Management*, 120, 127-137.
- [4] ISO/TS, 2013. ISO/TS 14067: Greenhouse Gases e Carbon Footprint of Products e Requirements and Guidelines for Quantification and Communication (Technical Specifications). International Organization for Standardization, Genève.
- [5] IPCC, 2013. *Climate Change 2013: The Physical Science Basis. Contribution of Working Group I to the Fifth Assessment Report of the Intergovernmental Panel on Climate Change*, Cambridge University Press, Cambridge, United Kingdom and New York, NY, USA.



[6] IDF, 2010. A common carbon footprint approach for dairy - The IDF guide to standard life cycle assessment methodology for the dairy sector. Bulletin of the International Dairy Federation (Report 445). Brussels, Belgium: International Dairy.

[7] ISO, 2006. ISO 14044: Environmental Management - Life Cycle Assessment: Requirements and Guidelines. International Organization for Standardization, Genève.

[8] IPCC, 2006. IPCC Guidelines for National Greenhouse Gas Inventories. Agriculture, Forestry and Other Land Use, Vol. 4. Intergovernmental Panel on Climate Change.

# Global warming potential of Lombardy cow milk production at farm

Maddalena Zucali, Alberto Tamburini, Anna Sandrucci, Luciana Bava

Università degli Studi di Milano, Dipartimento di Scienze Agrarie e Ambientali, via Celoria 2, 20133 Milano, Italy

E-mail contact: [luciana.bava@unimi.it](mailto:luciana.bava@unimi.it)

## 1. Abstract

*The objective of the study was to assess the Global Warming Potential (GWP) of the total cow milk production at farm level in Lombardy with an LCA approach starting from survey data. The milk production was obtained from the Italian Breeder's Association and converted as Fat and Protein Corrected Milk (FPCM). The GWP values used were between 1.16 to 1.60 g CO<sub>2</sub> eq/kg FPCM, obtained from previous studies. The total GWP of cow milk production in Lombardy was 5.83 Mt CO<sub>2</sub> eq. corresponding to 1.27% of the total GWP from anthropic activities in Italy and 17% of emissions from agricultural sector. The highest GWP came from Cremona province (26.8% with 27% of production), the lowest from Varese (0.78% with 0.87% of production). The 90% of the total GWP came from plain farms, 5.8% from mountains and 3.4% from hills. Results indicate that in Lombardy the GWP mitigation strategies have to be mainly applied to lowland farms. Moreover it is important to consider that the GWP from milk production sector is much lower than GWP from other anthropic activities.*

## 2. Introduction

In Italy the total greenhouse gas (GHG) emission from anthropic and non-anthropic activities in 2013 was 460 Mt CO<sub>2</sub> equivalents. In particular the agriculture sector contributed to the 7.5% of total national GHG [1] and the most important gases were carbon dioxide, methane and nitrous oxide. The largest part of methane results from digestive processes in ruminant animals, as dairy cows and beef cattle. The GHG emissions produced by the dairy chain comes mainly (about 76%) from the production of milk, while milk processing is less important [2]. According to CLAL [3] the contribution of Lombardy to the total Italian raw milk production is about 42%.

The main objective of the study was to assess the Global Warming Potential (GWP) of the total cow milk production in the Lombardy region through a Life Cycle Assessment approach. Moreover an assessment of greenhouse gas emissions of milk production as a function of the altitude zones was performed.

## 3. Material and methods

The quantity and quality of milk produced by the dairy cattle farms located in Lombardy were obtained from the official bulletins of the Italian Breeder's Association [4]. The amount of milk produced by the associated farms was the 88.5% of the total Lombardy production.

The milk production per year was converted as Fat and Protein Corrected Milk (FPCM; 4.0% of fat and 3.3% of protein content), starting from the milk composition obtained from the same database. In order to calculate the total GWP of milk production in Lombardy, different values of GWP (kg CO<sub>2</sub> eq/kg FPCM) from the results of previous studies were used. In these studies GWP of milk production from different type of dairy farms located in Lombardy (intensive plain farms, semi-intensive hill farms and semi-extensive mountain farms) was assessed through a cradle to farm gate LCA starting from survey data.

Detailed information about cropping systems, field operations, fuel consumption, livestock management, feeding rations, housing systems, manure management, feed and other purchased materials were collected. GHG emissions from animals, manure, feed and materials produced at farm and purchased were obtained using the equations suggested by Intergovernmental Panel on Climate Change [5] (Tier 2) and the software Simapro 8.0.3. [6]. The detailed methods applied for LCA, which followed the main guidelines suggested by LEAP (7), were described in a previous study [8].

The total GWP of milk production at farm gate in Lombardy was calculate using the value of 1.47 kg CO<sub>2</sub> eq/kg FPCM, obtained in an LCA study [9] conducted on 102 Lombardy dairy farms. In order to calculate the environmental load of milk produced in the three different altitude zones, three mean values of GWP were used respectively for plain, hill and mountain zones [10; 11; 12]. Scenario analyses were performed, assuming for each altitude zone (mountain, hill, plain) the maximum and the minimum GWP values for milk production, from the worst and the best farm, respectively, obtained in the previous studies.

#### **4. Results**

According to the database of the Italian Breeder's Association, the total milk production of dairy farms from Lombardy in 2014 was 4.10 Mt, with an average content of milk fat and protein of 3.37 and 3.31%, respectively. In general dairy farming systems in Lombardy were characterized by intensive traits. The average farm size was 76 lactating cows, while, from the same database, the average farm size in Italy was 39 lactating cows; in Lombardy 50% of the farms had more than 100 cows while in Italy only 20% of farms had more than 100 cows. In Lombardy the average cow milk production per year in 2014 was 9333 kg (23.1% CV) higher than the italian average production (8838 kg/cow; CV=29.8%).

The total GWP of cow milk production at farm level in Lombardy was 5.83 Mt CO<sub>2</sub> eq. corresponding to 1.27% of the total amount of GWP from anthropic activities at national level and 17% of emissions from agricultural sector. The contribution of milk production from the different Lombardy provinces was strongly different: the most productive was Cremona (27.0% of the total) followed by Brescia (24.6%) and Mantova (19.8%). As a consequence Cremona had also the highest value of GWP (26.8%) followed by Brescia (24.4%) and Mantova (19.8%). The less productive cows were in Sondrio province (6996 kg of milk per lactation) but they had the best milk composition: 4.12% for fat and 3.49% for protein. The principal feeds crop production were maize for silage, winter cereal for silage, grass and lucerne hay in all farms. All farms purchased the main quota of concentrate as maize and soybean meal. The feed- self sufficiency showed different values with the highest percentage in Milano, Sondrio and Mantova province (62.9%) and the lowest percentage in Brescia and Cremona (58.4%).

According to ISTAT, 47% of Lombardy land area is plain, 12% hills and 41% mountains. The contribution of the different altitude zones to total milk production in 2014 was: 92% from the plain, 3.8% from the hills and 4.5% from the mountains (Table 1). Most of the total GWP for milk production came from plain farms. Farms located in the mountains were less efficient than the others and had the higher GWP per kg of FPCM but their total environmental impact contributes just for the 5.78% of the total Lombardy GWP from milk production.

Altitude zones	Heads	Milk yield ton	Milk yield %	Milk fat %	Milk protein %	Fat and protein corrected milk (FPCM) ton	GWP kg CO <sub>2</sub> eq/kg FPCM	Source	GWP tot Mt CO <sub>2</sub> eq/t tot FPCM	GWP contribution % total GWP
Mountains	7.32	183575	4.47	4.12	3.49	188040	1.60	Guerci et al., 2014	0.30	5.78
Hills	4.93	156260	3.81	3.83	3.29	152929	1.16	Bava et al., 2014	0.18	3.41
Plain	87.8	3763109	91.7	3.71	3.31	3635013	1.30	Guerci et al., 2013	4.73	90.8

Table 1: Global Warming Potential of milk production by altitude zones (3800 dairy farms)

As reported in table 2, farm characteristics in different altitude zones showed some differences. “The best farms” in the three zones, that means the farms with the lowest GWP for kg of FPCM, had the highest dairy efficiency (kg FPCM/kg DMI), namely the cows produced more milk per kg of feed ingested, thanks to the higher ingestion of maize silage and concentrate. Stocking density was lower in “the best farms” located in mountain and plain than the others. Feed self-sufficiency was higher in the mountains farms due to the utilization of pasture during the hot season.

Variable		Mountain		Hill		Plain	
		The worst	The best	The worst	The best	The worst	The best
Feed intake	kg of DMI	15.0	19.2	21.2	20.9	20.1	21.0
Dairy efficiency	kg FPCM/kg DMI	0.72	1.20	1.28	1.47	0.92	1.38
Maize silage intake	% DMI	36.3	31.1	33.4	38.1	40.0	43.9
Hay intake	% DMI	43.3	42.6	33.6	25.0	19.0	21.9
Concentrate feed intake	% DMI	13.3	20.8	33.0	37.5	43.8	27.4
Feed self-sufficiency	%	72.4	95.1	68.8	38.4	21.6	85.0
Farm land	ha	10.3	22.8	41.3	30.0	16.5	86.5
Lactating cows	n	30.0	25.0	60.0	120	76.0	165
Stocking density	LU/ha	4.65	2.00	3.39	7.34	7.67	3.33
Milk production	kg FPCM/cow day	9.25	19.2	27.6	31.8	18.7	30.5
Global warming potential	kg CO <sub>2</sub> eq/kg FPCM	2.52	1.24	1.37	0.90	1.96	1.02

Table 2: Farm characteristics of the best and the worst farms in term of Global Warming Potential of milk production by altitude zones

The figure 1 showed the GWP of milk production for altitude zone of the whole Lombardy region calculated using the GWP for 1 kg of FPCM produced by the best and the worst farms of each zones. The variability of GWP results suggests that it is possible to mitigate the environmental impact of milk production with management choices, for example modifying the composition of cows rations in order to increase milk yield. The mitigation effect, using the best performing farms as models instead of the worst, is very huge: 51% for Mountain, 34% for Hill and 48% for Plain.

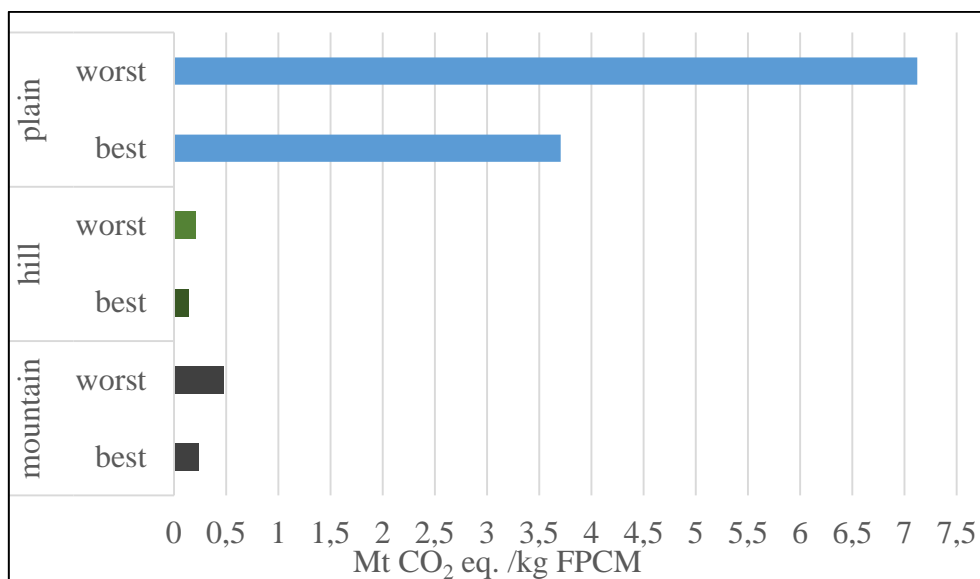

Figure 1: Global Warming Potential of milk production by altitude zones using the data of the best and the worst farms

## 5. Conclusion

In conclusion data indicates that in Lombardy the possible strategies to mitigate greenhouse gas emissions have to be mainly applied to plain farms, because they produced the most amount of milk and they were responsible of the most part of GWP for milk production process at farm. Further investigations would be made in order to identify the best management practices that could mitigate the environmental impact of milk production, as performed by “the best farms” identified in the sample. Moreover it is important to consider that milk production sector determines very low GWP contribution in comparison with other anthropic activities.

## 6. References

- [1] ISPRA, 2014 Italian greenhouse gas inventory 1990-2012. National inventory report 2014. ISPRA Rapporti 198/14.
- [2] Guerci M., Proserpio C., Bava L., Bilato G. 2013. Carbon footprint of “pasteurized liquid milk” life cycle. VII Convegno della rete italiana LCA. Life cycle assessment e ottimizzazione ambientale: esempi applicativi e sviluppi metodologici. Milano 27-28 Giugno 2013. p 51-58.
- [3] Clal, 2015. Accessed January 2015. <http://www.clal.it/>
- [4] AIA (Associazione Italiana Allevatori), 2013. Bollettino dei controlli della produttività del latte. Accessed January 2015. <http://bollettino.aia.it/bollettino/bollettino.htm>
- [5] IPCC (Intergovernmental Panel on Climate Change). 2006. Emissions from livestock and manure management. Chapter 10 and 11. Accessed January 2015. <http://www.ipcc-nggip.iges.or.jp/public/2006gl>
- [6] PRé Consultants. 2014. SimaPro (8.0.3.), LCA software. Amersfoort, the Netherlands. Accessed January 2015. <http://www.pre.nl>.
- [8] LEAP, 2015. Environmental performance of large ruminant supply chains: 2 Guidelines for assessment. Draft for public review. Livestock Environmental Assessment and 3 Performance (LEAP) Partnership. FAO, Rome, Italy
- [9] Sandrucci A., M. Guerci, L. Bava, M. Zucali, A. Tamburini, 2013. Carbon footprint of cow milk production in different farming systems. Ital. J. Anim. Sci., 12 (suppl.1) 61-61.
- [10] Bava L., Zucali M., Tamburini A., Guerci M., Sandrucci A. 2014. Sostenibilità ambientale delle aziende di bovini da latte valutata secondo il metodo Life Cycle Assessment. In Modelli di azienda zootecnica per latte e formaggi d’eccellenza. Quaderni della Ricerca n 163, Regione Lombardia
- [11] Guerci M., Bava L., Zucali M., Sandrucci A., Penati C., Tamburini A. 2013. Effect of farming strategies on environmental impact of intensive dairy farms in Italy. J. Dairy Res. 80 (03):300-308
- [12] Guerci M, Bava L, Zucali M, Tamburini A, Sandrucci A, 2014. Effect of summer grazing on carbon footprint of milk in Italian Alps: A sensitivity approach. J. Clean. Prod., 73:236-244

# Life cycle assessment of sugar production in Hamadan sugar mill

Majid Namdari<sup>1,2</sup>, Shahin Rafiee<sup>1</sup>, Mortaza Aghbashlo<sup>1</sup>, Soleiman Hosseinpour<sup>1</sup>, Bruno Notarnicola<sup>2</sup>,  
Pietro A. Renzulli<sup>2</sup>, Giuseppe Tassielli<sup>2</sup>

<sup>1</sup>Faculty of Agricultural Engineering & Technology, University of Tehran, Iran

<sup>2</sup>Ionian Department of Law, Economics and Environment, University of Bari, Italy

E-mail contact: majid.namdari@uniba.it

## 1. Abstract

*Iranian sugar is one of the most important commodities of the national agro based industries. However Iranian sugar mills are old and technologically outdated and are therefore responsible for a large share of the environmental burden of food production. Sugar mills use various inputs during processing which include chemicals, limestone, electricity, water, natural gas and are also responsible for a series of the burdening emissions. The present study stems from a project whose aim is that of optimising Iranian sugar production. Specifically for the work described here, Life Cycle Assessment (LCA) was applied to the Hamadan sugar mill. For cultivation phase data from 88 sugar beet farms were collected. This information was then used, together with the inventory data from the sugar mill, to calculate the environmental impact of sugar production in terms of impact categories. The preliminary LCA results indicate that the role of electricity and natural gas are high in impact categories due to agricultural and industrial phases, respectively.*

## 2. Introduction

Sugar beet is considered a valuable crop, since sugar is an essential product for human life and hence highly demanded in the world market. The food industry, being one of the world's largest industrial sectors, consumes large amounts of materials and energy which result in contributions to a wide range of environmental impacts. Iranian sugar mills are old and technologically outdated and therefore heavily contribute to such environmental burdens of food production.

Life cycle assessment (LCA) is an internationally recognised environmental accounting tool which offers a standardised framework and methodology for quantifying the environmental impacts of a product or a production system throughout its life cycle. In this work, LCA was used to assess the environmental impact of sugar production in the Iranian Hamadan province with a special focus on the agricultural phase.

## 2. Materials and Methods

### 2.1 Data sources, functional unit and system boundaries

Data for the quantities of inputs and outputs used in sugar production were sourced from face to face interviews of 88 sugar beet growers and industry statistics regarding Hamadan sugar mills, during the 2013 cropping year. The functional unit (FU) chosen was 1 ton of white sugar. Four stages of the life cycle of sugar, i.e. cultivation, production, transportation and processing were considered in this study. The systems boundary covers all emissions from raw material used for sugar beet cultivation to the milling process (cradle-to-gate).

## 2.2 Estimate of emissions

In the agricultural phase, emissions (to air, water and soil) were estimated from the production and application of fertilizers, herbicides, pesticides, fungicides, human labour, electricity, and fossil fuels used during cultivation practices. N<sub>2</sub>O emissions (direct and indirect) from the amount of N applied were estimated. CO<sub>2</sub> emissions from urea use were accounted for by using the IPCC emission factor. In terms of fossil fuel use, diesel used in agricultural machinery and sugar beet transportation from sugar beet farm to sugar mill were considered. The emissions were estimated starting from the amount of fuels used and by applying the emission factors given by IPCC [1]. The total amount of active ingredients of chemicals (herbicides, pesticides and fungicides) is emitted in the agricultural soil compartment [1].

In the industrial phase: emissions from limestone, sulphur, natural gas, electricity, human labor, fossil fuel (mazut) utilization and wastewater treatment plant of sugar mill factories were estimated. The data were collected by using questionnaires and recorded documents from the sugar mill. The emissions were estimated using an emission factor from IPCC [1].

## 2.3 Impact assessment

Life cycle impact assessment (LCIA) results were generated using the CML-IA baseline model. Classification/characterization was used according to the ISO 14040:2006 [2].

## 3. Results, discussion and conclusions

Information on farm operations and energy utilization from 88 sugar beet farms shows a wide variability. The main inputs of the LCI for sugar beet grown in Iran for one hectare of sugar beet are shown in Table 1.

In this study, emissions from both production and utilization of all inputs were estimated. Emissions from chemical fertilizations were calculated separately from the production and utilization phases. Based on the amount of N inputs and emission factors from IPCC, the N<sub>2</sub>O emission from N fertilizers (urea and di-ammonium phosphate) were estimated on average as 4.54 kg N<sub>2</sub>O ha<sup>-1</sup>y. In the same way, the N<sub>2</sub>O emission from manure and residue of sugar beet (leaves) were estimated as 2.23 and 2.20 kg N<sub>2</sub>O ha<sup>-1</sup>y, respectively. Application of N fertilizer can result in both direct and indirect emissions of N<sub>2</sub>O from soil. In this study, direct emissions were estimated from N application through synthetic fertilizer, manure application and crop residues. Table 1 also shows that the N<sub>2</sub>O indirect emissions were estimated to be 2.15 kg N<sub>2</sub>O ha<sup>-1</sup>y. In the Table 1 also illustrates other emissions to air, such as ammonia (NH<sub>3</sub>), CO<sub>2</sub> emissions from urea, NO<sub>x</sub> and diesel combustion emissions. The NO<sub>x</sub> emissions are estimated from the emission of N<sub>2</sub>O [1]. The results show that the average of estimated nitrate leaching per hectare of sugar beet produced in Hamadan was 238.79, 132.36 and 138.18 kg NO<sub>3</sub> from fertilizers, manure and residue, respectively. This means that a total of 5.11 kg of NO<sub>3</sub> leaches per ton of sugar beet. Soltani et al. (2010) [3] reported 9.72 kg NO<sub>3</sub> per ton of wheat in Gorgan, Iran, but Bazrgar et al. (2011) [4] reported a very low value for sugar beet production in Iran (0.16 kg NO<sub>3</sub> per ton of sugar beet).

Input/Output (unit)	Average (unit/ha)	SD	Input/Output (unit)	Average (unit/ha)	SD
<b>Products:</b>			<b>Output</b>		
Sugar beet (kg)	53466.10	19289.31	<b>Emission to Air (kg)</b>		
Fresh leaves (kg)	26190.64	9448.97	NH <sub>3</sub> from N (fertilizers)	63.63	74.76
<b>Inputs:</b>			CO <sub>2</sub>	711.54	380.54
Chemical Fertilizers (kg)			NO <sub>x</sub>	1.85	1.48
Urea as N	179.73	87.12	N <sub>2</sub> O direct	6.64	5.01
diammonium phosphate as N	38.49	18.92	N <sub>2</sub> O indirect	2.15	2.06
Potassium Sulfate as K <sub>2</sub> O	69.60	34.63	Total N <sub>2</sub> O	8.79	7.06
Transport of fertilizers (tkm)	160.68	85.88	<b>Emission to Water (kg)</b>		
Farmyard manure (kg)	4408.14	12729.76	NO <sub>3</sub>	510.33	420.70
Chemicals (kg)			P	2.76	2.13
Herbicide	2.23	3.00	<b>Emission to Soil (kg)</b>		
Pesticide	2.15	1.88	Trifluralin	1.05	1.43
Fungicide	0.57	1.32	Diazinon	1.29	1.13
Transport of chemicals (tkm)	0.74	0.60	Tridemorph	0.43	0.99
Diesel fuel in farm (L)	116.66	70.17			
Lubricant Oil (L)	29.55	50.19			
Electricity (kWh)	12537.07	8558.83			
Water for irrigation (m <sup>3</sup> )	8859.61	5475.10			
Machinery (kg)	13.27	5.72			
Sugar beet seed (kg)	1.96	0.39			
Micro fertilizer (kg)	7.24	7.49			
Transp. micro fertilizer(tkm)	1.09	1.12			

Table 1: Inventory of sugar beet production (referred to 1 ha)

Input/Products	Unit	Amount (Unit/t sugar)	Output	Unit	Amount (Unit/t sugar)
<b>Products</b>			<b>Outputs</b>		
White Sugar	kg	1000.00	Wastewater	m <sup>3</sup>	12.60
Molasses	kg	264.28	Lime Mud	m <sup>3</sup>	0.41
Pulp	kg	441.80	<b>Emission to air</b>		
<b>Inputs</b>			CO <sub>2</sub> (from CaCO <sub>3</sub> )	kg	165.18
Transport of sugar beet	tkm	35.72	Emissions from Mazut combustion	MJ	128.12
Sugar beet	kg	6672.84	Emissions from Natural Gas combustion	MJ	25193.73
Limestone	kg	375.41	CO <sub>2</sub> from human labor	kg	13.40
Electricity	kWh	113	<b>Emission to water</b>		
Natural Gas	m <sup>3</sup>	719.82	COD (from wastewater)	kg	22.32
Mazut	kg	31.25	BOD <sub>5</sub> (from wastewater)	kg	16.33
Water	m <sup>3</sup>	22.53			
Labor	h	19.19			
Sulfur	kg	0.67			
Sulfuric acid (H <sub>2</sub> SO <sub>4</sub> )	kg	0.20			

Table 2: Inventory of the industrial phase (transport and milling stages) referred to the FU (1 t)

The inventory of the industrial phase is shown in Table 2. Emissions from transportation of sugar beet to sugar mill are also shown in Table 2.

Table 3 shows the characterization results of the agricultural and industrial phases in sugar production per impact category. This table points out that global warming of agricultural and industrial phases are respectively  $1.67 \cdot 10^3$  kgCO<sub>2</sub>eq and  $3.54 \cdot 10^3$  kgCO<sub>2</sub>eq per ton of sugar.



Results showed that electricity used in irrigation system had the highest impact in all categories (except for eutrophication). Water located at fairly deep soil sub levels and use of ancient methods for irrigation are reported as the reasons for a high consumption of electrical energy in the studied region; this leads to higher consumption of both water and energy [5]. Soil water monitoring can allow more precise irrigation scheduling to improve the efficiency of beet production thus reducing the associated environmental impacts. The impact on acidification and eutrophication is mainly due to air emissions of nitrogen oxides and ammonia and nitrate leaching respectively.

In the industrial phase, natural gas has the highest impact. In conclusion, the adoption of new methods for beet sugar processing and machinery renewal in the mills are needed to improve energy efficiency and to reduce emissions of environmental pollutants.

Impact category	Unit	Agricultural phase	Industrial phase	Total
Abiotic depletion	kg Sb eq	$2.04 \times 10^{-3}$	$8.59 \times 10^{-5}$	$2.13 \times 10^{-3}$
Abiotic depletion (fossil fuel)	MJ	$1.93 \times 10^4$	$2.47 \times 10^4$	$4.40 \times 10^4$
Global warming (GWP100a)	kgCO <sub>2</sub> eq	$1.67 \times 10^3$	$1.54 \times 10^3$	$3.21 \times 10^3$
Ozone layer depletion (ODP)	kgCFC-11 eq	$4.46 \times 10^{-5}$	$2.47 \times 10^{-5}$	$6.93 \times 10^{-5}$
Human toxicity	kg 1,4-DB eq	203.64	107.03	$3.11 \times 10^2$
Fresh water aquatic	kg 1,4-DB eq	256.11	33.22	$2.89 \times 10^2$
Marine aquatic ecotoxicity	kg 1,4-DB eq	$2.94 \times 10^5$	$1.30 \times 10^5$	$4.24 \times 10^5$
Terrestrial ecotoxicity	kg 1,4-DB eq	9.28	0.40	9.68
Photochemical oxidation	kg C <sub>2</sub> H <sub>4</sub> eq	0.29	0.22	$5.08 \times 10^{-1}$
Acidification	kg SO <sub>2</sub> eq	17.07	4.29	21.36
eutrophication	kg PO <sub>4</sub> eq	9.36	0.43	9.79

Table 3: Characterization results of sugar beet and sugar production (referred to 1 ton sugar)

#### 4. References

- [1] IPCC, 'Prepared by the National Greenhouse Gas Inventories Programme'. In: H.S. Eggleston, L. Buendia, K. Miwa, T. Ngara and K. Tanabe (eds.) IPCC guidelines for national greenhouse gas inventories. IGES Ed., Kanagawa, Japan. 2006.
- [2] International Organization for Standardization (ISO), Environmental Management Life Cycle Assessment Principles and Framework ISO 14040. 2006.
- [3] Soltani, A., Rajabi, M.H., Zeinali, E., Soltani, E., 'Evaluation of environmental impact of crop production using LCA: wheat in Gorgan, Electronic', J. Crop Prod., 3 (2010) 201-218.
- [4] Bazrgar, A.B., Soltani, A., Koocheki, A., Zeinali, E. and Ghaemi, A., 'Environmental emissions profile of different sugar beet cropping systems in East of Iran'. Afric J of Agri Res. 6(29) (2011) 6246-6255.
- [5] Mobtaker, H.G., Akram, A., Keyhani, A. and Mohammadi A., 'Energy consumption in alfalfa production: A comparison between two irrigation systems in Iran', Afric J of Plant Sci. 5(1) (2011) 47-51.

# Sustainability in breeding farms: the case of the Maremmana beef

Elena, Neri<sup>1</sup>; Riccardo Maria, Pulselli<sup>2</sup>; Michela, Marchi<sup>3</sup>; Simone, Bastianoni<sup>4</sup>

<sup>1,2</sup>INDACO<sub>2</sub> Srl spin-off, University of Siena, Italy

<sup>3,4</sup> Ecodynamics Group, DSFTA, University of Siena, Italy

E-mail contact: [elena.neri@indaco2.it](mailto:elena.neri@indaco2.it)

## 1. Abstract

*The Slow Food Foundation has recently launched the “narrative label” project aimed to inform consumers on lifecycle of products. Based on a pilot studies on meat supply chains, labels were provided including both qualitative and quantitative information. LCA has been applied to a wild breeding system of Maremmana cattle, a Slow Food Presidia in Tuscany (Italy), from feed production to the butcher shop. Enteric fermentations, manure management and ecosystem uptake within the farm were also evaluated by specific models. Results show that the Carbon Footprint is 16.67 kg CO<sub>2</sub>-eq per kg (carcass weight), 89% of which is due to enteric fermentation and manure management. Possible best practices were identified in order to further minimize impacts. Emissions from the livestock were found to be completely “compensated”, thanks to the CO<sub>2</sub> direct absorption by ecosystems within the farm.*

## 2. Introduction

Livestock constitutes the 9% of global greenhouse gases (GHG) emission (3057 Mton CO<sub>2</sub>-eq per year; [1]), 54% of which are due to bovine livestock. Information on product supply chains is therefore fundamental to raise consumer awareness on the environmental implications of their food choices. This study is the first part of a pilot project, promoted by the Slow Food Foundation, aimed at providing quantitative information on lifecycle of products in order to support their qualitative description as part of a “narrative label” dedicated to Slow Food Presidia. The Maremmana Presidium in Tuscany (Italy) was selected as representative, since breeding farms follow “natural principles” for the growth and care of their animals [2].

The LCA has taken into account the whole production chain, including enteric fermentations (hereafter e.f.), manure management (hereafter m.m.) and farm ecosystem uptakes.

## 3. Materials and methods: case study, LCA and Uptake modeling

LCA has been applied to a representative breeding-farm of Maremmana cattle, an autochthonous race in the Maremma area, the southern part of Tuscany (Italy). The Maremmana has large lyre-shape horns and a grayish coat. It is frugal, adapts well to difficult environments and cannot be kept indoors, but must roam freely. It is an extraordinarily robust native breed and the fact that the cattle range in the wild contributes to their well-being and to makes their meat especially flavorful and wholesome [2].

The selected farm is 183 ha large (50% forest and 40% arable/grazing land). Livestock includes 32 cows, 1 bull and about 30 calves per year. Animals freely graze in forest and grazing lands. Calves are fattened in cattle-shed only during the last two months before slaughtering, till about 480 kg weight, 18 months old (65% half carcass yield). Feed is composed by hay, barley (auto-produced within the farm) and grass. Mother cows only eat hay and grass. Beef meat is transformed and sold locally. System boundaries include the whole supply chain, from cradle to gate. Packaging and distribution have no relevance (no packaging and locally sold).

The life cycle is divided into 3 phases: (#1) feed production within the farm, (#2) livestock management (from gestation to fattening, including the mother cow contribution and cattleshed consumptions) and (#3) slaughtering/meat processing. Mother cow impacts are allocated to calf (each cow calves one calf only) including feed, e.f. and m.m. during the gestation (9 months) and nourishing/weaning phase (6 months). Allocation, where necessary, is performed per mass. All data are collected by direct interview with the farmer. The Functional Unit (FU) is 1 kg carcass weight. LCA was performed with the SimaPro 7.3.3 software [3], selecting the method IPCC 2007 (100 yrs). E. f. and m.m. emissions are calculated by quantifying local specific emission factors, based on animal diet and collection/storage of manure from grazing or enclosed confinement facility, depending on the livestock life-time. Tier 2 was applied, according to 2006 IPCC Guidelines [4], focusing on a medium level of accuracy for the selection of calculation parameters. The uptakes by oak high forest and olive grove, within the farm, are estimated with equations proposed by 2006 IPCC Guidelines [4], in order to quantify the annual increase in carbon stocks. The carbon uptake due to herbaceous plants are calculated by a dynamic model elaborated with the STELLA 8.1.4 software [5]. The “farm GHG balance” is quantified subtracting the uptakes to the total Carbon Footprint (hereafter CF).

#### 4. Results and discussion

Outcomes show that the Carbon Footprint is 16.67 kg CO<sub>2</sub>-eq per 1 kg of carcass weight. The 89% of total impacts is associated to phase#2, 10% to phase#1 and about 1% to phase#3 (fig.1). In particular, impacts of phase#2 are due to e.f. (54% on total CF), m.m. (34% on total CF), materials handling (i.e. diesel consumption for haystacks transport within the farm and cattleshed; 1% on total CF) and electricity consumption (<1% on total CF). Phase#1 impacts derive from diesel consumption by machineries for hay (7% on total CF), barley (3.2% on total CF) and straw (0.2% on total CF) production, and phase#3 from transports of calves and electricity/water use in slaughtering house/ butcher shop (both <1%).

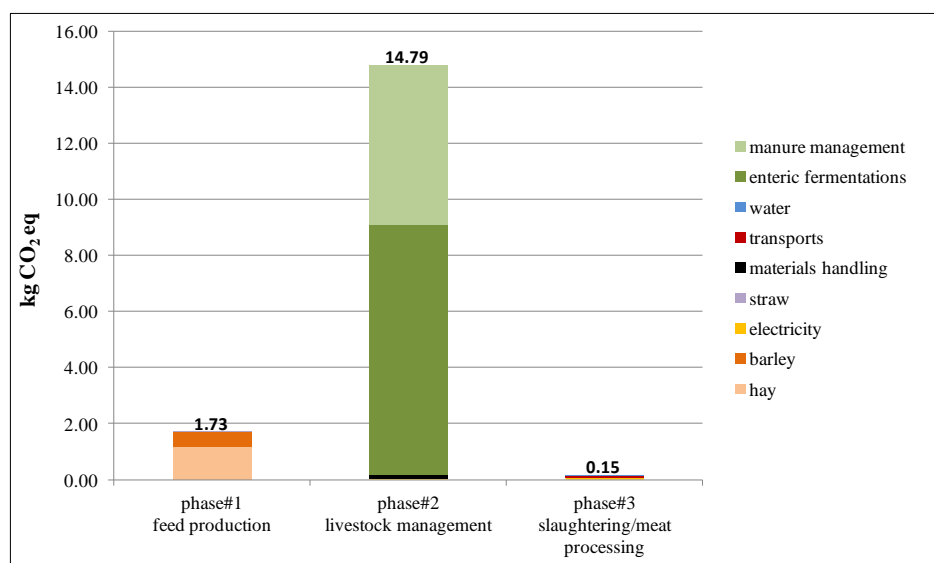

Figure 1: Carbon Footprint per phases of the calf lifecycle (kg CO<sub>2</sub>-eq per FU=1 kg half carcass)

Impacts for farm (and butcher) management (2.06 kg CO<sub>2</sub>-eq per UF, mainly due to diesel consumption), including phase#1, phase#3, electricity and material handling in phase #2, are very low in respect to e.f. (8.8 kg CO<sub>2</sub>-eq per UF) and m.m. (5.8 kg CO<sub>2</sub>-eq per UF), (respectively 12%, 54% and 34% on total CF).

Even though it is difficult to compare results with literature values in this sector [6], the CF of Maremmana resulted about 20% lower per FU (compared to [7, 8, 9, 10]), mainly because of good practices (such as: feed auto-production without chemicals; use of livestock manure as fertilizer; use of lake water for livestock; rearing system in a semi-natural way; low electricity use). The mother cow contribution to total impacts is about 43% in respect to 57% related to calf contribution. The high relevance of e.f. is in line with other studies [11, 12], even though the Maremmana breeding has higher values for e.f. and m.m. per FU, due to the long lasting growing time to reach the right weight to be slaughtered (Maremmana: 18-20 months versus conventional: max 15 months [7]). Among possible solutions to further decrease impacts, reducing diesel consumption with machinery replacement, is the most recommended.

The CF of total livestock (taking into account impacts for adults and calf live weight in an average year, excluding the product transformation) is 179809 kg CO<sub>2</sub> -eq per year. The total CO<sub>2</sub> uptake by farm forestland, grassland and cropland is 748000 kg CO<sub>2</sub> per year. Assuming that the CF value was kg CO<sub>2</sub> and not kg CO<sub>2</sub>-eq, the Maremmana farm Offset would be

-568191 kg CO<sub>2</sub>. Emissions from the total livestock can be considered as completely “compensated” by CO<sub>2</sub> uptake by farm ecosystems.

## 5. Conclusion

Outcomes from LCA of the Maremmana breeding farm showed lower impacts (limited to the CF impact category [13]) compared to other “conventional” breeding systems. This allows for the following observations:

- based on LCA, breeding farmers can be informed on the environmental implications of their production. Best practices can be implemented to produce beef meat with less impact and in a more sustainable way. The Maremmana is an example of good farming as it allows for high quality meat products with lower impacts;
- consumers can be informed on impacts of breeding farms and addressed first to decrease their meat consumption and then to choose high quality meat products with lower environmental impacts. This is the aim of the Slow Food “narrative label” project.

Acknowledgements: authors thank the Slow Food team, particularly Raffaella Ponzio and Jacopo Ghione, and the Maremmana breeding farm for their precious collaboration.

## 6. References

- [1] Caro, D., Davis, S.J., Bastianoni, S. and Caldeira, K., 'Global and regional trends in greenhouse gas emissions from livestock', *Clim. Change* 126 (2014), 203-216.
- [2] <http://www.fondazioneSlowFood.com/en/slow-food-presidia/maremma-cattle/> Accessed June 2015
- [3] PRé Consultants, 'SimaPro 7.3, LCA software. Amersfoort. The Netherlands', (2012), [www.pre.nl/simapro/default](http://www.pre.nl/simapro/default). Accessed June 2015.
- [4] IPCC, '2006 Guidelines for National Greenhouse Gas Inventories', (IGES, Japan, 2006).
- [5] STELLA, 'STELLA and iThink Technical Documentation', Isee systems (2005).
- [6] Roma, R., Corrado, S., De Boni, A., Bonaventura-Forleo, M., Fantin, V., Moretti, M., Palmieri, N., Vitali, A. and De Camillis, C., 'Life cycle assessment in the livestock and derived edible product sector', in 'Life Cycle Assessment in the Agri-food Sector: . Case studies, methodological issues and best practices', (Springer, 2015).
- [7] Coop Italia, 'EPD Coop beef meat', S-P-00495 (2013) available at <http://www.environdec.com/en/Detail/epd495#.VXq6ZLIH59A>. Accessed June 2015.
- [8] Browne, N.A., Eckard, R.J., Behrendt, R., Kingwell, R.S., 'A comparative analysis of on-farm greenhouse gas emissions from agricultural enterprises in south eastern Australia', *An. Feed Sc. and Techn.*, 166–167(2011) 641-652.
- [9] Beauchemin, K.A., Janzen, H., Little, S.M., McAllister, T.A., and McGinn, S.M., 'Life cycle assessment of greenhouse gas emissions from beef production in western Canada: A case study', *Agric. Syst.* 103(6) (2010) 371–379.
- [10] Nguyen, T.T.H., van der Werf, H.M.G., Eugène, M., Veysset, P., Devun, J., Chesneau, G. and Doreau, M., 'Effects of type of ration and allocation methods on the environmental impacts of beef-production systems', *Liv. Sci.* 145 (1) (2012) 239–251.
- [11] Nijdam, D., Rood, T., and Westhoek, H. 'The price of protein: Review of land use and carbon footprints from life cycle assessments of animal food products and their substitutes'. *Food Policy*, 37(6) (2012) 760–770.
- [12] Veysset, P., Lherm, M. and Bebin, D., 'Energy consumption, greenhouse gas emissions and economic performance assessments in French Charolais suckler cattle farms: model-based analysis and forecasts', *Agric. Syst.* 103 (2010) 41–50.
- [13] International Standard Organisation (ISO), 'ISO 14067 Greenhouses gases—carbon foot-print of products-requirements and guidelines for quantification and communication', (Geneva, 2013).

# Carbon Footprint of tropical Amazon fruit jam from agroforestry

Guido Scaccabarozzi<sup>1</sup>, Francesca Allievi<sup>1</sup>, Stefano Parmeggiani<sup>1</sup>, Claudia Camera<sup>1</sup>, Michel Saini<sup>2</sup>, Tatiana Espinosa<sup>2</sup>, Rocio Espinosa<sup>2</sup> and Giovanni Dotelli<sup>3</sup>

<sup>1</sup>ArBio Italia, via Montello 9, 23889 Santa Maria Hoè (LC)

<sup>2</sup>ArBio, Jiron Libertad 646, Puerto Maldonado, Perú

<sup>3</sup>Politecnico di Milano, Dip. Chimica, Materiali e Ingegneria Chimica "G.Natta", piazza L. da Vinci 32, 20133 Milano  
E-mail contact: arbioitalia@gmail.com

## 1. Abstract

A cradle-to-grave Carbon Footprint of a jam made with tropical Amazon fruit is presented. The analysis is grouped into three general processes: upstream, core and downstream. In this preliminary study the global warming indicator is considered. Most of the data was gathered on the field by members of ArBio and can be classified as primary data. The cultivation and the jam manufacturing are done in Madre de Dios (Perù) and the product is imported to Italy by Equo Mercato in its final packaging. The present analysis is limited to the Italian market excluding Sicily and Sardinia.

## 2. Introduction

The Amazon rainforest is one of the most endangered ecosystems on Earth; especially during the last decades, deforestation due to intensive practices such as cattle ranching and monoculture cultivations, has become evident along the Brazilian layout of the Inter-Oceanic highway. After the finalization of the Peruvian part of the highway, areas of the Amazon forest crossed by this infrastructure might undergo damages similar to those that have taken place on the Brazilian side.

Agroforestry [1], a relatively new word that refers to growing trees together with agricultural crops and animals, is a possible solution for restoring degraded and eroded landscapes. Even though the concept is new, humans have practiced agroforestry for thousands of years, providing food, medicine, and materials to their communities in a sustainable way. Furthermore, agroforestry also provides highly valuable ecosystem services, such as conservation of soil and water and biodiversity, in addition to other human benefits such as landscape beauty and wellness. Agroforestry should be considered as an intermediate step towards analog forestry [2], a complex and holistic form of agroforestry aiming at maintaining a functioning tree-dominated ecosystem while providing marketable products that can sustain rural communities, both socially and economically.

ArBio [3], an association born in 2010 in Puerto Maldonado (the capital city of Madre de Dios, the southern Amazon region of Peru), works on a 916 hectares (equivalent to 9,16 km<sup>2</sup> or 2290 acres) area of Amazon forest, obtained through a concession contract granted by the Peruvian government, in association with a neighbouring land owner who also received a land grant of 7.24 km<sup>2</sup> (or 1810 acres). Both areas are involved in a pilot project, which aims at demonstrating that coexistence is possible between the forest ecosystem, local populations and the Inter-Oceanic highway. This idea reflects exactly the meaning of ArBio: Association for the Resilience of the Forest to the Inter-Oceanic (*Asociación para la Resiliencia del Bosque frente a la Inter-Oceánica*). Through agroforestry, and subsequently analog forestry, ArBio works for the sustainable development of this region, trying to avoid that the Inter-Oceanic highway entails the destruction of the forest and the loss of biodiversity.

Among the marketable products already commercialised by ArBio, there is a jam obtained by the Cupuaçu fruit (*Theobroma grandiflorum*) [4], a tropical rainforest tree from the same family as cacao. Cupuaçu is quite common throughout the Amazon basin and widely cultivated in the jungles of Colombia, Bolivia and Peru and in the north of Brazil. The jam is obtained by the white pulp of Cupuaçu, which has a unique fragrance (a mix of chocolate and pineapple), and for this reason has the potential to become well recognized among tropical fruit-trees. Moreover, expansion of its cultivation to the Amazon does not present any serious limitations, because the climate is suitable and land is available. Also, this species can grow under the shade of the forest canopy.

In the present work, a Carbon Footprint Analysis (CFA) study is performed of the Cupuaçu jam supply chain, from the agroforestry practice realized by ArBio and its local partners in the Madre de Dios (Peru), to the commercialization in Italy by ArBio Italia through Equo Mercato [5] in Cantù (Northern Italy).

### **3. System Description**

General boundaries of the system are sketched in Figure 1. The perspective adopted is from-cradle-to-gate and the division of phases into three macro-processes, i.e. upstream, core and downstream, was done following the Product Category Rule published by Environdec [6]. The upstream processes comprise the fruit cultivation, transportation from field to plant, ingredients production, and secondary and tertiary packaging production. Operators carry out in-field operations without using any machine. Primary packaging production, i.e. glass pot and caps, have been included in the core process together with product manufacturing, thermal treatment and packaging processes. Cultivation and jam manufacturing are located in the Madre de Dios region in Peru. The downstream processes are essentially transportation to Italy (Puerto Maldonado – Callao Harbour - Genova harbour – ArBio warehouse in Cantù) and delivery to sale points distributed over the Italian peninsula. For the present case, Sicilia and Sardinia sale points were not considered. End-of-life scenarios were created in accordance with recycling to landfill ratios published in the Ispra report [7] as for glass pots and metal caps.

The functional unit adopted is 1 kg of product including packaging, but packaging weight is not included in the 1 kg. The cupuaçu jam is sold in pots containing 212 g of product, as detailed in Table 1. Cupuaçu jam has no additives or preservatives; the only ingredients are fruit pulp and sugar cane. The average pulp-to-fruit ratio is 0.25 and the cultivation yield is about 2000 kg of fruit per hectare per year (see Table 2).

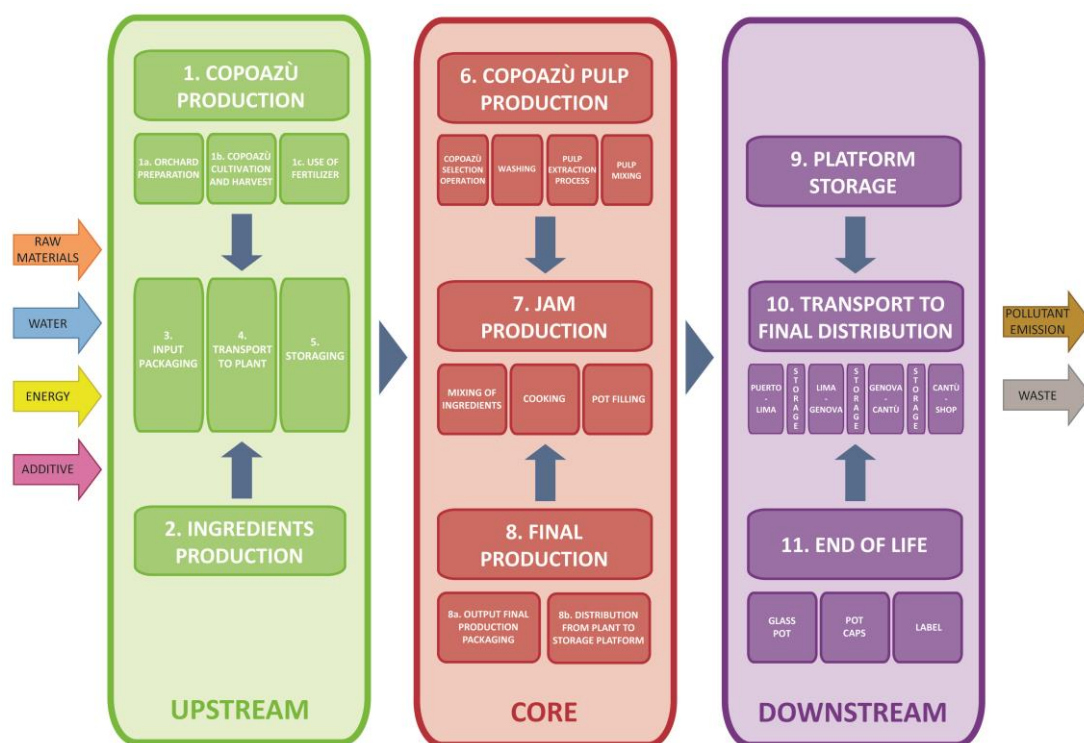

Figure 1 : Flowchart highlighting boundaries of the system

Product	Pots Content	Functional Unit	Pots Number per FU
Cupuaçu Jam (Theobroma Grandiflorum)	212 g	1 kg	4.72

Table 1: Functional unit and reference flow data

Cupuaçu Fruit	Cupuaçu Pulp	Sugar Cane	Cupuaçu Jam
2.28 kg	0.57 kg	0.43 kg	1 kg

Table 2: Cupuaçu jam composition

Upstream	Core	Downstream	Total	UM
0.174	2.120	1.251	3.545	kg CO2 eq
4.91%	59.80%	35.29%	100.00%	%

Table 3: Carbon Footprint of Cupuaçu jam stages



Core			Total	UM
Pulp production	Jam production	Final production		
0.625	0.364	1.131	2,120	kg CO2 eq
29.48%	17.17%	53.35%	100.00%	%

Table 4: Carbon Footprint of Cupuaçu jam – Core stage subdivided according to flowchart scheme in Figure 1

#### 4. Conclusion

Preliminary results of the carbon footprint of Cupuaçu jam are reported in table 3. Agroforestry practices, which constitute the upstream process, have very low impacts with respect to other phases. It is worth noting that the high carbon content in the core process is mainly due to the primary packaging production. As expected, downstream processes are highly affecting because of the long distance necessary for the transportation of the final product to Italy. These conclusions are based on a preliminary analysis that takes into account only one impact indicator and neglects other categories, which, instead, could have important positive benefits deriving from agroforestry practices, such as biodiversity preservation, water saving and social advantages to local populations. These issues will be addressed in future works.

#### 5. References

- [1] [www.worldagroforestry.org](http://www.worldagroforestry.org)
- [2] Bekins Faries, M. 'Analog Forestry: A practitioner's guide', International Analog Forestry Network, Costa Rica, January 2012. [www.analogforestry.org](http://www.analogforestry.org)
- [3] [www.arbioperu.org](http://www.arbioperu.org)
- [4] 'Amazonia, guía ilustrada de flora y fauna', Programa de Cooperación Hispano Peruano – Proyecto Araucaria XXI Nauta. Ministerio del Ambiente – Enlace Regional Loreto. Agencia Española de Cooperación Internacional para el Desarrollo – Oficina Técnica de Cooperación.
- [5] [www.equomercato.it](http://www.equomercato.it)
- [6] 'UN CPC 21494 - Product Category Rules - jam, fruit jellies, marmalades, fruit or nut puree and fruit or nut paste' 2011:19 version 1.02 © 2014 The International EPD® System
- [7] 'Rapporto rifiuti urbani, dati di sintesi'. ISPRA 202/2014  
[http://www.isprambiente.gov.it/files/pubblicazioni/rapporti/RapportoRifiutiUrbani2014\\_web.pdf](http://www.isprambiente.gov.it/files/pubblicazioni/rapporti/RapportoRifiutiUrbani2014_web.pdf)

# Life-cycle assessment of chestnut produced in the north of Portugal

*Diana Rosa, Filipa Figueiredo, Érica Castanheira and Fausto Freire*

*ADAI-LAETA, Department of Mechanical Engineering, University of Coimbra*

*Polo II Campus, R. Luís Reis Santos, 3030-788 Coimbra, Portugal*

[diana.rosa@dem.uc.pt](mailto:diana.rosa@dem.uc.pt), [filipa.figueiredo@dem.uc.pt](mailto:filipa.figueiredo@dem.uc.pt), [erica@dem.uc.pt](mailto:erica@dem.uc.pt), [fausto.freire@dem.uc.pt](mailto:fausto.freire@dem.uc.pt)

## 1. Abstract

This article compares the environmental impacts of fresh and frozen chestnut produced in Portugal (for exports and national consumption). A life-cycle model and inventory was implemented for chestnut cultivation, processing and packaging, distribution, retail and final preparation for consumption. Climate change (CC), terrestrial acidification (TA), freshwater eutrophication (FEW) and marine eutrophication (ME) were analyzed. The cultivation stage presented the most significant contribution to the environmental impacts of both fresh and frozen chestnut (from 43% in CC to 98% in ME). The results showed the importance of improving resource management practices at the cultivation stage, namely an efficient use of fertilizers and fossil fuels, together with increasing chestnut yields, reducing the environmental impacts of both fresh and frozen chestnut.

## 2. Introduction

Portugal was the third largest producer of chestnut in Europe and the seventh worldwide in 2013, with an annual production of 24.7 thousand tons, and an orchard area of 35 thousand hectares [1, 2]. The north of the country represented 84% of production and 88% of the chestnut orchard area [2]. Roughly 70-75% of Portuguese chestnuts are intended for exports, essentially to Italy, Spain and traditional markets of Portuguese emigration (France and Brazil) [3].

The Life-Cycle Assessment (LCA) methodology has been applied to multiple agricultural products; however, as far as the authors are aware, only a few LCA studies have been done for chestnuts [4, 5, 6].

## 3. Life-cycle model and inventory

The functional unit chosen for this study was 1 kg of chestnut kernel at consumer (including storage and final preparation at household). A cradle-to-plate analysis was performed. The system boundaries are presented in Figure 1. Two producers from northern Portugal were analysed: P1 (881 kg ha<sup>-1</sup>, 92 ha, year 2011) and P2 (1048 kg ha<sup>-1</sup>, 7 ha, 2010 to 2012). The main agricultural processes were soil management, fertilization, pruning, pesticide treatments and harvesting.

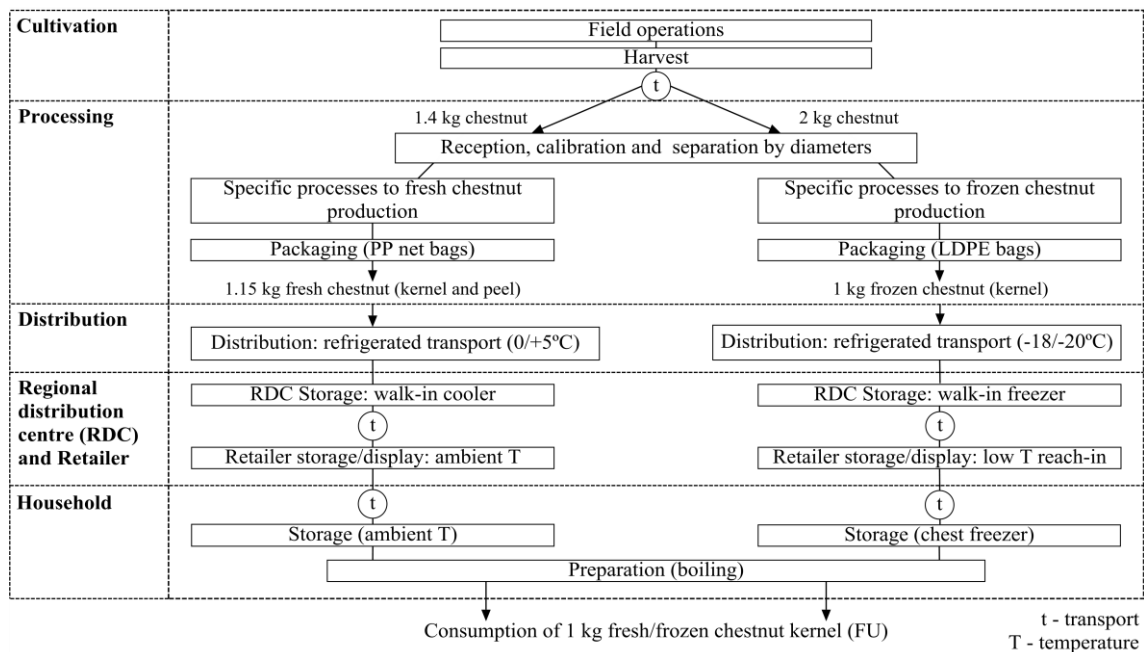

Figure 1: Fresh and frozen chestnut production chain.

Fresh and frozen processing lines were studied. Data was collected from an industrial unit in Portugal. Processing starts with reception, calibration and separation of chestnuts by size. Frozen chestnuts were peeled, sorted, frozen and packed; while fresh chestnuts were sterilized, sorted and packed. Two kg of harvested chestnut were required to produce 1 kg of frozen chestnut (kernel) while 1.4 kg of harvested chestnut were required to produce 1.15 kg of fresh chestnut (kernel and peel). Frozen chestnut was packed in 1 kg LDPE (low density polyethylene) bags and fresh in PP (polypropylene) mesh bags.

It was assumed that the main national distribution (refrigerated) was to Lisbon (truck) and exports were to France, Italy (truck) and Brazil (ship). Transport from the factory to a distribution center (RDC) and to the supermarket was included, as well as energy requirements with refrigeration. As for the household stage, consumer transport from the supermarket to the household, energy consumption with storage and cooking were considered. Secondary data was also collected or calculated, namely emissions from fertilization [7, 8], ancillary material and energy production [9, 10], agricultural operations [11], combustion of propane [12], production of packaging materials [13, 14] and transportation [15].

#### 4. Results and discussion

Climate change (CC), terrestrial acidification (TA), freshwater eutrophication (FEW) and marine eutrophication (ME) were analysed (ReCiPe V1.07/Midpoint-H method) as these are typical impact categories in fruit LCA [16]. The cultivation stage presented the most significant contribution for the environmental impacts of both fresh and frozen chestnut (from 43% in CC to 98% in ME). Cultivation impacts derived mostly from diesel requirements (41% for P1) and fertilizer use (58% for P2). Frozen chestnut presented higher environmental impacts than fresh, in all impact categories (from 24% for TA to 36% in CC), mainly due to higher losses of frozen chestnut at the processing stage and higher energy requirements due to frozen storage (factory, retailer and household).

Chestnut distribution to Rome by truck presented the highest life-cycle impacts in three impact categories, not only because of the distribution itself (truck had higher impacts than ship), but also because the electricity mix in Italy had higher environmental impacts, except for FWE, in which the highest impacts were calculated for Lisbon, mainly due to electricity consumption in household stage (the Portuguese mix had a higher impact on this category).

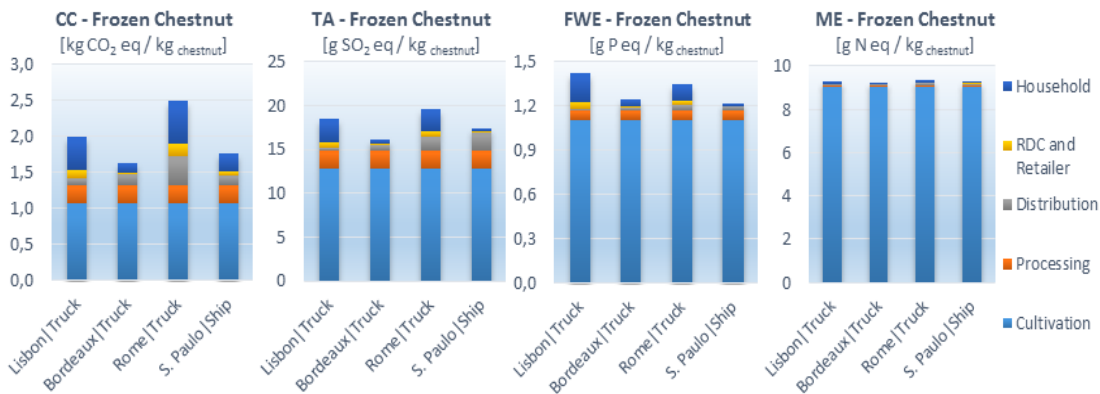

Figure 2: Life-cycle environmental impacts of frozen chestnut

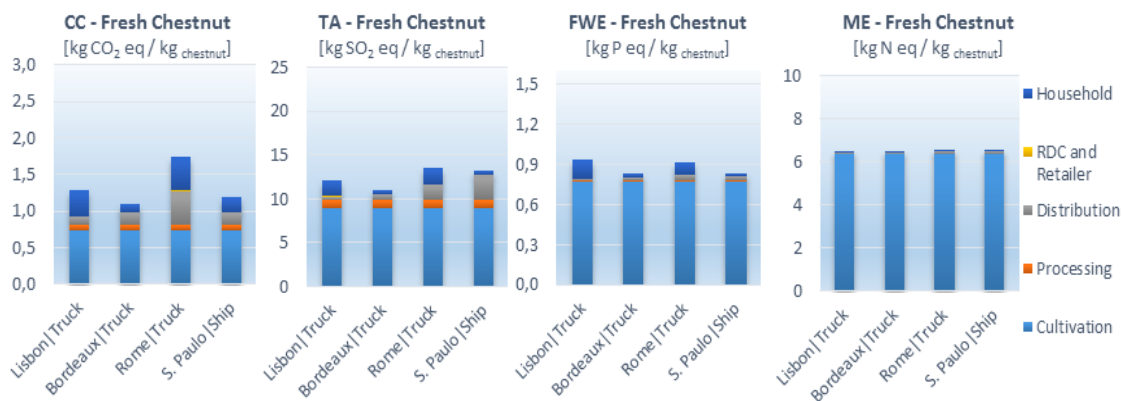

Figure 3: Life-cycle environmental impacts of fresh chestnut

## 5. Conclusions

This paper assessed the life-cycle environmental impacts of fresh and frozen chestnut produced in the north of Portugal and distributed for consumption in and outside Portugal. The cultivation stage presented the most significant contribution to the environmental impacts of both fresh and frozen chestnut (mostly due to diesel requirements and fertilizer use). Frozen chestnut presented higher impacts than fresh, in all impact categories, mainly because of higher losses of the processing of frozen chestnut as well as the additional energy requirements with refrigeration (factory, retailer and household).

The results showed the importance of improving resource management practices at the cultivation stage, namely an efficient use of fertilizers and fossil fuels. Additionally, increasing chestnut yield is critical to reduce the overall impacts, followed by the minimization of chestnut losses in the processing of harvested chestnut to fresh and frozen chestnut.

## 6. References

- [1] Food and Agriculture Organization of the United Nations (FAO), 'Production of Chestnut by countries', Statistics Division, (2015).
- [2] Instituto Nacional de Estatística (INE), 'Estatísticas Agrícolas 2013', (Lisboa, 2014).
- [3] Instituto Nacional de Estatística (INE), 'Castanha', Código NC: 08024000, (2013).
- [4] Rosa, D., 'Life-cycle assessment of chestnut and tomato in Portugal', Environmental Engineering Integrated Master Thesis, University of Coimbra, (Portugal, 2014).
- [5] Rosa, D., Figueiredo, F., Castanheira, É., Feliciano, M., Maia, F., Santos, J., Silva, A., Trindade, H. and Freire, F., 'Life-cycle greenhouse gas assessment of Portuguese chestnut', Energy for Sustainability 2015 – Designing for People and the Planet, (Coimbra, Portugal, 2015).
- [6] Rosa, D., Figueiredo, F., Castanheira, E., Freire, F., 'Life-cycle assessment of fresh and frozen chestnut' (2015) (Submitted for publication).
- [7] Intergovernmental Panel on Climate Change (IPCC), 'IPCC Guidelines for National Greenhouse Gas Inventories - volume 4: Agriculture, Forestry and Other Land Use', (Hayama, Japan, 2006).
- [8] Nemecek, T., Schnetzer, J., 'Methods of assessment of direct field emissions for LCIs of agricultural production systems', Agroscope Reckenholz-Tänikon Research Station ART, (Zurich, Switzerland, 2012).
- [9] Nemecek, T., Kägi, T., Blaser, S., 'Life Cycle Inventories of Agricultural Production Systems', ecoinvent report version 2.0, vol. 15, Swiss Centre for LCI, ART, (Dübendorf and Zurich, 2007).
- [10] Garcia, R., Marques, P., Freire, F., 'Life-cycle assessment of electricity in Portugal', Journal of Applied Energy, 134, (2014), 563-572.
- [11] Jungbluth, N., 'Erdöl. Sachbilanzen von Energiesystemen', final report no. 6, ecoinvent data v2.0, vol. 6, Swiss Centre for LCI, PSI, (Dübendorf and Villigen, 2007).
- [12] Environmental Protection Agency (EPA), 'Liquefied Petroleum Gas Combustion', Emissions Factor Documentation for AP-42, Section 1.5.
- [13] Kellenberger, D., Althaus, H., Jungbluth, N., Künniger, T., 'Life Cycle Inventories of Building Products', final report no. 7, ecoinvent data v2.0, Swiss Centre for Life Cycle Inventories, (Dübendorf, CH, 2007).
- [14] Hischier, R., 'Life Cycle Inventories of Packaging and Graphical Paper', final report no. 11, ecoinvent data v2.0, Swiss Centre for Life Cycle Inventories, (Dübendorf, CH, 2007).
- [15] Spielmann, M., Bauer, C., Dones, R., and Tuchschnid, M., 'Transport Services', ecoinvent report no. 14, Swiss Centre for Life Cycle Inventories, (Dübendorf, CH, 2007).
- [16] Cerutti, A., Bruun, S., Beccaro, G., Bounous, G., 'A review of studies applying environmental impact assessment methods on fruit production systems'. J. Environ. Manag. 92 (2011), 2277-2286.

## 7. Acknowledgements

This research was supported by ECODEEP project (Eco-efficiency and Eco-management in the Agro Industrial sector, FCOMP-05-0128-FEDER-018643), FEDER funds through "Programa Operacional Factores de Competitividade" - COMPETE and by the Portuguese Science and Technology Foundation (FCT) project FCOMP-01-0124-FEDER-029055 (PTDC/EMS-ENE/1839/2012) and project FCOMP-01-0124-FEDER-021495 (PTDC/SEN-TRA/117251/2010).

# Life Cycle Impact Assessment: needs and challenges for assessing food supply chains



# Pesticide Substitution: Combining Food Safety with Environmental Quality

Fantke, Peter

Quantitative Sustainability Assessment Division, Department of Management Engineering,  
Technical University of Denmark, 2800 Kgs. Lyngby, Denmark

E-mail contact: [pefan@dtu.dk](mailto:pefan@dtu.dk)

## 1. Abstract

*Various pesticides are authorized for use on agricultural food crops. Despite regulatory risk assessments aiming at ensuring consumer and environmental safety, pesticides contribute to human and environmental impacts. Guidance is needed to optimize pesticide use practice and minimize human and environmental exposure. Comparative pesticide substitution scenarios are presented to address this need. In a case study on wheat, different pesticides have been compared with respect to their substitution potential with focus on human health. Results demonstrate that health impacts can be reduced up to 99% by defining adequate substitution scenarios. Comprehensive scenarios need to also consider worker and environmental burden, and information on crop rotation, pest pressure, environmental conditions, application costs and efficacy. Such scenarios help to increase food safety and more sustainable use of pesticides.*

## 2. Introduction

A large variety of pesticides and plant growth regulators are authorized in Europe and elsewhere for use on various agricultural food crops. Chemical risk assessments are being constantly conducted as part of the authorization procedure of pesticides, aiming to ensure occupational, consumer and environmental safety. However, the use of agricultural pesticides nevertheless contributes to the global human disease burden, mainly via occupational and bystander exposure, but also via consumer exposure to crop residues [1, 2]. Moreover, pesticides can escape agricultural fields via wind drift, run-off events and leaching through the field soil column, thereby also contributing to contamination of groundwater and non-target ecosystems [3, 4]. Farmers growing food crops can optimize their pesticide use in every-day practice to minimize human and environmental impacts, but guidance for such optimization is currently missing. Thereby, comparative approaches from life cycle impact assessment (LCIA) are required to look beyond arbitrary safety limits toward true risk minimization. In this study, we aim at introducing comparative substitution scenarios combining crop-specific pesticide amounts applied with pesticide-specific toxicity potentials for humans, as such substitution scenarios can help to characterize and minimize consumer health burden from pesticide use and can be extended to include other aspects, such as occupational and environmental health [5].

## 3. Methods

First, human health impacts of several hundred pesticides were quantified, and residues in food crops grown and harvested for human consumption were identified as main contributor to overall human exposure toward agricultural pesticides for the general population for most pesticide-crop combinations [6]. Modeled crop residues were compared against measurements in several case studies showing (a) that modeled data are generally well in line with measured data and (b) that with the assumptions of typical application times and amounts (compared to worst-case assumptions as in risk assessment), residues are typically below regulatory maximum residue limits (MRL) [5, 7-9].



Further analyzing a subset of pesticides that are used in Europe, however, shows that only 10% of all considered pesticides applied to grapes/vines, fruit trees, and vegetables account for 90% of total annual human health impacts of around 2000 disability-adjusted life years [2]. Main aspect driving crop residue dynamics and parameter uncertainty is thereby pesticide dissipation from crops, for which data quality has subsequently been significantly improved based on fitting 4500 measured dissipation data points [10]. Exposure to crop residues has then been implemented in current LCIA methods as input for developing and evaluating comparative substitution scenarios with the aim to simultaneously improve the growing need for food safety, meet environmental quality targets and guide farmers to optimize agricultural practice with respect to pesticide use. In a case study on wheat, different pesticides have been finally compared with respect to their substitution potential with focus on consumer health as one of several performance indicators for pesticide substitution.

	scenario	pesticide	target pests***				m <sub>app</sub>	IS <sub>substance</sub>	IS <sub>class</sub>	θ <sub>IS</sub>
			A	B	C	D				
insecticides	#1	β-cyfluthrin	x	x	x		13.75	2.3E-09	1.5E-06	100%
		carbaryl		x	x	x	1.48	1.5E-06		
	#2	cyhalothrin	x	x	x	x	0.008	2.6E-09	2.6E-09	0.2%
		esfenvalerate		x	x	x	0.012	2.6E-11		
	#3	α-cypermethrin	x	x	x	x	0.015	2.3E-12	7.3E-12	<0.1%
		deltamethrin	x	x	x	x	0.009	5.0E-12		
fungicides	#1	cyproconazole	x	x	x	x	0.08	6.7E-05	6.9E-05	100%
		azoxystrobin	x	x	x	x	0.238	2.1E-06		
	#2	epoxiconazole	x	x	x	x	0.125	1.3E-05	1.3E-05	18.4%
		pyraclostrobin	x	x	x	x	0.175	2.0E-08		
		fenpropimorph		x	x	x	0.45	6.6E-12		
	#3	tebuconazole		x		x	0.219	9.7E-09	8.7E-07	1.3%
		chlorothalonil	x	x	x		1.5	7.4E-07		
		mancozeb	x	x	x		2.35	1.2E-07		
herbicides	#1	pendimethalin	x	x			1.4	8.7E-12	2.0E-11	100%
		fenoxaprop-p	x		x		0.069	1.1E-11		
		prosofocarb	x	x		x	3.5	1.0E-19		
	#2	iodosulfuron		x	x		0.01	7.5E-16	7.6E-16	<0.1%
		propoxycarbazone-sodium	x			x	0.05	3.8E-18		
	#3	glyphosate	x	x	x	x	1.37	8.8E-22	8.8E-22	<0.1%

Table 1: Overview of tested scenarios with pesticides, target species, mass applied m<sub>app</sub> [kg/ha], impact score per pesticide IS<sub>substance</sub> [DALY/ha], impact score aggregated over target class IS<sub>class</sub> [DALY/ha], and relative impact score θ<sub>IS</sub> normalized to scenario #1 for three pesticide substitution scenarios on wheat.

\*\*\* A: wheat bulb fly (*Delia coarctata*), B: cereal leaf beetle (*Oulema melanopa*), C: aphids (Aphidoidea), D: thrips (*Thysanoptera*), E: septoria leaf blotch (*Mycosphaerella graminicola*), F: wheat leaf rust (*Puccinia triticina*), G: wheat yellow rust (*Puccinia striiformis*), H: powdery mildew (*Blumeria graminis* f. sp. *Triticum*), J: slender meadow foxtail (*Alopecurus myosuroides*), K: annual meadow grass (*Poa annua*), L: common wild oat (*Avena fatua*), M: couch grass (*Elytrigia repens*).

#### 4. Results and Discussion

In the substitution case study, it is demonstrated that for a function-based evaluation of pesticides consumer health impacts can be reduced up to 99% by defining adequate substitution scenarios. Table 1 summarizes the information for the three scenarios of substituting a mix of (a) insecticides, (b) fungicides and (c)



herbicides based on the combination of applied dose and human toxicity potential. Data on the common wheat pests are derived from [11, 12]. We recommend that such scenarios further include occupational and environmental burden, combined with information on crop rotation, pest pressure, environmental conditions, pesticide authorization, and pesticide-specific application costs, efficacy, and finally application practice as function of local conditions and national regulations.

## 5. Conclusion

It was demonstrated that substitution scenarios can be used as a powerful tool to evaluate different authorized pesticide combinations with respect to relevant performance indicators, such as human health. Guidance can be based on LCIA-based comparative assessment methods, using aggregated metrics (such as DALY) to comparatively incorporate multiple indicators, and integrating all relevant aspects influencing agricultural pesticide use, fate and exposure into a consistent set of pesticide use scenarios. With that, it will be possible for farmers to optimize their day-to-day pesticide use practice with focus on minimizing health and environmental impacts. Such substitution scenarios, hence, can contribute to ensuring a world with increased food safety and a more sustainable use of pesticides, thereby acknowledging pesticide regulations, spatiotemporal differences in pesticide use and efficacy and farming conditions.

## 6. References

- [1] Prüss-Üstün, A., Vickers, C., Haefliger, P. and Bertollini, R., 'Knowns and unknowns on burden of disease due to chemicals: A systematic review', *Environ. Health* 10 (1) (2011) 9-23.
- [2] Fantke, P., Friedrich, R. and Jolliet, O., 'Health impact and damage cost assessment of pesticides in Europe', *Environ. Int.* 49 (2012) 9-17.
- [3] Takahashi Y. and Ogiyama, K., 'Development of estimation methods for movement of applied pesticide in farmlands', *J. Pestic. Sci.* 32 (2) (2007) 139-140.
- [4] Mottes, C., Lesueur-Jannoyer, M., Le Bail, M. and Malézieux, E., 'Pesticide transfer models in crop and watershed systems: A review', *Agron. Sustain. Dev.* 34 (1) (2014) 229-250.
- [5] Fantke, P., Juraske, R., Antón, A., Friedrich, R. and Jolliet, O., 'Dynamic multicrop model to characterize impacts of pesticides in food', *Environ. Sci. Technol.* 45 (20) (2011) 8842-8849.
- [6] Fantke, P. and Jolliet, O., 'Life cycle human health impacts of 875 pesticides', *Int. J. Life Cycle Assess.* (2015) doi:10.1007/s11367-015-0910-y.
- [7] Juraske, R., Fantke, P., Romero Ramírez A.C. and González, A., 'Pesticide residue dynamics in passion fruits: Comparing field trial and modeling results', *Chemosphere* 89 (7) (2012) 850-855.
- [8] Itoiz, E.S., Fantke, P., Juraske, R., Kounina, A. and Antón Vallejo, A., 'Deposition and residues of azoxystrobin and imidacloprid on greenhouse lettuce with implications for human consumption', *Chemosphere* 89 (9) (2012) 1034-1041.
- [9] Fantke, P., Charles, R., de Alencastro, L.F., Friedrich, R. and Jolliet, O. 'Plant uptake of pesticides and human health: Dynamic modeling of residues in wheat and ingestion intake', *Chemosphere* 85 (10) (2011) 1639-1647.
- [10] Fantke, P., Gillespie, B., Juraske, R. and Jolliet, O., 'Estimating half-lives for pesticide dissipation from plants', *Environ. Sci. Technol.* 48 (15) (2014) 8588-8602.
- [11] Jørgensen, L.N., Hovmøller, M.S., Hansen, J.G., Lassen, P., Clark, B., Bayles, R., Rodemann, B., Jahn, M., Flath, K., Goral, T., Czembor, J., du Cheyron, P., Maumene, C., de Pope, C. and Nielsen, G. C., 'EuroWheat.org - A Support to Integrated Disease Management in Wheat' *Outlooks Pest Manage.* 21 (4) (2010) 173-176.
- [12] Prescott, J.M., Burnett, P.A., Saari, E.E., Ranson, J., Bowman, J., de Milliano, W., Singh, R.P. and Bekele, G., 'Wheat Diseases and Pests: A Guide for Field Identification', (International Maize and Wheat Improvement Center, Mexico, 1986).

# Building consensus for assessing land use impacts on biodiversity: contribution of UNEP/SETAC's Life Cycle Initiative

Assumpció Antón<sup>1</sup>, Ottar Michelsen<sup>2</sup>, Ricardo F.M. Teixeira<sup>3</sup>, Danielle M. Souza<sup>4</sup>, Michael Curran<sup>5</sup>, Serenella Sala<sup>6</sup>,  
Beatriz Vidal-Legaz<sup>6</sup>, Llorenç Milà i Canals<sup>7</sup>

<sup>1</sup>Institute for Food and Agricultural Research and Technology, IRTA, Cabrils, Barcelona, Spain

<sup>2</sup>Norwegian University of Science and Technology, Trondheim, Norway

<sup>3</sup>University of Antwerp, Research Group of Plant and Vegetation Ecology, Wilrijk, Belgium

<sup>4</sup>Swedish University of Agricultural Sciences, Department of Energy and Technology, Uppsala, Sweden

<sup>5</sup>Institute of Environmental Engineering, ETH Zurich, Zurich, Switzerland

<sup>6</sup>European Commission, Joint Research Centre, Institute for Environment and Sustainability, Ispra, Italy

<sup>7</sup>United Nations Environment Programme, Division of Technology, Industry and Economics, Paris, France

E-mail contact: [assumpcio.anton@irta.cat](mailto:assumpcio.anton@irta.cat)

## 1. Abstract

*Land use interventions is one of the main drivers of biodiversity loss and degradation of a broad range of ecosystem services. In the frame of LCA there is not clear consensus yet on the use of (a) specific impact indicator(s) to quantify land use impacts on biodiversity. The UNEP SETAC Life Cycle Initiative has successfully provided a platform for consensus finding. In order to achieve this goal Land Use Taskforce has conducted two expert workshops where stakeholders agreed on the requisites of good biodiversity indicators. In parallel, current land use impact assessment methodologies have been reviewed according to specific criteria of completeness, environmental relevance and applicability. The work conducted till now provides the needed framework where establish a clear guidance towards consensus for assessing land use impacts on biodiversity.*

## 2. Introduction

Environmental impacts of production and consumption are increasingly coming into the focus of companies and governments. Life Cycle Assessment (LCA) is one of the most important approaches to quantify environmental impacts of products and processes from cradle to grave. Applied as a decision-making tool and/or as a support to policy development, it makes use of indicators to consider different environmental aspects over a system's life cycle. With increasing economic globalization, there has been a steadily growing need to create a worldwide consensus set of environmental indicators.

The UNEP SETAC Life Cycle Initiative has successfully provided a platform for consensus finding in the area of environmental indicators in LCA. A flagship project was established in 2012 intended to run a global process aiming at global guidance and consensus building on a limited number of environmental indicators, including indicators for assessing impacts from land use (LU) and land use change (LUC) interventions on biodiversity. LU/LUC are some of the main drivers of biodiversity loss and degradation of a broad range of ecosystem services. The need for consensus arises from the fact that, despite substantial contributions to address biodiversity in LCA, no clear consensus exists yet on the use of (a) specific impact indicator(s) to quantify land use impacts on biodiversity within LCA. This lack of agreement not only limits the application of models, but also imposes constraints on the comparability of results of different studies evaluating land use impacts.

Until the end 2015 the taskforce will deliver input to a global guidance workshop where invited experts and stakeholders discuss and agree on the final conclusions, in early 2016. This input will include the critical review of the existing framework for LU/LUC impact assessment in LCA, plus a brief review of existing indicators and guidance on how to establish regional impact indicators. The report from the task force will focus on key elements for consensus, and on the crucial developments needed to steer impact assessment methods developers in the right direction.

In this paper we show how the Initiative's taskforce on biodiversity engaged stakeholders and reviewed current impact assessment methodologies presenting results available to date from two expert workshops where stakeholders agreed on the requisites of good biodiversity indicators and we also present results from a consistent review of current biodiversity impact assessment methodologies.

### **3. Material and Methods**

The objective of the flagship project on biodiversity is to conduct an overarching process aiming at global guidance and consensus regarding indicators and methods for the assessment of biodiversity impacts from Land use in LCA. To succeed in this task, this global effort involved assembling a team of LCA experts together with biologists, ecologists and experts in other relevant disciplines. There have been two crucial tasks already completed by the taskforce: 1) organization of two stakeholders workshops and 2) an evaluation procedure of land use impact assessment methodologies with biodiversity indicators. Each task has been reflected in the preparation of two papers Teixeira et al (*submitted JCP*) and Curran et al (*in preparation*) respectively. Next step will be the application of selected methods in a common case study of the UNEP SETAC Life Cycle Initiative Flagship project "Global guidance on environmental life cycle impact assessment indicators.

#### *3.1 Workshops*

The main goal of both workshops was the engagement of different stakeholders in order to obtain inputs from specialized domain experts on the assessment framework and indicators. The first 'Expert Workshop on Biodiversity Impact Indicators for Life Cycle Assessment' took place in San Francisco on October 7<sup>th</sup>, hosted by the US EPA. The workshop was attended by fourteen invited top experts in biodiversity metrics, LCA and ecology, as well as institutional and business partners. The second workshop took place in Brussels on November 18 and 19, hosted by the Confederation of European Paper Industries (CEPI). It was attended by twenty-four invited experts from equally diverse backgrounds. The workshops were used to agree on the main aspects an assessment method for biodiversity assessment must possess, while the evaluation of methods applied specific criteria in order to determine the most likely candidates for consensus.

#### *3.2 Model evaluation*

After a thorough revision of different LCA and non-LCA methodologies to assess biodiversity loss due to land use interventions, 30 models were included in the final assessment, of which 19 were developed specifically for impact assessment in LCA and 11 originated from non-LCA fields (environmental policy, ecology and conservation) (Curran et al, *in preparation*).

To evaluate the models, we adopted a review framework based on the approach used by the European Commission within the International Reference Life Cycle Data System, on the evaluation of LCIA models and indicators (EU-JRC 2011).

We grouped sets of evaluation criteria under the following categories: (i) “Completeness of scope”; (ii) “Biodiversity representation”; (iii) “Impact pathway coverage”; (iv) “Scientific quality; (v) “Model transparency and applicability”; and (vi) “Stakeholders acceptance”. Under each of these evaluation categories, we developed a set of specific criteria, and qualitatively described the degree to which each model fulfilled each criterion. For each model, we first summarized the main model characteristics, including the indicator(s) used to represent biodiversity, their position on the cause-effect chain (impact pathways) leading from land use interventions to biodiversity loss, as well as the underlying data upon which model was based (e.g. literature data, expert opinion, Habitat Suitability Models, Species Distribution Models).

## **4. Results and discussion**

### *4.1 Main expert recommendations*

The experts who participated in the workshops highlighted the importance of the framework established by the Life Cycle Initiative, including the early engagement of stakeholders in the consensus-building process. Experts agreed that LCA should go beyond inventory data for LU/LUC and relate elementary flows to their respective impacts on biodiversity. A crucial point is how results are communicated. During the workshops, there was also an agreement that a good LCA indicator for biodiversity necessarily has to include geographical location, several aspects that depict the state of ecosystems at that location, and a measure of land use intensity. Species richness is a good starting point for assessing biodiversity loss, with the additional advantage that it is an indicator often used by LCIA developers. However, complementary metrics need to be considered in modelling, such as habitat configuration, including fragmentation and vulnerability, and intensity-based indicators (NPP/HANPP) (Teixeira et al, *submitted*)

### *4.2 Biodiversity loss assessment models evaluation*

The evaluation task has shown that different methods use different spatial scales of assessment. The ecoregion spatial unit is probably the one with major consensus. In terms of coverage of biogeographic representation, most methods focus on the Palearctic (PA) realm. Depending on the model several taxonomic groups are covered in the model, in particular plants, which are the most common taxon assessed. As concerns to land use classes and the different use intensity, the variability is highly dependent on the purpose of the study. Regarding biodiversity representation most of the current methods are based on compositional aspects of biodiversity, namely species richness.

The most common pathway assessed was the direct, local degradation and conversion of habitats. Concerning scientific quality models chosen are well documented, as far as it was a preliminary condition to be evaluated however uncertainty of the models are partially and non uniformly covered. Finally, even though any of the methods assessed could be considered currently enough mature to be accepted and directly applicable, there are a lot of work done, which will be an important input to provide guidance for the assessment of biodiversity impacts from land use.

## **5. Conclusions**

The work conducted by the LC Initiative has allowed to integrate different expertise and evaluate various methodologies. Although it is clear that the assessment of biodiversity impacts resulting from land use is an extremely complex subject, the taskforce has provided a framework with more clear guidance on indicators and models. The consensus-finding process will end with a SETAC Pellston workshop next January 2016 in Valencia, Spain, where invited experts and stakeholders discuss and agree on the final conclusions.

## **6. References**

- [1] EU-JRC. European Commission-Joint Research Centre. International Reference Life Cycle Data System (ILCD) Handbook: Recommendations for Life Cycle Impact Assessment in the European context. First edition, November 2011. EUR 24571. Luxemburg. Publications Office of the European Union. (2011) 143pp
- [2] Teixeira, R.F.M., Souza, D.M. de, Curran, M.P., Antón, A., Michelsen, O., Milà Canals, M. Towards consensus on land use impacts on biodiversity in LCA: UNEP/SETAC Life Cycle Initiative preliminary recommendations based on expert contributions. *J Cleaner Prod* (submitted)
- [3] Curran et al. Building consensus on biodiversity modelling in life cycle assessment: evaluation of current practice in land use impact assessment (in preparation)

# Coupling land use information with remotely sensed spectral heterogeneity: a new challenge for life cycle impact assessment of plant species diversity

Benedetto Rugani<sup>1</sup>, Duccio Rocchini<sup>2</sup>

<sup>1</sup> Luxembourg Institute of Science and Technology – LIST, Dept. Environmental Research and Innovation – ERIN / 41 rue du Brill, L-4422 Belvaux, Luxembourg

<sup>2</sup> Fondazione Edmund Mach, Research and Innovation Centre, Dept. Biodiversity and Molecular Ecology, GIS and Remote Sensing Unit / Via Mach 1, 38010 San Michele all'Adige (TN), Italy

E-mail contact: [benedetto.rugani@list.lu](mailto:benedetto.rugani@list.lu)

## 1. Abstract

*Remotely sensed spectral heterogeneity (SH) is a viable proxy measure for species diversity detection, and is introduced here as a complementary approach to current Life Cycle Impact Assessment–LCIA practice to expand its scope for evaluation of impacts from human-driven land use change on biodiversity. This rationale is based on the ‘spectral variation hypothesis’: the higher the spectral variability, the higher the ecological heterogeneity and species community diversity, occupying different niches. Focusing on the local scale of food crops cultivation in Southern Alps (area of Trentino Region, IT), we observe the relationships between land cover maps and habitat heterogeneity at different time and spatial resolutions, allowing us to argue about the robustness and potentials of SH to be a surrogate measure of cross-taxon, within-taxon or environmental nuances for species variability detection in LCIA.*

## 2. Introduction

One of the major challenges in the field of Life Cycle Impact Assessment (LCIA) is to develop consensual and operational methods to assess the human pressure on biodiversity [1, 2]. In this regard, Souza et al. [3] observe that there is a general lack of consistent landscape oriented approaches to evaluate biodiversity in LCIA, and thus recommend developing impact characterization factors (CF) for application at multiple spatial scales (local, regional, global), e.g. by replacing land cover maps with continuous environmental information, and including landscape aspects such as habitat fragmentation or connectivity of ecosystems. Hence, we seek responding to ‘this’ call, by acquainting on a novel approach that could potentially place a step forward the appraisal of spatial variability of vascular plant species in LCIA. This approach is presented here with a focus on local scale agri-food croplands taken as a case study. It is based on the use of remotely sensed imagery, which is to predict plant species spatial distribution at broad scale, in a timely manner and with a certain degree of confidence [4], through e.g. the identification of unique reflectance or absorption features [5]. As an example, the variability of the spectral signal over space, i.e. Spectral Heterogeneity–SH, is considered a viable proxy for species diversity detection [6]. While the effectiveness of geospatial tools for the extrapolation of information on biodiversity is known in LCIA [7], no concrete examples exist of incorporating remote sensing information in the LCIA of plant biodiversity. Nevertheless, SH offers a plethora of solutions to analyse the relationship between plant species communities or taxonomic groups and local biophysical components, allowing to assess the anthropogenic alterations on ecosystems. Assuming the latter are described by land uses (LU) and LU Changes (LUC) in LCIA, and that human activities are the main cause for changes in habitat heterogeneity, it is ideally possible to refine/establish biodiversity potential

damage indicator(s) building on the observation and processing of remotely sensed imagery. An attempt of coupling SH with the typical LU information adopted in LCIA is illustrated in this paper.

### **3. Materials & Methods**

#### *3.1 Study area*

A study area in the Trentino Region, Italy, was selected for demonstration purposes, and because of raster data availability. The analysed area (centre: 48°11'08" N, 11°07'22" E, datum WGS84) is dominated by cropland, the majority of it made of viticulture land (> 90%). LUCs related to cropland were analysed to argue on the human induced effects on the local biodiversity due to agri-food supply-chain products over time. These LUCs were considered within a time frame of 30 years (from 1984 to 2014) using local data sources, observing a slight increase over time in viticulture land (as from Eurostat data source). However, the total cropland (the remaining cultivations be mostly apple orchards) did not remarkably change over time.

#### *3.2 Methodological steps*

Land cover data were superimposed to habitat heterogeneity maps at different time periods and spatial resolutions (or grains). In general, this can help finding statistically significant relationships between LU and LUC effects on plant species diversity, thus considering SH as a surrogate of cross-taxon, within-taxon or environmental surrogates. To this end, a Principal Component Analysis (PCA) was performed on two satellite images (a 1984 Landsat TM and a 2014 Landsat8 image) acquired in the same seasonal period (end of the autumn period). First PCA components (rescaled from 0 to 255) explained respectively 83% and 71% in the 1984 and 2014 images. Hence, they were used to calculate heterogeneity by 3×3 moving windows. Reprocessed pixels of the first component were scaled into the range 0-255 to standardize the magnitude of the input values by making the two images comparable on the 30 years. The whole processing was done in GRASS GIS 7.0 [8] and the code is available upon request. Final output of this approach was to obtain variation coefficients for the average SH over the 30 years of LUC in the local analysed area, considering different grains: total (SH calculated on the full cropland area), and disaggregated (SH for vineyards and the rest of croplands). This helped to infer on the statistical discrepancies between the mean heterogeneity in 1984 and in 2014, and thus to determine the influence of crop-LUC to biodiversity patterns at a very local scale.

### **4. Results & Discussion**

SH tends to decrease in all cases by 11% on average (increase in mean variability between SH variation coefficients in 1984 and in 2014) (Fig.1a, bottom). This is mainly due to shadows in the 2014 image. This discrepancy is considered too low to argue on the actual impact on plant biodiversity. In fact, Fig.1b shows that, while the mean SH decreases, the overall variability (standard deviation range) increases over time. However, the diversity between the three paired cases (total crop area, vineyards and other crops) is not statistically significant per  $p>0.05$  and  $p>0.01$ . Because of this, and even if occurring in terms of SH change according to the 'spectral variation hypothesis' [6], we can argue that changes in biodiversity patterns, at this very local scale are caused by factors other than LUC patterns (i.e. presence of shadows).

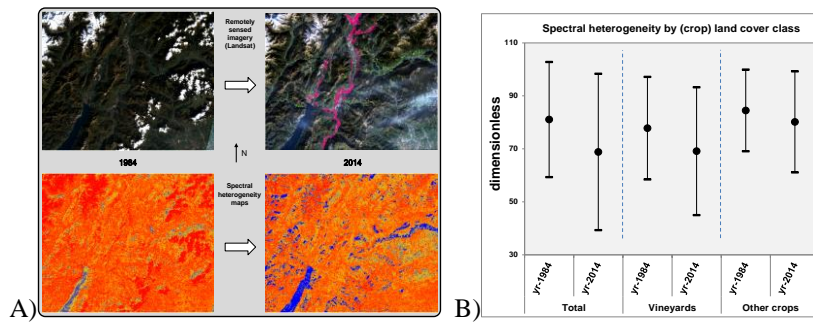

Figure 1: A) Elaboration by GRASS GIS of SH maps (bottom) from Landsat remotely sensed imagery (top; land use classes of vineyards (pink) and other cultures (green) are superimposed); B) variability (mean and standard deviation) in SH over considering different land cover hierarchical aggregations

The proposed SH-based approach can capture the changes associated with plant species diversity over time at multiple scales, by possibly linking lifecycle *land occupation* (~LU) and *transformation* (~LUC) flows with heterogeneity patterns. These could be translated in the LCIA jargon according to the hypothesis that variability in the remotely sensed signal relates to landscape diversity, which is considered a good proxy of diversity at species level [4, 6]. In this regard, for impact characterization at community and ecosystem scales, methods based on the SH rationale could complement existing CF calculations based on species-area relationship (SAR) [2, 9, 10], e.g. by improving the calculation of species richness factors in the SAR equation. It has been observed, for example, that spectral diversity is correlated with the area of each floras bounding box, because more habitats are expected to be present in larger areas, on average (which is analogous to the SAR rationale) [11]. Despite these opportunities, still some drawbacks and challenges must be overcome: 1) construction of a consistent mathematical framework to incorporate SH in LCIA; 2) quantitative comparison and/or combination with current LCIA methods; 3) the proposed SH approach can only address plant species diversity, without distinguishing among species abundance [7] or taxonomic groups.

## 5. Conclusion

This short paper illustrates a preliminary idea for potential development of SH-based CF for plant biodiversity in LCIA. An intensive research activity is still on-going to improve the analytical framework for routine assessment at multiple scales of land use and land use change. This could avoid using reference states or distance-to-target rationales, which are useful concepts to create archetypes but can also propagate large uncertainties in the calculation of CF for local scale assessments. Using times series SH maps (both annual and seasonal) can further reduce this subjectivity and uncertainty, while increasing the representativeness of biodiversity LCIA indicators (remotely sensed imagery provides ‘real’ state references).

## 6. Acknowledgements

Authors thank the National Research Fund Luxembourg (FNR) for financing this research within the VALUES project framework (C13/SR/5903117; [www.list.lu/en/project/values/](http://www.list.lu/en/project/values/)).



## 7. References

- [1] Curran M, De Baan L, De Schryver AM, Van Zelm R, Hellweg S, Koellner T, et al. Toward meaningful end points of biodiversity in life cycle assessment. *Environmental Science and Technology*. 2011;45:70–9.
- [2] de Baan L, Alkemade R, Koellner T. Land use impacts on biodiversity in LCA: a global approach. *Int J Life Cycle Assess*. 2013;18:1216-30.
- [3] Souza DM, Teixeira RFM, Ostermann OP. Assessing biodiversity loss due to land use with Life Cycle Assessment: are we there yet? *Global Change Biology*. 2015;21:32–47.
- [4] Rocchini D, Hernández-Stefanoni JL, He KS. Advancing species diversity estimate by remotely sensed proxies: A conceptual review. *Ecological Informatics*. 2015;25:22–8.
- [5] Gillespie TW, Foody GM, Rocchini D, Giorgi AP, Saatchi S. Measuring and modelling biodiversity from space. *Progress in Physical Geography*. 2008;32:203-21.
- [6] Rocchini D, Balkenhol N, Carter GA, Foody GM, Gillespie TW, He KS, et al. Remotely sensed spectral heterogeneity as a proxy of species diversity: Recent advances and open challenges. *Ecological Informatics*. 2010;5:318–29.
- [7] Geyer R, Lindner JP, Stoms DM, Davis FW, Wittstock B. Coupling GIS and LCA for biodiversity assessments of land use - Part 2: Impact assessment. *Int J Life Cycle Assess*. 2010;15:692-703.
- [8] Neteler M, Bowman MH, Landa M, Metz M. GRASS GIS: A multi-purpose open source GIS. *Environmental Modelling & Software*. 2012;31:124-30.
- [9] Verones F, Huijbregts MAJ, Chaudhary A, de Baan L, Koellner T, Hellweg S. Harmonizing the assessment of biodiversity effects from land and water use within LCA. *Environ Sci Technol*. 2015;49 3584–92.
- [10] De Schryver AM, Goedkoop MJ, Leuven RSEW, Huijbregts MAJ. Uncertainties in the application of the species area relationship for characterisation factors of land occupation in life cycle assessment. *International Journal of Life Cycle Assessment*. 2010;15:682-91.
- [11] Rocchini D, Dadalt L, Delucchi L, Neteler M, Palmer MW. Disentangling the role of remotely sensed spectral heterogeneity as a proxy for North American plant species richness. *Community Ecology*. 2014;15:37-43.

# Biodiversity impact: Case study beef production

Ulrike Eberle<sup>1</sup>, Jan-Paul Lindner<sup>2</sup>

<sup>1</sup>Private Universität Witten/Herdecke, Zentrum für Nachhaltige Unternehmensführung,  
Alfred-Herrhausen-Str. 50, D-58448 Witten

<sup>2</sup>Fraunhofer IBP dept. GaBi, Wankelstr. 5, D-70563 Stuttgart  
E-mail contact: [ulrike.eberle@uni-wh.de](mailto:ulrike.eberle@uni-wh.de)

## 1. Abstract

*Aim of the presented case study was to analyse and compare the impacts on biodiversity of beef from milk cows produced in southern Germany. For this purpose two farms with different feeding concept but similar in size have been analysed. Impact assessment was carried out following a newly developed methodology [1], which consists of a screening to identify most relevant processes with respect to biodiversity and a two part biodiversity assessment: a detailed assessment for the most relevant processes combined with a rough estimation for less relevant processes. Results in this case study show that the farm with the lower feed ration causes an one third lower biodiversity impact. The most relevant processes depend on the feeding concept, for one farm it is green fodder production, for the other it is grain and corn production.*

## 2. Introduction

The presented case study was carried out within a research project developing a methodology for impact assessment of land use on biodiversity. Aim of the case study was to analyse and compare the impacts on biodiversity of beef from milk cows produced by two farms in South Germany as by-product in dairy production.

## 3. Methods

### 3.1 Functional unit and systems

Functional unit of the study is 1 kg milk cow at the age of being slaughtered. The system boundary was set at the gate of the farm.

The size of the two analysed farms is more or less similar, but there is a big difference in the feeding concept: farm A is producing most of the feed on the farm, farm B buys most of the feed needed. Also fodder composition is very different: farm A feeds mostly green fodder, farm B mainly concentrated feed. Another difference between the two farms is the amount of fodder for the milk cows. The data used for the feeding concept and agricultural processes of the two farms are specific, measured data obtained directly from the farms. Table 1 and 2 show the data used for feeding.

### 3.2 Allocation

Most important allocation methodology used was economic allocation to allocate impacts to milk, calves, and beef, resulting in 2% of material flows allocated to beef.

Furthermore in fodder production several allocation were necessary. Main allocation method used for this purpose was mass allocation, e.g. regarding straw, grain bran, coarse colza meal and soy shred.

### 3.3 Impact assessment

The methodology used for biodiversity impact assessment was developed by Lindner et al. [1] which aims at capturing biodiversity as a whole rather than singular aspects like species number, abundance of specific taxa

or habitat composition. It consists of a screening to identify the most relevant processes regarding biodiversity and the biodiversity impact assessment which is carried out in detail for most relevant processes and on a rough basis for less relevant processes. The detailed analysis first requires to identify relevant input parameters regarding biodiversity impact in the analysed region. As all relevant processes in this case study take place in the same ecoregion (PA0445, Western European broadleaf forests), these input parameters are the same for both farms. As input parameters have been identified pesticide use, fertilizer use, biomass use and two parameters regarding structural diversity (share of small structural elements such as hedges or tree groups, and the number of cultivated crops). Subsequently, for every input parameter a mathematical function is defined, and results of the input parameter assessments are aggregated to the biodiversity impact of the process under investigation. Finally, biodiversity impacts for all processes are summed up.

#### **4. Results**

Results of the screening showed that for both farms all agricultural feed production processes on the farm are relevant regarding biodiversity and have to be analysed in further detail. But also some of the production processes of the purchased fodder are of high relevance. In particular coarse colza meal production but also many ingredients of the concentrated feed, like wheat and wheat derivatives are of high importance. All other processes are of less importance but there is no process which is negligible. Figure 1 shows the results of the screening for both farms.

In the further detailed assessment of biodiversity impacts all green marked processes have been included, the orange marked processes have been roughly estimated.

Results show that the impact of farm A which produces fodder mainly on the farm and uses in particular green fodder has a one third lower impact than farm B. The most relevant process for farm A therefore is green fodder production (95% of biodiversity impact), with grass having a share of 60% in biodiversity impact but 74% in mass. Regarding lucerne it is the other way round: the mass share is 19% but the share in biodiversity impact is 30%, reflecting the higher input of fertilizers and pesticides for lucerne production. The most relevant processes of farm B are grain (wheat, wheat products, oat) and corn production which represent together 95% of the biodiversity impact but only 75% of mass. Tables 1 and 2 show the results of the biodiversity impact assessment.

For soy shred it has been analysed if and in which way the used methodologies for biodiversity impact assessment (detailed analysis, rough estimation) influence the results. Based on specific data of three farms in Brazil in Mato Grosso do Sul a detailed biodiversity impact assessment has been carried out and results have been compared with the results of the rough estimation (Table 3). Results show that on the one hand biodiversity impact of soy producing farms is varying by about 25% for the three farms analysed, and on the other hand that results of detailed analysis and rough estimation are in the same magnitude of order.

farm A

area occupation [%]	>10%			green fodder
	1-10%	coarse colza meal		grains
	<1%	soy shred fertilizers pesticides electricity diesel other energy	straw	maize
		2	1	0
		tier of supplier		

farm B

area occupation [%]	>10%	coarse colza meal wheat		
	1-10%	maize corn meal corn gluten feed wheat bran wheat middlings oat bran		green fodder
	<1%	Soy shred sugar beet pulp wheat gluten distillers grain sugar beet molasses pesticides electricity diesel other energy fertilizers		
		CaCO <sub>3</sub> NaCl	straw	
		2	1	0
		tier of supplier		

Figure 1: Relevance of processes due to screening  
(green: high relevance, orange: medium relevance, red: low relevance)

Process	Biodiversity impact/FU	Share of impact	Mass /energy [kg/FU resp. MJ/FU]	share of mass / energy
coarse colza meal	9.04	2%	0.137	1.5%
green fodder (lucerne)	131.20	30%	1.785	19.1%
grains (winter barley)	0.94	0.2%	0.016	0.2%
grains (summer wheat)	0.93	0.2%	0.016	0.2%
grains (triticale)	0.93	0.2%	0.016	0.2%
green fodder (grass)	286.35	65%	6.930	74.2%
Maize	9.00	2%	0.134	1.4%
Straw	0.66	0.1%	0.172	1.8%
soy shred	2.86	1%	0.137	1.5%
Fertilizers	1.88E-04	0.00004%	41.390	99.998%
pesticides	1.09E-05	0.000002%	0.0007	0.002%
electricity	0.20	0.04%	4.909	3.2%
Diesel	0.01	0.002%	146.127	96.7%
other energy	1.46E-05	0.000003%	0.112	0.1%
<b>SUM</b>	<b>442.11</b>		<b>9.34</b>	kg fodder
			<b>41.39</b>	kg fertilizers&pesticides
			<b>151.15</b>	MJ

Table 1: results of biodiversity impact assessment for farm A per functional unit (FU) (grey: estimated processes, yellow: mass of fodder, blue: mass of fertilizers & pesticides, orange: energy)

Process	Biodiversity impact/FU	Share of impact	Mass [kg/FU resp. MJ/FU]	Share of mass/energy
coarse colza meal	6.30	1.0%	0.092	0.5%
Wheat	364.02	56.7%	3.666	18.8%
corn meal	87.47	13.6%	1.222	6.3%
corn gluten	43.60	6.8%	1.222	6.3%
wheat bran	68.46	10.7%	4.643	23.8%
wheat middlings	8.49	1.3%	2.199	11.3%
oat bran	37.50	5.8%	1.711	8.8%
green fodder (grass)	22.54	3.5%	1.296	6.6%
Straw	0.53	0.1%	0.076	0.4%
soy shred	0.95	0.1%	0.046	0.2%
sugar beet pulp	2.04E-06	0.0000003%	0.153	0.8%
distillers grain	0.00	0.0%	2.444	12.5%
sugar beet molasses	1.47	0.2%	0.733	3.8%
fertilizers	0.05	0.01%	21.111	99.99%
pesticides	6.50E-07	0.0000001%	0.002	0.01%
electricity	0.23	0.04%	15.541	1.9%
Diesel	0.07	0.01%	799.062	96.7%
other energy	7.14E-04	0.0001%	11.929	1.4%
<b>SUM</b>	<b>641.67</b>		<b>19.50</b>	kg fodder
			<b>21.11</b>	kg fertilizers&pesticides
			<b>826.53</b>	MJ

Table 2: Results of biodiversity impact assessment for farm B (grey: estimated processes, yellow: mass of fodder, blue: mass of fertilizers & pesticides, orange: energy)

	Farm 1	Farm 2	Farm 3	Estimation
Biodiversity impact of soy	0.530	0.695	0.699	0.65

Table 3: Comparison of detailed biodiversity impact assessment results and results of roughly estimation for soy

## 5. Conclusions

Feeding concepts of farm A and farm B are totally different: farm A produces most of the fodder on the farm, whereas farm B produces only green fodder itself. Most of the land is cultivated to produce biomass for the farm-owned bioenergy plant.

Furthermore the composition of fodder is very different. Farm A feeds mostly green fodder (grass, lucerne), farm B in a large part dairy concentrate.

But the key difference is the daily feed ration and the resulting gain in weight: farm A feeds a ration of 9.343 kg, farm B 26.116 kg and achieves a daily gain in weight which is 20% higher than that of farm A. But the higher gain in weight of farm B can not compensate the needed higher feed ration with respect to biodiversity impact. However, due to the huge difference in feed rations, the obtained specific data should be verified.

There are several methods for assessing biodiversity within the LCA framework, aside from the one demonstrated here, and they all have their merits and shortcomings. The FAO recently published a document listing a number of biodiversity indicators relevant for livestock herding [2]. Some are very similar to the inputs we use for our method. As stated above, the method employed in this case study aims at capturing biodiversity as a whole rather than singular aspects. It can be seen as a composite indicator.

## **6. Acknowledgements**

This work has been funded by the German Federal Agency for Nature Conservation (BfN). We are grateful for the support.

## **7. References**

- [1] Lindner, J.P. et al. (in print): Biodiversität in Ökobilanzen, Bundesamt für Naturschutz, Bonn, Germany
- [2] LEAP (2015): A review of indicators and methods to assess biodiversity – application to livestock production at global scale. Livestock Environmental Assessment and Performance Partnership. FAO, Rome, Italy.

# Pollinators in LCA: towards a framework for impact assessment

Eleonora Crenna<sup>1</sup>, Serenella Sala<sup>2</sup>, Chiara Polce<sup>2</sup> and Elena Collina<sup>1</sup>

<sup>1</sup>Department of Earth and Environmental Sciences, University of Milano-Bicocca,  
Piazza della Scienza 1, 20126 Milan, Italy

<sup>2</sup>European Commission, Joint Research Centre, Institute for Environment and Sustainability,  
Via E Fermi 2749, 21027 Ispra (Va), Italy  
E-mail contact: [e.crenna@campus.unimib.it](mailto:e.crenna@campus.unimib.it)

## 1. Abstract

*Several human interventions are threatening biodiversity at an unprecedented scale and pace, thus potentially affecting the provision of critical ecosystem services. Pollination is a crucial component of environmental and socio-economic well-being worldwide and accounting for it is fundamental in any effort that aims to enhance the sustainability of certain human activities. However, none of the existing life cycle impact assessment (LCIA) models effectively accounts for the role of pollinators and pollination services. The present study is a review of environmental pressures acting on pollinators and potentially threatening pollination services which represents the first step towards their integration in the LCIA framework. Starting from pollination as pivotal ecosystem service and pollinators as target group for protection, this review aims to identify the modelling needs for the impact assessment in the LCIA context.*

## 2. Introduction

In the last decades, several human interventions related to industrial development and agricultural intensification have threatened biodiversity at an unprecedented scale and pace, thus potentially affecting the provision of critical ecosystem services [1], including those related to insect pollination. Worldwide, a variety of insects plays an essential functional role in both managed and natural terrestrial ecosystems, being responsible, at the global level, for pollinating more than 80% of wild plant species and almost 75% of primary agricultural crop species [2]. Recently, insect pollinator populations have declined at local and regional scale, raising concerns in scientific and policy context regarding potential risks to natural ecosystem functioning, global food security and socio-economic sustainability. Therefore, accounting for pollination is fundamental in any effort that aims to assess the sustainability of human production and consumption patterns in certain activities, especially in the agri-food sector.

Previous studies have highlighted the main threats leading to pollinator population declines and potentially menacing the provision of pollination services [3]. However, to our knowledge no study so far has been conducted for integrating impacts deriving from agrochemical emissions, habitat conversion or similar human interventions on pollinators in the life cycle impact assessment (LCIA) framework. The present study is a review of the anthropogenic and environmental drivers exerting pressures on pollinators and it represents the first step towards the integration of pollinators and their services in the LCIA framework. Starting from pollination as pivotal ecosystem service and pollinators as target group for protection, this review aims to identify the modelling needs for the impact assessment in the LCIA context.

### 3. Methodology

A review of scientific articles and reports focusing on evidence of impact on pollinator populations and pollination services has been conducted using the bibliographic database SCOPUS and the 'ConservationEvidence.com' website, a free authoritative information resource designed to support global biodiversity. A preliminary search was performed using headings based on combinations of broader terms related to pollination issue ((pollinator\* OR pollination) AND (decline\* OR loss\* OR threat\* OR impact\* OR risk\*)), in order to enable an early understanding of the current forces exerting pressures on pollinator populations. Then, in order to limit the results to the explicit impact drivers showed off by the preliminary search, more detailed literature searches were conducted using relevant and logical keywords referring to the specific impact driving forces (e.g. (land OR habitat) AND (transformation\* OR degradation), 'chemical emissions'). The search outputs included reviews, laboratory- and field-based studies and scientific reports predominantly (>80%) from refereed journal manifesting clear impacts on pollinator communities and pollination service and also suggesting which indicators are currently adopted. Except two older papers, the publication years range from 2001 to date. Studies reporting no documentation on the effects which pollinators are subjected were excluded. A database was created to enable efficient grouping and subsequent analysis of these studies. Information including authors and publication date, brief paper description, impact driver categories, pollinator group affected, resulting effect in pollinators and their services, data type, modelling approach and indicators of impact and damage was recorded.

### 4. Results

We selected 95 published studies investigating different drivers involved in pollinator crisis. Of these, 25 were reviews (21 were monothematic, whereas the remaining four reviews had a more holistic approach), 12 scientific reports (six of them proceeding from European Agencies) and 58 research articles. The analysis of the scientific outputs revealed that the published research in this area has recently increased. The review led to the identification of eight impact drivers (Figure 1), namely: 1) intensified land use as a result of uncontrolled expansion of urban areas and modern agricultural practices; 2) use of pesticides; 3) global and local climate change; 4) introduction of alien plant; 5) competition with invasive pollinator species; 6) spread of pests and pathogens; 7) electro-magnetic fields and 8) genetically modified crops, recently identified as potential additional threats to insect pollinators [4].

Lately, research has been predominantly focused on 'land use' and the impacts derived from it on pollinator populations, with authors primarily interested in investigating the effects of habitat fragmentation as a consequence of agricultural intensification and cultivated crop expansion [5]. Pesticides, particularly systemic insecticides like neonicotinoids and invasive alien species represent the second most serious threat to pollinators, posing a risk to the biodiversity of pollinators [6, 7]. Bt-toxins contained in pollen and nectar of genetically modified crops and their effects on pollinators correspond to the least covered area. Bt-toxins may alter pollinator behaviour potentially limiting their visitations to flowering plants and consequently resulting in loss of pollination services [4]. Across all impact drivers, the majority of the reviewed papers tends to focus on honeybee species (*Apis mellifera* spp.), and to a lesser extent on bumblebees species (*Bombus* spp.). Among non-Hymenoptera pollinators, lepidopterans and dipterans resulted to be the most



investigated.

Despite the importance of pollinators for several aspects of the human well-being and for the maintenance of terrestrial biodiversity, the current LCIA framework incorporates only a reduced number of the above-mentioned threats (i.e. land use, ecotoxicity and climate change, see figure 1), whereas the others have not yet been included, although there is evidence of the pressure that they put on pollinators. Furthermore, current LCIA framework do not effectively account for the functional role of pollinators and pollination service, neither at the midpoint nor at endpoint level. Of course, the inclusion of pollinators may need to expand the elements currently covered by the area of protection “ecosystem quality”, checking whether current metrics such as potentially affected fraction of species (PAF) are suitable for expressing and then aggregating ecosystem-related results.

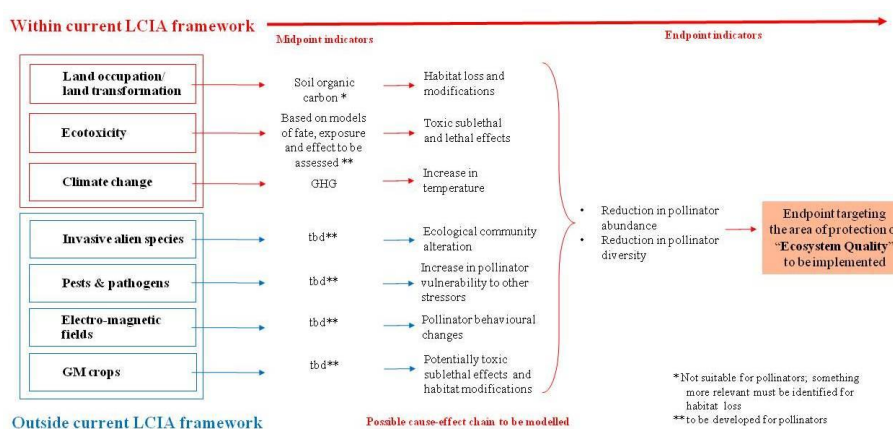

Figure 1: Identified drivers of impacts on pollinators; in some cases an impact category already exists within the traditional LCIA framework (red boxes), whereas in other cases new impact categories should be included (blue boxes). Reduction in provision of ecosystem services may lead to subsequent loss in the global economic system, nutrition supply and genetic resources

## 5. Conclusion

In this review, we showed that several authors have long recognized the main drivers of impact acting on pollinators, potentially threatening pollination services, which primarily derive from intensive agricultural practice. Notwithstanding the importance of pollination from environmental and socio-economic reasons, existing LCIA methods and models appear to be incomplete with respect to pollinators. This is principally due to a general lack of knowledge on how different anthropogenic pressures affect pollinators and pollination services, and on how species diversity is connected to ecosystem functioning and human well-being. Therefore, there are specific research needs towards the integration of pollinators as a target for protection in the LCIA framework. Firstly, future investigations are to be oriented to improve the models and the indicators currently used in the LCIA framework. Thus, it is of high priority integrating fate, exposure and effects of the chemicals affecting pollination in current models of ecotoxicity and the features which highlight the loss of relevant habitats to pollinators in the current land use models. Then, for other categories of impacts, novel models and indicators both at midpoint and endpoint levels should be developed in order to cover the existing conceptual and methodological gaps.

Particularly, new impact categories and related models should be developed and the feasibility of including them in the LCIA methodology should be assessed. Considering the role of crucial ecosystem services in human life and economic processes, this is an impelling step for increasing comprehensiveness of LCA. The services provided by pollinators are one important component of social well-being and economic stability worldwide, and accounting for them is fundamental in any effort that aims to enhance the sustainability of certain human activities.

## 6. References

- [1] MEA (Millennium Ecosystem Assessment) (2005) *Ecosystems and Human Well-being: Biodiversity Synthesis*. World Resources Institute, Washington, DC
- [2] Klein, A-M., Vaissière, B.E., Cane, J.H., Steffan-Dewenter, I., Cunningham, S.A., Kremen, C. and Tscharntke, T. (2007) Importance of pollinators in changing landscapes for world crops, *Proceedings of The Royal Society B* 274:303-313.
- [3] Vanbergen and the Insect Pollinators Initiative (2006) Threats to an ecosystem service: pressures on pollinators *Frontiers in Ecology and the Environment* 1:251–259.
- [4] Han, P., Niu, C.Y., Lei, C.L., Cui, J.J., Desneux, N. (2010) Quantification of toxins in a Cry1Ac+ CpTI cotton cultivar and its potential effects on the honey bee *Apis mellifera* L. *Ecotoxicology* 19(8):1452-1459.
- [5] Holzschuh, A., Dormann, C.F., Tscharntke, T, Steffan-Dewenter, I. (2011) Expansion of mass-flowering crops leads to transient pollinator dilution and reduced wild plant pollination, *Proceedings of the Royal Society of London B: Biological Sciences* rspb20110268.
- [6] Godfray, H.C.J., Blacquiere, T., Field, L.M., et al (2014) A restatement of the natural science evidence base concerning neonicotinoid insecticides and insect pollinators, *Proceedings of the Royal Society of London B: Biological Sciences* 281(1786) 20140558.
- [7] Aizen, M.A., Morales, C.L., Morales, J.M. (2008) Invasive mutualists erode native pollination webs. *PLoS biology* 6(2):0396-0403

# Evaluating use stage exposure to food contact materials in a LCA framework

Alexi Ernstoff<sup>1</sup>, Olivier Jolliet<sup>2</sup>, Peter Fantke<sup>1</sup>

<sup>1</sup>Quantitative Sustainability Assessment, Technical University of Denmark, Kgs. Lyngby, DK

<sup>2</sup>Environmental Health, University of Michigan, Ann Arbor, Michigan, USA

E-mail contact: [alexer@dtu.dk](mailto:alexer@dtu.dk)

## 1. Abstract

*We present novel methods to incorporate exposure to chemicals within food contact materials (FCM) (e.g. packaging) into life cycle impact assessment (LCIA). Chemical migration into food is modeled as a function of contact temperature, time, and various chemical, FCM, and food properties. In order to reduce computing time and complexity, a double exponential curve was fit ( $R^2 \approx 1$ ) to an exposure model which otherwise requires numeric solutions. The model is modified to evaluate the product intake fraction, PiF, which is a new metric that accounts for exposure to mass of chemicals embodied in a product in a way compatible with intake fraction, iF, a metric traditionally used in LCIA. The model predicts PiF increases with temperature and for compounds with lower octanol-water partition coefficients within more permeable materials which are in contact with foods with high ethanol equivalencies (fatty foods).*

## 2. Introduction

Various life cycle assessment (LCA) studies evaluating food contact materials (FCMs), like baby food packaging containers, have found advantages to plastic over glass [1]. Life cycle impact assessment (LCIA) includes human toxicity impacts from exposure to chemicals released throughout product life cycles, but excludes use stage exposures to chemicals migrating from FCM into food. Generally, regulatory risk assessments aim to ensure human exposure to potentially harmful chemicals in food is below certain thresholds of ‘safety’ and rely on submitted industry data or migration modeling of supposed worst-case scenarios [2]. Such efforts help limit dietary exposure, but actual human intake and levels of some phthalates within food nonetheless approach or exceed regulatory thresholds—with indication of FCMs as the chemicals source [3]. Furthermore, regulatory thresholds for toxic substances are continuously subject to change for various reasons and differ between countries [4, 5]. Unlike risk assessment the primary goal of LCIA is not to ensure individual consumer safety with respects to toxicity thresholds, but to indicate products with minimal potential for population-scale impact, and thus LCIA methods rely on linear dose-response relationships (not thresholds) derived from toxicity studies and combine these with average population-scale (not worst-case individual) exposure. Accordingly, LCIA is a promising risk-minimization and product-optimization approach for FCM; however, methods to include exposure to FCM in LCIA are currently lacking although they likely exceed other life cycle exposures [3]. Our goal is to provide LCIA-compatible methods to close this research gap.

## 3. Methods

To be compatible with the scope of LCIA, which defines a reference flow (e.g. a mass of packaging required to contain a volume of food), we built the FCM exposure model to estimate the newly defined product intake fraction, PiF ( $\text{kg}_{\text{intake}}/\text{kg}_{\text{in product}}$ ) [6]. This method quantifies PiF as the chemical-specific mass taken in by users of the FCM product per kilo of chemical in the FCM—where ingestion is assumed to be the

dominating route, and food waste, inhalation, dermal contact, and exposure to environmental emissions are assumed negligible.

	Parameter		Parameter		Parameter
a	octanol-water partition coefficient, $K_{ow}$	b	root of $\tan q_n = -\alpha q_n$	c	volume of FCM
a	molecular weight, MW	c	initial concentration (migrant)	c	density of FCM
b	diffusion coefficient (migrant)	c	temperature	c	thickness of FCM
b	diffusion parameter (polymer)	c	time of contact	c	density of food
b	ethanol equivalency of food, E-eq	c	activation energy (polymer)	c	mass of food
b	package-food partition coefficient, $K_{p,F}$	c	contact area	c	volume of food

Table 1: Required parameters for migration model, and their classification a, b, or c

We adapted a numeric migration model commonly used in regulatory risk assessment and compliance testing [7, 8, 10], by deriving an analytical solution and providing average/realistic diffusion and partition coefficients for use in LCIA, instead of the default values used by risk assessors. Specifically, the model is for chemicals in plastic packaging (see [8]) relying on 19 input parameters (Table 1) which we classified as a) *available* in open-source platforms (e.g. molecular weight), b) *estimable* (e.g. by a linear regression), and c) *default assumptions* given by regulatory documents [8] which can be updated by the LCA practitioner. The model was programmed in MATLAB<sup>®</sup> and we developed approximation strategies when needed, e.g. the plastic-food partition coefficient ( $K_{p,F}$ ) is a function of ethanol-equivalency (e.g. food fat content) and the octanol-water partition coefficient ( $K_{ow}$ ) of the chemical migrant [9]. We also extracted data from [8] to calculate average polymer-specific diffusion parameters. Further, we investigated fitting a double exponential to the model:  $PiF(kg_{intake}/kg_{in\ product}) = a * \exp(b * t) + c * \exp(d * t)$  which could then be programmed in a spreadsheet where computing time and required input parameters are reduced.

Hypothetical migrants across  $K_{ow}$  and at two molecular weights (MW) within polyethylene terephthalate (PET) were modeled at 5°C for 10 days. PiF was also modeled for diethylhexyl phthalate (DEHP) in PET and high-density polyethylene (HDPE) as FCMs for milk, clear drinks, and dough (spanning ethanol equivalencies), at 125°C for in-bottle pasteurization.

#### 4. Results and Discussion

We used a regulatory risk assessment FCM migration model, and derived a nearly identical but analytically computational solution, solved for the LCIA-compatible PiF metric, and estimated average (not worst-case) diffusion and partition coefficients. Our results and work by [7,8,9,10] identify  $K_{p,F}$  as an important parameter. We developed a linear approximation for  $K_{p,F}$  for all ethanol equivalencies (E-eq) i.e. content of organic phase, such as fat within foods, from data available in [9] for only three E-eq. More data may be needed for an improved approximation, e.g. as provided in background calculations in FACET [10]. When regulators apply the migration model [8] parameters classified as b) *estimatable*, are often set to a fixed value. Although stated in regulatory documents that package-food partition coefficient,  $K_{p,F}=1$  is a fixed “worst-case,” we found evidence  $K_{p,F}<1$  may occur experimentally [9], and that conveniently, when  $K_{p,F}=1$

dependent parameters are also fixed, simplifying the calculation. For various plastic-food combinations we found often  $K_{p,F} > 1$ , which supports the need to better approximate  $K_{p,F}$  for model application in LCIA as well as for realistic exposure estimates [10].

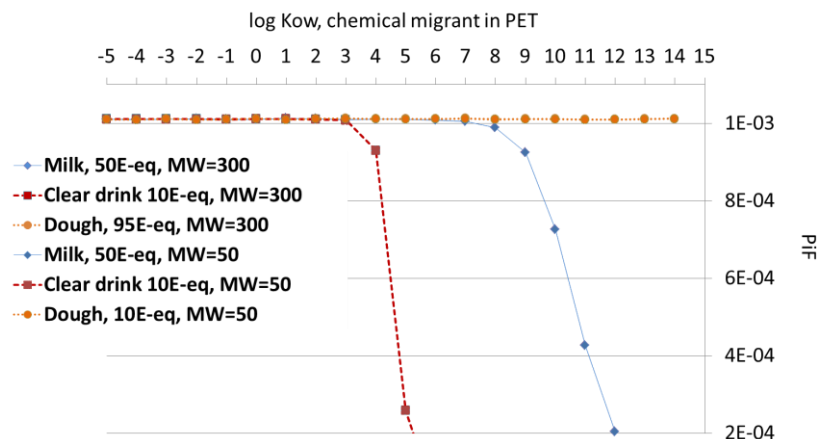

Figure 1: PiF model results across  $K_{ow}$  for hypothetical migrants at MW=300 and 50 g/mol, for foods with various ethanol equivalencies (E-eq).

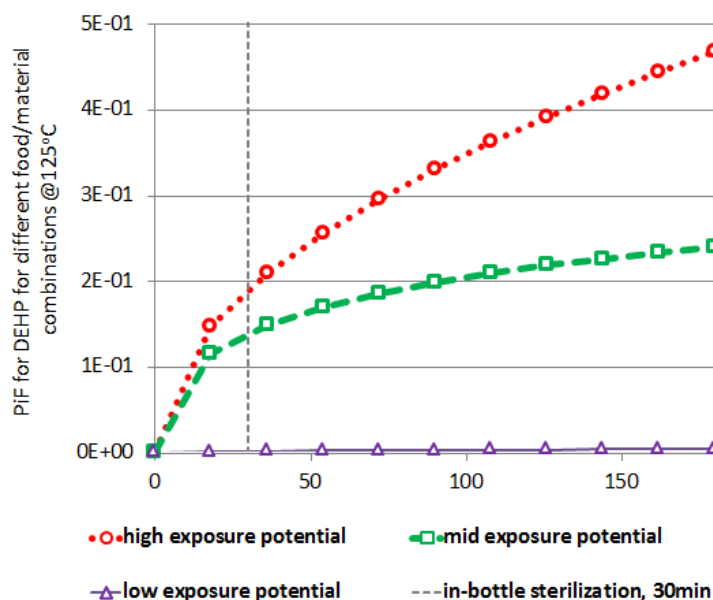

Figure 2: Example of the PiF model results for DEHP, where exposure potential was found to be high for DEHP in HDPE for foods with 90%E-eq, mid for HPDE for foods with 50%E-eq, and low for DEHP in PET with all food types as well as HPDE with 10%E-eq.

Further, via MATLAB<sup>®</sup> we fit and parameterized a double exponential curve ( $R^2 \approx 1$ ), where for example parameter  $c=1-a$ , and  $a, b, d$  are functions of easily obtainable input parameters. In this manner, the difficult to obtain input parameters, e.g. iterative solutions of transcendental equations, were no longer needed and computational time was decreased.

Preliminary results, e.g. for PET demonstrate that when contact temperature,  $T=5^\circ\text{C}$ ,  $\text{PiF} < 10^{-3} \text{ kg}_{\text{intake}}/\text{kg}_{\text{in product}}$  and is largely influenced by  $K_{p,F}$  which is a function of  $K_{ow}$  of the migrant and E-eq of the contacted (packaged) food. This reflects that chemicals tend to remain partitioned in plastic when in contact with foods with low ethanol-equivalencies (e.g. clear drinks), but increasingly partition into foods with higher ethanol

equivalencies (e.g. milk and dough) (Figure 1). A migrant's MW was unimportant for the  $T=5^{\circ}\text{C}$  scenarios (Figure 1), but has a major influence at  $T=125^{\circ}\text{C}$  for in-bottle pasteurization (results not shown) because of the influence of the diffusion coefficient. For high temperatures, PiF can approach 20% for contact times of 30 minutes (Figure 2) for foods with high ethanol equivalencies (e.g. >90%) when the model was run for DEHP within FCM made of HDPE (which is typically not legally allowed, however may occur at low levels via recycling processes and/or contamination). As our model is based on a regulatory model, the trends we observed with respect to chemical, food, material, and scenario properties are also considered by risk assessors, e.g. reduction factors for certain fatty foods are applied assuming that modeling with a high E-eq greatly overestimates exposure [2].

## 5. Conclusion

We developed a modeling strategy that adapts and parameterizes a numerical FCM migration model normally used to ensure risk-based regulatory compliance, to be operational in LCIA by analytically estimating an average/realistic PiF. While risk assessment based on supposed worst-case scenarios is required to evaluate FCM safety compliance, including FCM migration modeling in LCIA has a different goal of comparative risk minimization which accounts for impact trade-offs due to the entire FCM life cycle. Including use stage exposures to FCM in LCIA—which judging by preliminary calculation of PiFs has the potential for exposure exceeding environmentally mediated exposures by orders of magnitude—may help minimize exposure to chemicals within FCM, which is especially important for those which already exceed regulatory statutes, like DEHP, and may be due to recycling or other processes along the products' life cycles.

## 6. References

- [1] Humbert, S., Rossi, V., Margni, M., Jolliet, O. and Loerincik, Y., 'Life cycle assessment of two baby food packaging alternatives: glass jars vs. plastic pots' *Int J Life Cycle Assess* 14 (2) (2009) 95–106.
- [2] Simoneau, C. Applicability of generally recognised diffusion models for the estimation of specific migration in support of EU Directive 2002/72/EC. European Commission, JRC (2010).
- [3] Lee, J., Pedersen, A. B. and Thomsen, M., 'The influence of resource strategies on childhood phthalate exposure – The role of REACH in a zero waste society' *Environ. Int.* 73 (2014) 312–322.
- [4] Magnuson, B., Munro, I., Abbot, P., Baldwin, N., Lopez-Garcia, R., Ly, K., McGirr, L., Roberts, A. and Socolovsky, S., 'Review of the regulation and safety assessment of food substances in various countries and jurisdictions' *Food Addit Contam Part A Chem Anal Control Expo Risk Assess.* 30 (7) (2013) 1147–1220.
- [5] Muncke, J., Myers, J. P., Scheringer, M. and Porta, M., 'Food packaging and migration of food contact materials: will epidemiologists rise to the neotoxic challenge?' *J Epidemiol Community Health* (2013).
- [6] Jolliet, O., Ernstoff, A., Csiszar, S. and Fantke, P., 'Defining the Product Intake Fraction to Quantify and Compare Exposure to Consumer Products'. *Environ Sci and Technol* (in press, doi: 10.1021/acs.est.5b01083).
- [7] Begley, T., Castle, L., Feigenbaum, A., Franz, R., Hinrichs, K., Lickly, T., Mercea, P., Milana, M., O'Brien, A., Rebre, S. and et al., 'Evaluation of migration models that might be used in support of regulations for food-contact plastics' *Food Additives & Contaminants* 22 (1) (2005) 73–90.
- [8] Ozak, A., Gruner, A., Störmer, A., Brandsch, R., and Franz, R., 'Correlation between Partition Coefficients Polymer/Food Simulant, KP,F, and Octanol/Water, Log POW — a New Approach in support of Migration Modeling and Compliance Testing' *Deutsche Lebensmittel-Rundschau* 106 (4) (2010) 203–208.
- [9] Oldring, P. K. T., Castle, L., O'Mahony, C., Dixon, J., 'Estimates of Dietary Exposure to Bisphenol A (BPA) from Light Metal Packaging using Food Consumption and Packaging usage Data: A Refined Deterministic Approach and a Fully Probabilistic (FACET) Approach' *Food Addit Contam Part A Chem Anal Control Expo Risk Assess.* 31 (3) (2014) 466–489.

# Assessing freshwater biodiversity as endpoint modeling of impacts in LCIA: case of run-of-river hydropower

Joane Cettier<sup>1</sup>, Jérôme Payet<sup>2</sup>

<sup>1</sup>Cycleco, 18 Avenue Roger Salengro, 01500 Ambérieu-en-Bugey, France

<sup>2</sup>IES, Ecole Polytechnique Fédérale de Lausanne, DGR-EPFL 1015 Lausanne, Switzerland

E-mail contact: [joane.cettier@cycleco.eu](mailto:joane.cettier@cycleco.eu)

## 1. Abstract

A run-of-river (ROR) hydropower runs without water storage and uses the river flow. But it decreases the river flow and the river velocity, downstream and upstream the weir respectively and the substrate of the river can be affected. These physical impacts result in a lower community density, biomass and modify the population of macroinvertebrates and fishes.

In this context, the aim is to develop new characterization factors (CF) for presence/absence of the freshwater species biodiversity in Life Cycle Assessment (LCA) of a ROR hydropower.

The methodology is based on a database of 498 species with their preference score for substrate. For a change of substrate, a status is defined for each species: non-affected (NA), affected (A) or disappeared (D). Biodiversity impacts CFs of a ROR hydropower were known for 1 kWh produced by the plant in  $PDF.m^2.year/kWh$  and  $PAF.m^2.year/kWh$ .

## 2. Introduction

A run-of-river (ROR) hydropower runs without water storage and uses the river flow. Channel weirs regulate water levels, allowing a proportion of the flow to be diverted down a secondary channel to a turbine, before it returns to the main channel further downstream. Relatively large volumes of water are diverted, for a distance between diversion and return, which is tens to hundreds of meters. Moreover, the raised water levels upstream of weirs reduce the flow variability, the velocity and the turbulence and induce fine sediment deposition. These environment changes induce a lower biodiversity and a populations difference of macroinvertebrates and fishes [1]. The definition of biodiversity includes all levels, from genetics to population. In our case, biodiversity solely takes into account the presence/absence of different aquatic macroinvertebrates and fishes in freshwater.

Physical, and consequently, ecological impacts of a ROR hydropower are investigated thanks to previous studies, but remain sparse. To determine the biodiversity impacts of a ROR hydropower, we wished to identify the changes in biodiversity according to changes of flow and velocity of the river. The objective is to create new characterization factors (CF) for Life Cycle Assessment (LCA) that addresses the biodiversity that is affected and disappeared due to a running ROR hydropower.

## 3. Materials and methods

### 3.1 Non affected, affected and disappeared status attribution

The CFs' development started with a literature search in order to identify the natural parameters of a river without a ROR hydropower. For each upstream to downstream river profile, physical parameters like speed, slope, and substrate type were searched for. Several databases which determine the preference/affinity of a

species with a physical parameter were found. The Tachet's database for invertebrates including 472 macroinvertebrates [2] and IRSTEA's (Institut National de Recherche en Sciences et Technologies pour l'Environnement et l'Agriculture) information including 26 preferences fish curves were used. To build these curves, fishes were identified and measured in 50 m<sup>2</sup> area of the river for which substrate, velocity and depth were identified. The log-density value obtained during this sampling can be interpreted as habitat preference curve [3]. An example of each database is provided Table 1 and Figure 1.

Genus	Species	flags/boulders/cobbles/pebbles	gravel	sand	silt
Spongilla	lacustris	4	2	0	0
Trochospongilla	horrida	3	0	0	0
Heteromyenia	baileyi	3	0	0	0

Table 1: Extract of the Tachet's database

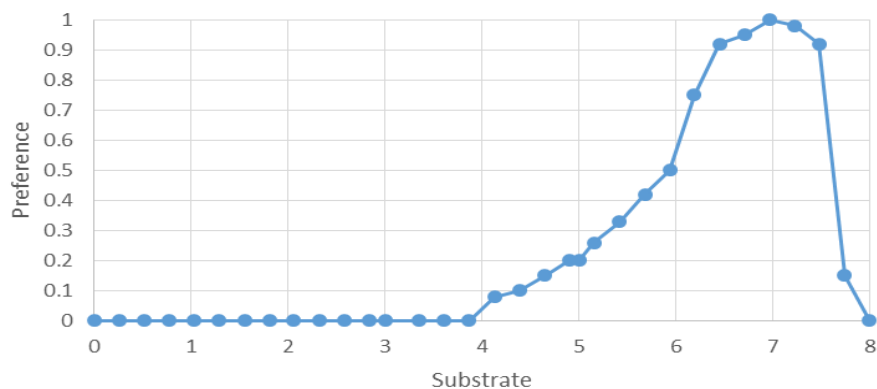

Figure 1: Salmon preference for the river substrate (0: litter to 8: flags)

These two databases generated a new affinity database of 498 species with preferences converted into scores on a scale of 0 (no affinity) to 5 (very strong affinity) for eight classes of substrate (flags, boulders, cobbles, pebbles, gravels, sand, silt and litter). The type of river (Epi-, méta- and hypo-; crenon, rithron and potamon) and the geographic affinity (Alps, Pyrenees, Vosges/Jura/Massif Central, Mediterranean lowland and Oceanic lowland) are also available in the database. For each decrease of grain size class, the affinity score could change. If the score is better when passing through a lower grain size class, the species is considered non-affected (NA). If the score is worse when passing through a lower class other than 0, the species is considered affected (A), otherwise the species is considered disappeared (D). At the end, the percentage of NA, A and D in the population is known for each substrate's class diminution. The number of NA, A and D for each substrate's class diminution according to the river type is presented for the Alps in Figure 2. This database is considered to include data coming from several temporal and geographical samplings. The seasonality is not taken into account and the data provided is supposed to present annual average affinity.



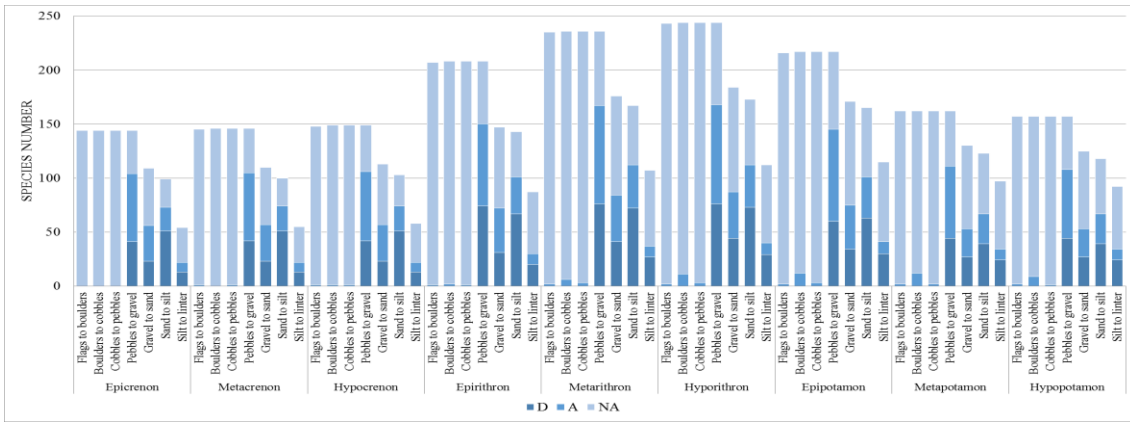

Figure 2: Number of NA, A and D species for a substrate class diminution according to the river type in the Alps

### 3.2 Characterization Factors' calculation

The CFs are calculated for one geographic location and one river type. Information originating from nine ROR hydropower plants in France is available. For each flow or velocity decrease, a substrate variation is associated. Upstream the weir, the finest particules in suspension settle and the initial substrate changes to litter. Downstream the weir, the flow decreasing induces a reduction of the shear force and thus a reduction of the granulometry deposited in the river bed. Thanks to the substrate type curves according to the slope and the flow for a mean cross section (average of the cross section of the river before and after the water was diverted), the change of granulometry can be determined as presented in Figure 3

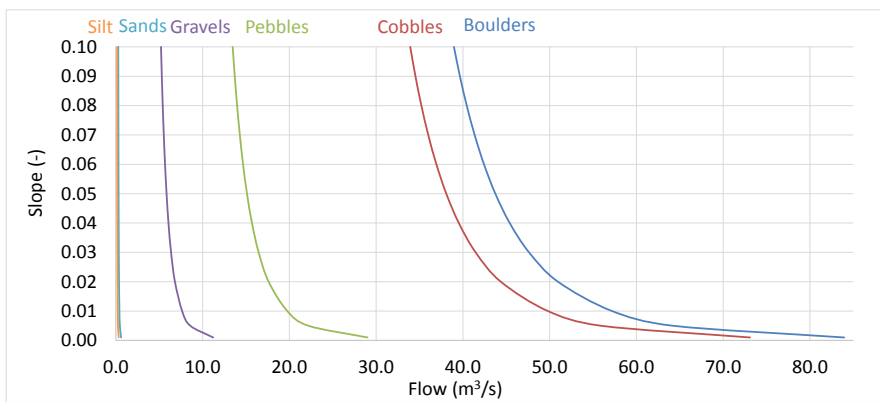

Figure 3: Granulometry curves according to the slope and the flow for a mean cross section of 11.7 m<sup>2</sup>

For each granulometry variation, the percentage of affected or disappeared species is known. For the riverbed exposure, it is considered that 100% of the species are disappeared in this surface without water. The Potential Affected Fraction (number (D+A)/initial population) and the Potential Disappeared Fraction (number D/initial population) are integrated over time and space. Time is 100 years of running of the ROR hydropower and space is the fraction upstream affected by velocity decrease, the fraction downstream affected by flow decrease or the surface of riverbed exposed in m<sup>2</sup>. In order to establish a link between this impact and the production of the ROR hydropower, the impact is divided by the production in kWh for 100 years. Finally, the impacts on biodiversity of a ROR hydropower are calculated in PDF or PAF.m<sup>2</sup>.year/kWh and for the global freshwater compartment. When several plants were implemented in the same river type and geographic location, results were averaged geometrically.

#### 4. Results

The new ROR hydropower impact on biodiversity CFs are presented in Table 2 for different river types and geographic locations.

Geographic location	River type	Flow loss		Velocity loss		Riverbed exposure
		PAF.m <sup>2</sup> .year/k Wh	PDF.m <sup>2</sup> .year/k Wh	PAF.m <sup>2</sup> .year/k Wh	PDF.m <sup>2</sup> .year/k Wh	PDF.m <sup>2</sup> .year/k Wh
Vosges/Jura/Massif Central	Hyporithron	4.06E-10	1.96E-10	1.57E-12	8.99E-11	3.71E-13
Vosges/Jura/Massif Central	Hypocrénon	1.32E-11	5.28E-12	3.78E-11	1.96E-11	5.44E-14
Vosges/Jura/Massif Central	Epipotamon	NA	NA	3.35E-11	1.94E-11	NA
Alps	Metarithron	NA	NA	1.46E-09	8.40E-10	NA
Oceanic lowland	Epipotamon	2.01E-07	1.59E-07	2.33E-09	1.35E-09	2.95E-12

Table 2: CFs for ROR hydropower plants for the 3 impacts identified in the river for the global freshwater compartment. NA: Not applicable

#### 5. Discussion and conclusion

To date, there are more ROR hydropower plants in France than dams for which impacts are well known. ROR hydropowers were thought to have no impact on the river biodiversity because there is no water storage. In LCA, this impact is lacking whereas literature shows it. Thanks to this innovative work, it is now possible to determine the biodiversity impacts of ROR hydropowers in LCA. Nevertheless, these CFs were calculated using a limited number of data collected in plants and should be completed with new data.

#### 6. References

- [1] D. Anderson, H. Moggridge, P. Warren, J. Shucksmith, The impacts of “run-of-river” hydropower on the physical and ecological condition of rivers: Physical and ecological impacts of ROR hydropower, *Water and Environment Journal*. (2014) 1–11. doi:10.1111/wej.12101
- [2] H. Tachet, M. Bournaud, P. Richoux, P. Usseglio-Polatera, *Invertébrés d’eau douce : Systématique, biologie, écologie*, CNRS Editions, Paris, 2000.
- [3] N. Lamouroux, H. Capra, M. Pouilly, Y. Souchon, Fish habitat preferences in large streams of southern France, *Freshwater Biology*. 42 (1999) 673–687. doi:10.1046/j.1365-2427.1999.00521.x.

# **Spatial and temporal assessment of GHG emissions from cocoa farming in the region of San Martin, Peru**

*Giancarlo, Raschio; Sergiy, Smetana; Mathys, Alexander; Heinz, Volker*

*German Institute of Food Technologies (DIL e.V.), Prof.-von-Klitzing-Str. 7,D - 49610 Quakenbrück, Germany*

*E-mail contact: g.raschio@dil-ev.de*

## **1. Abstract**

*Companies in the agri-food sector managing greenhouse gasses (GHG) emissions from their supply chains need site-specific impact analysis that incorporate important factors such as the spatial distribution of GHG, specific transportation distance and deforestation at farm level as variations of these factors alter environmental impact dramatically. Incorporating spatial and temporal factors into Life Cycle Assessment (LCA) is possible by coupling this tool with Geographic Information Systems (GIS). This paper applies LCA and GIS to explore spatial and temporal distribution of GHG emission from cocoa farming, complementary shade crop (banana) and the associated deforestation from implementing new cocoa farms. Results show that in any year deforestation accounts for more than 90% of total GHG and cocoa farms with higher than average GHG emissions tend to locate no farther than 40km from the marketplace.*

## **2. Introduction**

Businesses purchase agri-food products from particular regions in a country, not from all producing areas in a country at once. Also, impacts from farming depend on their location and vary over time [1]. These facts also apply to the chocolate industry, which in addition faces key challenges in its supply of cocoa such as poor road infrastructure, spatial distribution of farms and deforestation. These issues must be addressed by accounting for spatial variables over time. Therefore, companies using LCA to identify impacts in their supply chains need to incorporate spatial and temporal analytics in their analysis.

LCA is a tool that identifies environmental impacts throughout the lifecycle of products and services by using country-level or global average information and taking a snapshot in time of the process, a fact that in many cases do not reflect on-the-ground reality [2].

Although there are only a few LCA studies on cocoa and chocolate, these do not account either for the spatial variability of farms, temporal variations of input requirements nor GHG emissions from the production of complementary shade crops such as banana [3][4]. Also, these studies identify cocoa farming to have the lowest contribution on overall GHG emissions from chocolate production, most likely because they don't account for the deforestation incurred when implementing some of the farms.

Therefore, there is a need to include spatial and temporal analytics into LCA studies. Geographic Information Systems (GIS) tools can complement LCA studies in accounting for spatio-temporal environmental impacts. The focus of this study is limited to GHG, and it does not consider crucial impacts such as those on water resources and land-use change (i.e. Biodiversity loss). This study explores how LCA and GIS can complement each other to identify spatio-temporal variations of GHG, taking as a case study cocoa farming in the region of San Martin region in Peru.

### 3. Methods

We used data on cocoa farms from a census conducted by DEVIDA (National Commission for Development and Life Without Drugs) in the Tocache province, region of San Martin in Peru in 2011 (Figure 1) [5]. The census included farms of different age (implemented between 2006 and 2010) and at different production stages.

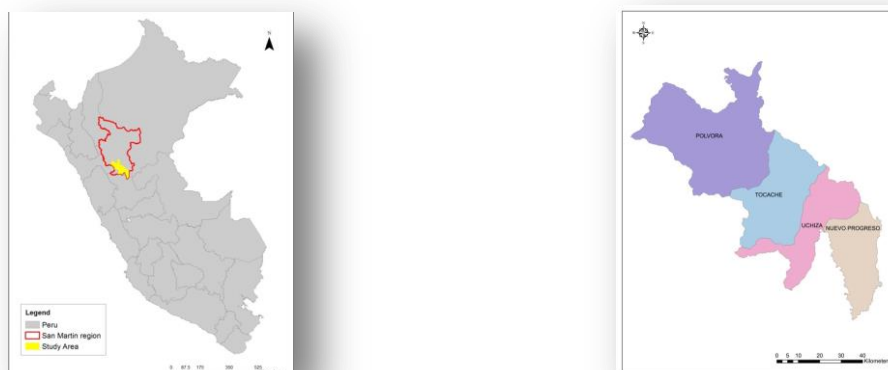

Figure 1 : location of the study area, Peru (left) and Tocache province (right)

We calculated global warming impact potential GWP100 (tCO<sub>2</sub>eq) for each of the first five years of a cocoa farm in the region using as a reference unit 1ha (all the data collected by the census was in terms of inputs used for 1ha) using OpenLCA, NREL US inventory data and IPCC2004 methodology.

Cocoa farms in the study area use banana as shade crops. Therefore, banana had to be accounted for as a complementary produce; allocation between the two crops was done by mass. In the first two years, there is not cocoa production (young trees) but only banana production. In the third year there is both banana and cocoa production. From the fourth years onwards there is only cocoa production. Allocation between bananas and cocoa was applied to the GWP100 results by applying factors of 0.1 and 0.9, for banana and cocoa respectively. GWP100 results were then exported as a shapefile into a GIS system.

#### 3.1 Transportation GHG

Using GIS and a shapefile of roads network, we calculated distances from each farm to the closest road and then from the roads to the market place. An emission factor was then applied to calculate GHG from transportation based on distance and weight of products transported from each farm to the marketplace each year. GHG for the third year of each farm had to be allocated between the load of cocoa and bananas transported that year using the same factors used to allocate GWP100. We based allocation on a mass (weight) basis.

#### 3.2 Deforestation GHG

In their first year, some farms cause deforestation when implemented. We estimated deforestation (in hectares) for each farm by overlapping them with a forest cover layer for 2011. If in 2011 an area is classified as forest but based on the census data we know that a cocoa farm exists in that given area, then we can assume that such farm has caused deforestation when it was implemented.

To calculate GHG from deforestation we used IPCC's values of GHG for tropical forests (augmented in 75% to account for uncertainty) and for cropland (reduced in 75% to account for uncertainty) [6].

We conducted allocation of deforestation among the first three years of production. Given the fact that deforestation occurs in the first year of the farms when no cocoa is produced, allocation was necessary to equally distribute deforestation GHG among the first three years of production. We did not consider allocating deforestation GHG throughout the productive lifetime of cocoa farms (about 25 years) because that would have reduced the perceived impact of deforestation and could constitute a negative incentive for companies sourcing cocoa in the area.

### *3.3 GHG for production years*

We calculated GHG for the years 2008- 2010 accounting for 155 farms in 2008, 909 farms in 2009 and 1,187 farms in 2010, all producing cocoa at different growing stages (first to third production years). Calculations were made to account only for cocoa production (farming and transportation) and deforestation (farming, transportation and deforestation). Finally, we used spatial statistics to conduct grouping analysis to farms producing cocoa in 2008-2010. The variables used were total distance to the marketplace and GHG emissions from cocoa production for the given year.

## **4. Results**

- Over time, farms with 50% or more GHG than the regional average tend to locate farther from the marketplace, but no farther than 40km in any case;
- Over time, farms with 30% or less GHG than the regional average tend consistently concentrate between 50km and 95km from the marketplace;
- Farms with lower than average GHG emissions from cocoa production tend to be located farther than 50km from the marketplace but no farther than 95km;
- Considering only cocoa production (no banana production or deforestation), in any given year farming accounts on average for 97% of the total GHG emissions whereas transportation for 3%;
- Considering only banana production (no cocoa production or deforestation), in any given year farming accounts on average for 45% of the total GHG whereas transportation for 55%;
- Considering cocoa production and associated deforestation (no banana production), in any given year deforestation accounts on average for more than 90% of the total GHG; in the years 2008 and 2009 GHG emissions from deforestation accounted for more than 98% of the total emissions .

## **5. Conclusions**

- For the study period of 2006-2010, GHG emissions from deforestation were on average 33 times as much as those from cocoa production (being up to 68 times in 2008) even though GHG emissions from deforestation increased on average 17% per year whereas GHG emissions from cocoa production (farming and transportation) increased on average 261% per year.
- Spatio-temporal analysis is key to understand how the different processes required for cocoa production (i.e. deforestation, banana growing, transportation, different production levels) contribute to overall GHG emissions.

## 5. References

- [1] Schaltegger, Stefan. "Economics of life cycle assessment: inefficiency of the present approach." *Business Strategy and the Environment* 6.1 (1997): 1-8.
- [2] Mutel, Christopher L., and Stefanie Hellweg. "Regionalized life cycle assessment: computational methodology and application to inventory databases." *Environmental science & technology* 43.15 (2009): 5797-5803.
- [3] Bessou, Cécile, et al. "LCA applied to perennial cropping systems: a review focused on the farm stage." *The International Journal of Life Cycle Assessment* 18.2 (2013): 340-361.
- [4] Ntiamoah, Augustine, and George Afrane. "Environmental impacts of cocoa production and processing in Ghana: life cycle assessment approach." *Journal of Cleaner Production* 16.16 (2008): 1735-1740.
- [5] DEVIDA. *Alternative crops monitoring 2011-2012*. DEVIDA's Alternative Development Project. (2011).
- [6] Intergovernmental Panel on Climate Change (IPCC). "Good practice guidance for land use, land-use change and forestry." Table 3A.2-Table 3.3.8. (2003).

# Land use in life cycle impact assessment: a review of models at midpoint level to incorporate impacts on soil state and functioning

*Vidal-Legaz B<sup>1</sup>, Sala S<sup>1</sup>, Anton A<sup>2</sup>, Teixeira R<sup>3</sup>, Maia de Souza D<sup>4</sup>, Michelsen O<sup>5</sup>, Putman B<sup>6</sup>*

<sup>1</sup>*European Commission, Joint Research Centre, Institute for Environment and Sustainability, Ispra, Italy*

<sup>2</sup>*Institute for Food and Agricultural Research and Technology, IRTA, Cabrils, Barcelona, Spain*

<sup>3</sup>*University of Antwerp, Research Group of Plant and Vegetation Ecology, Wilrijk, Belgium*

<sup>4</sup>*Swedish University of Agricultural Sciences, Uppsala, Sweden*

<sup>5</sup>*Institute of Environmental Engineering, ETH Zurich, Zurich, Switzerland*

<sup>6</sup>*University of Arkansas, Department Biological & Agricultural Engineering, Fayetteville, Arkansas, USA*

*E-mail contact: [beatriz.vidal-legaz@jrc.ec.europa.eu](mailto:beatriz.vidal-legaz@jrc.ec.europa.eu)*

## 1. Abstract

*In the context of life cycle impact assessment, the evaluation of land use impacts needs to be inclusive, incorporating models that allow the quantification of the impact of land use on soil. Soil is a key compartment, determining the supply of ecosystem services as well as supporting biodiversity. The present study reviews and compares a set of models for relating land occupation and land transformation to soil indicators at midpoint level, addressing soil properties and functions as well as threats to soil. Based on a systematic evaluation of available models, considering among other aspects their scientific soundness and ease of applicability for LCA practitioners, this work highlights their strengths and limitations. This allows identifying valuable approaches and research needs for improving the assessment of land use impact on soil in an LCA.*

## 2. Introduction

In recent years, more comprehensive approaches have been adopted for the Life Cycle Impact Assessment (LCIA) of land interventions. The land use impact pathway has been updated and new models have been incorporated, mostly addressing biodiversity loss (Koellner et al., 2013). Yet, the assessment of land use should be more inclusive, incorporating models that allow the quantification of the impact of land use on soil, as it determines the supply of ecosystem services –supporting, regulating, and provisioning services– as well as supports biodiversity. Thus, land use characterization models should cover indicators on soil properties, its functions, and threats, all of them typically covering a midpoint level of the impact pathway. The present study reviews and compares a set of models for relating land occupation and land transformation to soil indicators at midpoint level, addressing soil properties and functions and/or threats to soil. A systematic evaluation has been conducted, which identifies the strengths and limitations of the reviewed models, and highlights valuable impact characterization models.

## 3. Material and methods

Based on a systematic literature review, land use models were selected for evaluation, fulfilling minimum requirements: (i) having indicators for assessing soil properties, functions and/or threats; (ii) being at least to some extent compatible with LCA; (iii) availability or enabling calculation of characterization factors (CFs). Selected models were evaluated using an updated version of the International Life Cycle Data System (ILCD) handbook [1] set of criteria. The criteria focus on: (i) completeness of the scope, (ii) environmental

relevance, (iii) scientific robustness & uncertainty, (iv) documentation, transparency & reproducibility, (v) applicability and (vi) stakeholders' acceptance.

Based on the review, the land use impact pathway was revisited including the last developments [2-5]. This impact pathway was used as reference cause-effect chain during the models' evaluation and includes the functions/properties of and threats to soil, which belong to a midpoint level, and their link to endpoint indicators and the Areas of Protection (AoPs).

## 4. Results

### 4.1 Models for evaluation

A total of 11 models were pre-selected among those resulting from our literature review:

- Brandão & Milà i Canals 2013 [6], is an update of the model currently recommended in the ILCD handbook, using Soil Organic Carbon (SOC) as stand-alone soil quality indicator. The update model has CFs for the world.

- LANCA [7] and SALCA-SQ [9], and an application of LANCA, Saad et al. (2013) [8] as soil properties/function models. LANCA calculates the functions the soil can provide under different land uses and management practices. SALCA-SQ, similarly to LANCA, focuses on soil properties and threats to soil. Both LANCA and SALCA-SQ require complete, site-specific inventory data, including also land management practices and miss ready applicable CFs to elementary flows. Saad et al. (2013) develops a global application of LANCA, including some methodological modifications, e.g. it uses land use inventory flows directly and the provision of spatially differentiated CFs.

- model related to soil threats: Nuñez et al. (2010) [10], calculates a desertification index based on aridity, erosion, aquifer over-exploitation and fire risk. Garrigues et al. (2013) [11] focuses on soil compaction as a result of the use of agricultural machinery and calculates auxiliary indicators i.e. water erosion and SOM change. Nuñez et al. (2013) [12], computes the loss of Net Primary Production (NPP) and emergy as indicators of damage on ecosystems and resources, respectively. The three models show limitations regarding the availability of CFs: while CFs [10] and [12] requires specific LCI flows, CFs for [11] are not detailed in the study.

- models on ecosystem thermodynamics: exergy by Alvarenga et al. (2013) [13], and Human Appropriation of Primary Production (HANPP) by Alvarenga et al. (2015) [14]. [13] computes exergy in a differential way for natural and human-made land: exergy of biomass extracted is calculated for natural land, while the exergy associated to NPP is used for human-made land. Both models provide CFs associated with land use flows.

- models not specifically linked to LCA based on spatial datasets, Gardi et al. (2013) [15] and Burkhard et al. (2012) [16]. [15] presents a composite indicator on pressures to soil biodiversity including land use-related data (agriculture intensity, land use change), threats to soil (compaction, erosion, contamination, SOC loss), and threats to biodiversity (invasive species). [16] calculates indicators on ecosystem integrity and ecosystem services –provisioning, regulating and cultural– directly associated to land use –based on expert judgment for several case studies. Among the ecosystem services indicators, the model includes soil functions indicators (erosion regulation, water purification), endpoint indicators (water provision). Among the ecological



integrity indicators, it includes soil functions (SOC storage), and endpoint indicators (biodiversity, exergy capture).

#### 4.2 Model evaluation results and outlook

The models evaluated were overall complete in terms of having a consistent link to endpoint indicators and closeness to inventory data, except for [11] and [9]. As for the geographic coverage, models [9], [15] and [16] did not have a global geographic coverage, as they are based on site-specific data. Among the environmental relevance criteria, three models stand out, [6], [13] and [14], which provide different CFs values for different land use types. The coverage of ILCD elementary flows is low overall, with the exception of [14]. Only [6] and [8] compute the impact of both occupation and transformation according to the consensus method –transformation impact computed as area times quality change, considering also the recovery/restoration time, and occupation impact as area times quality change times occupation time. And only two models –[7] and [14]– were able to distinguish between extensive and intensive land uses.

Models showed to be scientifically robust overall. All models have been peer reviewed, stated their value choices –although generally an explicit, complete list of them was not reported. On the other hand, only three models, [11], [14] and [15] are up-to-date, being the remaining models only partially up-to-date, since they do not integrate the latest model developments in their respective fields. Most LCA models have conducted case studies, but none reported to be ready-to-use for products relevant in the market.

As for uncertainty assessment, only the model by [15] explicitly states to have undergone input data quality tests and uncertainty assessment.

The overall CFs availability, applicability and replicability is relatively low. As for LCI data, models have the required LCI flows available overall, although for many cases those do not correspond to the ILCD land use inventory flows and considerable efforts for mapping may be needed. Inventory data for [9], [10], [12] and [15]– are only partially available, requiring site specific processing of spatial data. Comprehensiveness was also challenged by some models mostly due to the limited coverage of flows by the impact assessment, e.g. models only addressing agricultural activities/land use types, e.g. [9], and [11], which might pose a bias in the land use impact assessment by these models. In conclusion, several valuable approaches appear for addressing the impact of land use on soil in a LCA context, including also two models not coming from the LCA community. However, further analysis are on going, especially for the assessment of the applicability [17].

## 6. References

- [1] EC-JRC (2010) Handbook - Framework and Requirements for Life Cycle Impact Assessment Models and Indicators' (2010). First edition March 2010. EUR 24586 EN.
- [2] Milà i Canals, L., et al 'Key Elements in a Framework for Land Use Impact Assessment within LCA', *Int J Life Cycle Assess* 12 (1) (2007) 5–15.
- [3] Koellner, T., et al. 'UNEP-SETAC Guideline on Global Land Use Impact Assessment on Biodiversity and Ecosystem Services in LCA', *Int J Life Cycle Assess* 18 (6) (2013) 1188–12029.
- [4] Souza, D.M., et al., 'Assessing biodiversity loss due to land use with Life Cycle Assessment: Are we there yet?', *Global Change Biology* 21 (2014) 32-47.
- [5] Curran, M., et al, 'Building consensus on biodiversity modelling in life cycle assessment: evaluation of current practice in land use impact assessment within and outside the field', In preparation.
- [6] Brandão, M., and Milà i Canals, L., 'Global Characterisation Factors to Assess Land Use Impacts on Biotic Production', *Int J Life Cycle Assess* 18 (6) (2013) 1243–52.

- [7] Beck, T., et al., 'LANCA@', Fraunhofer Institute for Building Physics.
- [8] Saad, R., et al, M., 'Land use impacts on freshwater regulation, erosion regulation, and water purification: a spatial approach for a global scale level', *Int J Life Cycle Assess* 18 (6) 1253-1264
- [9] Oberholzer, H.R, et al., 'A Novel Method for Soil Quality in Life Cycle Assessment Using Several Soil Indicators', *Agron Sustain Dev* 32 (3) (2012) 639–49.
- [10] Núñez, M., et al 'Assessing potential desertification environmental impact in life cycle assessment' *Int J Life Cycle Assess* 15 (2010) 67–78.
- [11] Garrigues, E., et al 'Development of a soil compaction indicator in life cycle assessment', *Int J Life Cycle Assess* 18 (2013) 1316-1324.
- [12] Núñez, M., et al 'Inclusion of soil erosion impacts in life cycle assessment on a global scale: application to energy crops in Spain', *Int J Life Cycle Assess* 18 (2013).
- [13] Alvarenga, R.F., et al, 'Exergy-based accounting for land as a natural resource in life cycle assessment', *Int J Life Cycle Assess* 18 (2013) 939–947.
- [14] Alvarenga, R.F., et al, 'Global land use impacts on biomass production—a spatial-differentiated resource-related life cycle impact assessment method', *Int J Life Cycle Assess* 20 (4) (2015) 440-450.
- [15] Gardi, C., Jeffery, S., Saltelli, A., 'An estimate of potential threats levels to soil biodiversity in EU', *Glob Change Biol* 19 (2013) 1538–1548
- [16] Burkhard, B., et al 'Mapping Ecosystem Service Supply, Demand and Budgets', *Ecological Indicators*, 21 (2012) 17–29.
- [17] Vidal Legaz B., et al. Review of existing land use models at midpoint: challenges and way forward (in preparation)

# Marine eutrophication impacts from present and future production of spring barley

Authors: Nuno Cosme and Monia Niero

Division for Quantitative Sustainability Assessment, Department of Management Engineering,  
Technical University of Denmark, Produktionstorvet 424, 2800 Kgs. Lyngby – Denmark

E-mail contact: [nmdc@dtu.dk](mailto:nmdc@dtu.dk)

## 1. Abstract

*Environmental emissions of nitrogen (N) from agriculture surplus may enrich coastal waters and trigger marine eutrophication impacts. We estimated these impacts for spring barley production in Denmark, under present and future climatic conditions with double carbon dioxide concentration and 5 °C increase. Characterised emissions of airborne ( $\text{NH}_3$  and  $\text{NO}_x$ ) and waterborne ( $\text{NO}_3^-$ ) forms result in an endpoint impact of  $2.35 \cdot 10^{-12}$  (North Sea) and  $8.47 \cdot 10^{-12}$  species.yr (Baltic Sea) under present conditions per kg spring barley produced. The future scenario shows 67% increase on both spatial units. Spatial differentiation shows 3.6 fold higher impacts in the Baltic Sea in any of the temporal scenarios. The need for food/feed, efficacy of increasing fertilizers application, and increased competition for productive land may alter emissions. Biological processes, species metabolism and displacement, or sensitivity to hypoxia under future pressures may alter the impacts assessment.*

## 2. Introduction

Agriculture and energy production are the main sources of environmental emissions of reactive nitrogen (N) [1]. The application of fertilizers in agriculture introduces  $\text{NH}_4^+$  and  $\text{NO}_3^-$  to soil and water, and  $\text{NH}_3$  to air, whereas the combustion of fossil fuels adds NO to air [2]. In agriculture practices, the N added to the soil may exceed plant assimilation. This surplus emitted to the environment may constitute the main cause for anthropogenic fertilization of freshwater and marine ecosystems that lead to aquatic eutrophication impacts. The global increasing application of N in agriculture and the energy production in the last 150 years led to more than 10-fold increase in the N-loadings to the environment [1]

Barley (*Hordeum vulgare L.*) is cultivated in 21% of the European Union's crop area [3], with a larger share in the Nordic countries, e.g. almost 50% in Denmark [4]; and expected to increase in the future by benefiting from the effect of climate change [5]. As such, nutrient supply will most likely increase to match crop requirements with potential N emissions increase [6].

Marine eutrophication (ME) is a syndrome of ecosystem responses to the increase of N availability in the euphotic zone of marine waters [7]. The N-enrichment of coastal waters promotes planktonic growth and often involves depletion of dissolved oxygen (DO) in bottom waters down to hypoxic or anoxic levels with potential impacts on exposed species [8][9][10].

We aim at estimating present and future ME impacts by combining a novel LCIA modelling approach and a LCI model case study.

## 3. Methods

We applied the LC-IMPACT methodology [11] to estimate the impacts on ME originating from N-enrichment in a case-study representative of spring barley production in Denmark. The life cycle inventory (LCI) model delivers emissions of  $\text{NO}_3^-$  to groundwater and  $\text{NH}_3$  and  $\text{NO}_x$  to air calculated per ha of

cultivated land [12] and kg yield. The characterisation method in the impact assessment (LCIA) includes: (i) environmental fate of waterborne N from nitrate emissions ( $\text{NO}_3^-$ -N) and airborne N deposition ( $\text{NH}_3$ -N and NO-N) [11]; (ii) ecosystem exposure expressing the potential of the receiving spatial units to assimilate N into planktonic biomass and to respire the sunken organic fractions in bottom waters where it consumes DO [13], and (iii) effect on benthic and demersal marine species based on their sensitivity to hypoxia by applying a Species Sensitivity Distribution (SSD) method [14].

We adopted the Large Marine Ecosystems (LME) biogeographical classification system [15] and used LME#22 (North Sea) and LME#23 (Baltic Sea) as spatial units receiving the emissions and for which the impacts were estimated. We further compare ME impacts under current and future climatic conditions. Emissions from future crop yields were obtained from experiments mimicking a worst case climate scenario, i.e. double  $\text{CO}_2$  concentration and 5 °C temperature increase, expected by the end of the century according to IPCC 2007 A1FI scenario [12]. Details on the experiment and scenarios modelled are shown in Table 1. The LCI model results of emitted quantities per emission route are included in Table 2.

#### 4. Results and Discussion

Preliminary results (Figure 1) show an endpoint impact of  $2.35 \cdot 10^{-12}$  species.yr (using ReCiPe's marine species density [16]) for emissions to the North Sea and  $8.47 \cdot 10^{-12}$  species.yr to the Baltic Sea, under present conditions, per kg of spring barley produced. The results for the future scenario show an increase to  $3.92 \cdot 10^{-12}$  species.yr (North Sea) and  $1.41 \cdot 10^{-11}$  species.yr (Baltic Sea), per kg of spring barley produced, corresponding to a 67% increase in both spatial units.

Spatial variation on the results (3.6 fold higher in the Baltic Sea) arises from different marine primary production rates (embedded in the exposure model) and species sensitivity to hypoxia (input to effect model) on both receiving marine coastal areas. Temporal variation towards the future climate scenario is justified by the decreased barley yield (-26% in same productive area), increased nitrate leaching (+24%), and assuming the same airborne emission rate per hectare. The impact model is kept constant. The uncertainty analysis of the LCI model identifies significant changes of the coefficient of variation from the baseline to future scenarios [17], thus stressing the need to improve the modelling of N emissions for agricultural systems.

Scenarios	Present	Future
Description	average cultivation sandy loam soil, i.e. JB6 of the Danish soil classification	$[\text{CO}_2] = 700$ ppm (ca. twice the amount of today) Temperature increase: +5°C
Fertilizer application	half of the N demand fulfilled by mineral fertilizer (NPK) and half by animal manure (50% pig slurry and 50% dairy cattle slurry)	
Crop yield [kg/ha]	5,700	4,207
Functional unit is <i>production of 1 kg of DM (dry matter) barley grain for malting</i>		
Nitric oxide (NO) to air [kg/ha]	1.77	1.77
Ammonia ( $\text{NH}_3$ ) to air [kg/ha]	7.34	7.34
Nitrate ( $\text{NO}_3^-$ ) to grwater [kg/ha]	126	157

Table 1: Present and future scenarios for the barley production system [12] and LCI elementary flows

Emissions	Present	Future	Unit
Nitric oxide (NO) to air	$1.45 \cdot 10^{-4}$	$1.96 \cdot 10^{-4}$	$\text{kgNO} \cdot \text{kg}_{\text{barley}}^{-1}$
Ammonia (NH <sub>3</sub> ) to air	$1.06 \cdot 10^{-3}$	$1.43 \cdot 10^{-3}$	$\text{kgNH}_3 \cdot \text{kg}_{\text{barley}}^{-1}$
Nitrate (NO <sub>3</sub> <sup>-</sup> ) to groundwater	$4.99 \cdot 10^{-3}$	$8.43 \cdot 10^{-3}$	$\text{kgNO}_3^- \cdot \text{kg}_{\text{barley}}^{-1}$
Characterisation Factors (CF)	North Sea (LME#22)	Baltic Sea (LME#23)	Unit
NO to air	31.92	115.23	$\text{PAF} \cdot \text{m}^3 \cdot \text{yr} \cdot \text{kgN}^{-1}$
NH <sub>3</sub> to air	31.28	112.90	
NO <sub>3</sub> <sup>-</sup> -N to water	128.20	462.78	

Table 2: Emission flows to environment for the present and future barley production scenarios.

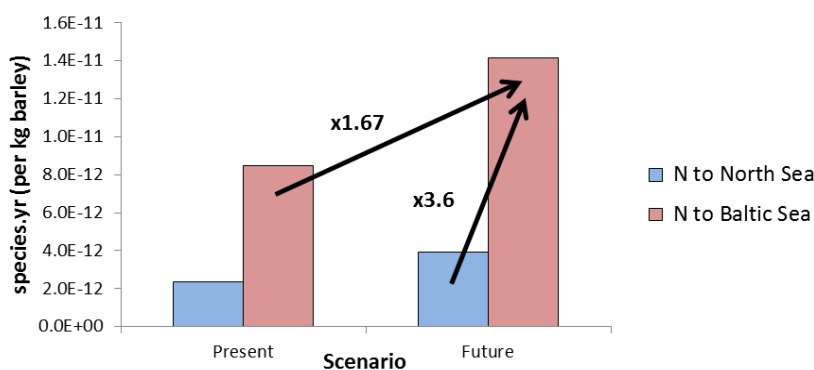

Figure 1: Impacts to marine eutrophication in the North Sea and Baltic Sea from the barley production in the present and future scenarios covered [species.yr]/FU

## 5. Conclusion

FAO's forecasting for the 1995-2030

the increase need for food and feed to sustain population increase (+40%), for efficacy of fertilizers application (+37%), and land use competition (only +7% arable land area) as reasons for intensified N emissions in addition to climate change effects. As for the LCIA method, future climatic conditions, which may alter rates of biological processes or organisms' metabolism, displace species (translation effect), or increase exposed species' sensitivity to hypoxia, suggest underestimation of ME impacts in that scenario.

## 6. References

- [1] Galloway, J.N., Townsend, A.R., Erismann, J.W., et al., 'Transformation of the Nitrogen Cycle: Recent Trends, Questions, and Potential Solutions', *Science* 320 (5878) (2008) 889–92.
- [2] Socolow, R.H., 'Nitrogen management and the future of food: Lessons from the management of energy and carbon', *Proc Natl Acad Sci USA* 96 (1999) 6001–6008.
- [3] European Union, 'Short Term Outlook for EU arable crops, dairy and meat markets in 2015-2016', [[http://ec.europa.eu/agriculture/markets-and-prices/short-term-outlook/pdf/2015-03\\_en.pdf](http://ec.europa.eu/agriculture/markets-and-prices/short-term-outlook/pdf/2015-03_en.pdf)] (2015).
- [4] Statistics Denmark, 'AFG1: crops by crop, unit and area', [<http://www.statbank.dk/AFG1>] (2014)
- [5] Trnka, M., Olesen, J.E., Kersebaum, K.C., et al., 'Agroclimatic conditions in Europe under climate change', *Glob. Chang. Biol.* 17 (2011) 2298-2318.
- [6] Doltra, J., Lægdsmand, M., and Olesen, J.E., 'Impacts of projected climate change on productivity and nitrogen leaching of crop rotations in arable and pig farming systems in Denmark'. *J. Agric. Sci.* 152 (2012) 75–92.
- [7] Cloern, J.E., 'Eutrophication', [<http://www.eoearth.org/view/article/152690/>] (2013).
- [8] Gray, J.S., Wu, R.S. and Or, Y.Y., 'Effects of hypoxia and organic enrichment on the coastal marine environment', *Mar Ecol Prog Ser.* 238 (2002) 249–79.

- [9] Kelly, J.R., 'Nitrogen Effects on Coastal Marine Ecosystems', in J.L. Hatfield and R.F. Follet (eds) 'Nitrogen in the Environment: Sources, Problems, and Management', US EPA (2008) 271–332.
- [10] Levin, L.A., Ekau, W., Gooday, A.J., et al., 'Effects of natural and human-induced hypoxia on coastal benthos', *Biogeosciences* 6 (2009) 2063–2098.
- [11] Azevedo, L.B., Cosme, N., Hauschild, M.Z., et al., 'Recommended assessment framework, method and characterisation and normalisation factors for ecosystem impacts of eutrophying emissions: phase 3 (report, model and factors)', (243827 FP7- ENV-2009-1) LC-IMPACT (2013).
- [12] Niero, M., Ingvordsen, C.H., Peltonen-Sainio, P., Jalli, M., Lyngkjær, M.F., Hauschild, M.Z. and Jørgensen, R.B. 'Eco-efficient production of spring barley in a changed climate: A Life Cycle Assessment including primary data from future climate scenarios', *Agric. Syst.* 136 (2015) 46–60.
- [13] Cosme, N., Koski, M. and Hauschild, M.Z., 'Exposure factors for marine eutrophication impacts assessment', *Ecol Model* (submitted).
- [14] Cosme, N. and Hauschild, M.Z., 'Effect Factors for LCIA of marine eutrophication based on species sensitivity to hypoxia', *Int J LCA* (in prep).
- [15] Sherman, K. and Alexander, L.M., 'Variability and management of large marine ecosystems', (Westview Press Inc., Boulder CO, 1986), 319 pp.
- [16] Goedkoop, M., Heijungs, R., Huijbregts M. et al., 'ReCiPe 2008, A life cycle impact assessment method which comprises harmonised category indicators at the midpoint and the endpoint level, 1st edition (revised) Report I: Characterisation', [<http://www.lcia-recipe.net>] (2012).
- [17] Niero, M., Ingvordsen, C.H., Jørgensen, R.B. and Hauschild, M.Z., 'How to manage uncertainty in future Life Cycle Assessment (LCA) scenarios addressing the effect of climate change in crop production', *J. Cleaner Prod.* (2015), doi: 10.1016/j.jclepro.2015.05.061.
- [18] FAO, 'World Agriculture: Towards 2015/2030', J. Bruinsma (Ed.) (Earthscan Publications, London, 2003), 432 pp.

# **Integration of Land Use aspects in LCA: determination of land use types as a crucial factor influencing the result**

Author(s): Daniel Arana<sup>2</sup>, Ulrike Bos<sup>1</sup>, Alexander Liedke<sup>3</sup>, Eva Knüpfper<sup>2</sup>, Stefan Albrecht<sup>2</sup>,  
Jan Paul Lindner<sup>2</sup>, Thilo Kupfer<sup>3</sup>

<sup>1</sup>*University of Stuttgart, Chair of Building Physics, Department Life Cycle Engineering,  
Wankelstrasse 5, 70563 Stuttgart, Germany*

<sup>2</sup>*Fraunhofer Institute for Building Physics, Department Life Cycle Engineering,  
Wankelstrasse 5, 70563 Stuttgart, Germany*

<sup>3</sup>*thinkstep AG, Hauptstrasse 111-113, 70771 Leinfelden-Echterdingen, Germany  
E-mail contact: ulrike.bos@lbp.uni-stuttgart.de*

## **1. Abstract**

*In recent years, scientists worldwide have worked successfully on the implementation of land use aspects into Life Cycle Assessment (LCA) [1-6]. However, there are still challenges to be met to get valuable and comparable results when using different land use calculation methods. In order to calculate land use information, land use types have to be determined and distinguished. The Department Life Cycle Engineering at the University of Stuttgart (LBP-GaBi) conducted a study to analyse the influence of the choice of the classification system and the respective land use types on the soil quality indicators used in LANCA<sup>®</sup> (Land Use Indicator Value Calculation) [3-4, 6]. Various classification systems like Global Land Cover 2000, GlobCover or the WWF Terrestrial Ecoregions of the World are investigated and analysed with respect to the application for the particular land use types [7-9]. Finally, based on these findings an approach for a standardized determination of land use types is developed [10].*

## **2. Introduction**

During the last years, the scarcity of land became an issue in science, politics and society. Land use caused by industrial processes such as mining, construction, and transportation, as well as agriculture and forestry, has an immense impact on the soil and land quality. It is therefore important to include land use aspects in life cycle thinking to assess products regarding their potential environmental impacts. Several methods were successfully developed during the last years to address e.g. ecosystem services in LCA [1-5].

The UNEP/SETAC working group on “Operational Characterization Factors for Land use Impacts on Biodiversity and Ecosystem Services” proposes a framework for the calculation of land use impacts [2]. For the assessment it is important to determine land use types as essential inventory information that influences the results of the impact assessment. Land use types describe the land cover at different times during a use of a patch of land (see Figure 1).

The determination of particular land use types in the UNEP/SETAC framework [2] shows several gaps:

No consistent approach for the identification of land use types

No consistent matching of the available global land use datasets

Differing definitions and suggestions for an appropriate reference situation

Due to the mentioned gaps, it is important to propose a methodological approach for a standardized determination of land use types in order to improve the comparability of the available land use calculation tools.

Another gap of the framework document is the correlation of the land use types with indicators from certain ecosystem services, like the soil functionality of a land area. The calculation model LANCA<sup>®</sup> (Land Use Indicator Value Calculation) [4], which was developed by the Department of Life Cycle Engineering at the University of Stuttgart (LBP-GaBi), allows a comprehensible correlation with indicator specific coefficients, however the definition of the land use types is vague and the availability of global land use data for the determination of land use types via GIS is not given.

Based on the gaps of the UNEP/SETAC framework and using the application example of land use impact calculation from LANCA<sup>®</sup>, a new method for the determination of land use types is developed [10].

### 3. Method

With the newly developed approach land use types are consistently derived from global land classification systems and correlated to indicators of ecosystem services related to soil functionality. The land use types and their determination and integration in the calculation model are displayed below.

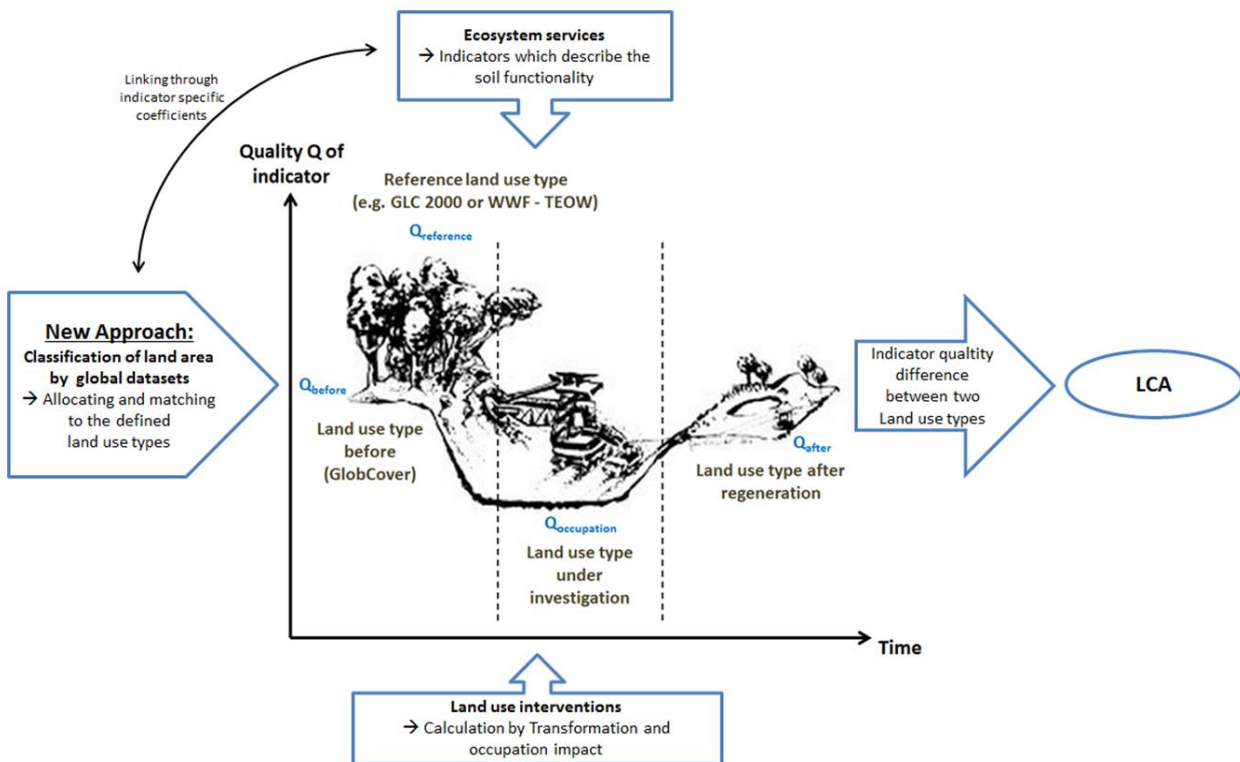

Figure 1: Determination of land use types for the calculation of land use impacts

The use of a patch of land is described by four land use types: The land use type before the land use under investigation, the specific land use under investigation, the land use type which evolves after a certain regeneration time without anthropogenic influences and the reference land use type. In order to match different land area characteristics or rather attributes to the defined land use types, land use datasets, which can be applied on a global scale, should consistently be used for each land use type. The classification systems of these land use datasets should be globally and freely available on a sufficiently fine spatial scale.



An analysis of several global land use classification systems identified the following global land use datasets, which can be correlated to the land use types, because they meet the mentioned requirements best:

- Land use type before the use under investigation ( $Q_{\text{before}}$  in Figure 1)
  - GlobCover [7]: This dataset is based on a global land use classification from 2009, and is appropriate for the use as land use type before the use under investigation, as it is up-to-date. Besides the data show high accuracy and are globally available.
- Land use type under investigation ( $Q_{\text{occupation}}$  in Figure 1)
  - same classification data from GlobCover can be used, however the land use type is known by the user.
- Land use type after regeneration ( $Q_{\text{after}}$  in Figure 1)
  - The vegetation forms which will likely evolve depending on the specific land use under investigation, on the biogeographic region and on the considered regeneration time, are matched with the GlobCover classification dataset. The GlobCover data which correspond to natural land area attributes like forest or herb and shrub vegetation can be defined as this land use type.
- Reference land use type ( $Q_{\text{reference}}$  in Figure 1)
  - Global land Cover 2000 (GLC 2000) [8]: land use mix from the year 2000 as reference type. GLC 2000 is based on the same classification system as GlobCover, but for the year 2000, and thus can be consistently used.

The land use data of the global datasets can be displayed in corresponding geographical maps for a GIS related identification on a global scale. In order for the determined land use types to show influence on the calculation results, the global land use data are correlated with indicator specific coefficients. The coefficients are derived dependent on the attributes of a given of land influencing the respective indicators. The indicators considered (e.g. Erosion Resistance of a soil) show different qualities for each land use type. A specific land use leads to quality changes of the respective indicator.

The following example shall quantitatively demonstrate the influence of the choice of different classification systems for land use types, particularly the choice of another reference land use type, like the biome classification of the WWF – Terrestrial Ecoregions of the World (TEOW) [9]:

- The indicator considered is the Erosion Resistance of a soil, which is subject to a quality change by the specific land use.
- The land use type under investigation is a mineral extraction site.
- The reference land use type corresponds to a mixed tree forest if considering the WWF-Terrestrial Ecoregions of the World classification and it is defined as cropland if considering the Global Land Cover 2000 classification. The results are presented in Table 1.

	Occupation impact = indicator quality (reference land use type) – indicator quality (land use type under investigation) * area * land use time	
Indicator	GLC 2000 as reference	WWF-TEOW as reference
Erosion in t	332	1.162

Table 1: Influence of the choice of different reference land use types

For the calculation of the occupation impact, the Erosion Resistance quality difference between the particular reference land use type and the land use type under investigation is multiplied with the evaluated area and land use time to determine the quality change. The choice of the WWF-TEOW results in a higher quality change of the Erosion Resistance rate at the evaluated location.

#### 4. Conclusion

The developed approach to determine the land use types fits in the UNEP/SETAC guidelines for land use impact assessment [2] and provides an improved and more applicable operationalization to evaluate land use impacts for the integration in LCA. The approach proposes and facilitates a consistent determination of land use types on a global scale and it is possible to identify land use types with the support of geographical information systems.

The choice of the reference land use type for example has a high influence on the results, which demonstrates the importance of consistency in the determination of land use types. With the developed method the determination of the land use type is made consistent and the calculation results of different methods are more reliable and comparable. Therefore one gap in land use modeling is closed.

#### 5. References

- [1] Milà i Canals L., Bauer C., Depestele J., Dubreuil A., Freiermuth Knuchel R., Gaillard G., Michelsen O., Müller-Wenk R., Rydgren B. (2007): Key elements in a framework for land use impact assessment within LCA. *Int J Life Cycle Assessment* 12:5–15.
- [2] Koellner T., de Baan L., Beck T., Brandão M., Civit B., Margni M., Milà i Canals L., Saad R., de Souza D., and Müller-Wenk R. (2013): UNEP-SETAC guideline on global land use impact assessment on biodiversity and ecosystem services in LCA. *Int J Life Cycle Assessment*, online first, published online: 02 February 2012.
- [3] Baitz M. (2002): Die Bedeutung der funktionsbasierten Charakterisierung von Flächen-Inanspruchnahmen in industriellen Prozesskettenanalysen: Ein Beitrag zur ganzheitlichen Bilanzierung. Dissertation. Berichte aus der Umwelttechnik. Aachen. Institut für Kunststoffprüfung und Kunststoffkunde, Universität Stuttgart: Shaker.
- [4] Beck T., Bos U., Wittstock B., Baitz M.; Fischer M.; Sedlbauer K. (2010): LANCA® – Land Use Indicator Value Calculation in Life Cycle Assessment. Fraunhofer Verlag, Stuttgart. ISBN 978-3-8396-0170-9.
- [5] Brandão M., Milà i Canals L. (2012): Global characterisation factors to assess land use impacts on biotic production. *Int J Life Cycle Assessment*, online first, published online: 1 May 2013.
- [6] Bos U. (2010): Documentation of land use indicator values in GaBi 4. Department of Life Cycle Engineering, University of Stuttgart.
- [7] Arino, Olivier; Ramos Perez, Jose Julio; Kalogirou, Vasileios; Bontemps, Sophie; Defourny, Pierre; Van Bogaert, Eric (2012): Global Land Cover Map for 2009 (GlobCover 2009). © European Space Agency (ESA) & Université catholique de Louvain (UCL), doi:10.1594/PANGAEA.787668.
- [8] Bartholomé, E., & Belward, A. S. (2005). GLC2000: a new approach to global land cover mapping from Earth observation data. *International Journal of Remote Sensing*, 26(9), 1959-1977.
- [9] Olson, D. M., Dinerstein, E., Wikramanayake, E. D., Burgess, N. D., Powell, G. V. N., Underwood, E. C., D'Amico, J. A., Itoua, I., Strand, H. E., Morrison, J. C., Loucks, C. J., Allnutt, T. F., Ricketts, T. H., Kura, Y., Lamoreux, J. F., Wettengel, W. W., Hedao, P., Kassem, K. R. (2001): Terrestrial ecoregions of the world (TEOW): a new map of life on Earth. *Bioscience* 51(11):933-938.
- [10] Arana, D. (2015): Development of a method for the determination of land use types for the application in life cycle assessment. Department of Life Cycle Engineering, University of Stuttgart.

# **Ecocentric Water Scarcity Index to address local and temporal climate variability: the case of a tomato sauce**

Alessandro Manzardo, Andrea Loss, Marco Mason, Lorenzo Spadotto, Antonio Scipioni

*CESQA, Department of Industrial Engineering, University of Padova*

*Address Via Marzolo 9, 35131 Padova (Italy)*

*E-mail contact: [scipioni@unipd.it](mailto:scipioni@unipd.it)*

## **1. Abstract**

*Due to water scarcity in a growing number of regions worldwide, the management of water resources has become central in international debates. In this context, the scientific community has actively worked on the development of tools and methods to address the potential environmental impacts related to water within the context of Life Cycle Assessment. The objective of this study was to develop and verify the applicability of a modified ecocentric Water Scarcity Index (WSI) starting from the WSI of Smakthin and the method of the Variable Monthly Flow (VMF) corrected with the Climate Moisture Index (CMI). Results from the application to a tomato sauce show that the introduction of VMF allowed to differentiate water scarcity impacts on a monthly basis while the introduction of CMI allowed to reflect the increased need of ecosystems that depends on surface water resources when climate conditions become less favourable.*

## **2. Introduction**

Due to increasing water scarcity in a growing number of regions worldwide, water management has become a major challenge that affects users, policymakers and businesses [1]. In this context, the scientific community has actively worked on the development of tools and methods to address the potential environmental impacts related to water within the context of Life Cycle Assessment [2]. Several impact assessment methods have been published in the past few years trying to address the impacts of degradative and consumptive uses on humans and/or ecosystems in water scarce regions [3]. One of the widely accepted metrics to address this impacts on ecosystems is the Water Scarcity Index (WSI) presented by Smakthin et al. [4]. The WSI was developed to quantify the pressure of anthropogenic water use on surface water-dependent ecosystems. According to a literature review, this index belongs to the family of the so-called ecocentric scarcity indices [5] and is assessed as a ratio of water withdrawals for human activities [ $\text{m}^3/\text{year}$ ] on the long-term Mean Annual Flow in a river (MAF) [ $\text{m}^3/\text{year}$ ] minus the Environmental Water Requirements [ $\text{m}^3/\text{year}$ ] (EWR). Despite its acceptance, this metric does not address temporal and spatial climate variability [6][7]. The objective of this study was to develop and verify the applicability of a modified ecocentric WSI to overcome the limitations related to climate and temporal variability of the method proposed by Smakthin et al. [4]. To test the applicability of the proposed modified index, a case study of a tomato sauce produced in the United States (US) has been performed.

## **2. Materials and Methods**

### *2.1 Development of the modified Ecocentric Water Scarcity Index*

To allow for the quantification of monthly values of the WSI, the MAF and EWR have been modified. MAF has been replaced by adopting the concept of the mean monthly flow [ $\text{m}^3/\text{month}$ ] (MMF) [6] that is quantified as the sum of the monthly base flow and the monthly quick flow of the water body under study.

To better reflect local climate variability, the Climate Moisture Index (CMI) has been used to correct the values of the monthly quick flow yielding a modified version of the MMF. The CMI is an aggregate measure of potential water availability imposed solely by climate variability [7]. Moreover, the EWR used in Smakthin [4] has been replaced by adopting the method of the Variable Monthly Flow of Pastor et al. [6] corrected by the modified MMF (equation 1):

$$EWR_{modified} \begin{cases} 60\%MMF \text{ if } MMF_{modified} < 40\%MAF \\ 40\%MMF \text{ if } 40\%MAF < MMF_{modified} < 80\%MAF \\ 30\%MMF \text{ if } MMF_{modified} \geq MAF \end{cases} \quad (1)$$

The proposed modified ecocentric WSI is then formulated according to equation 2:

$$WSI_{ecocentric} = \frac{Withdrawals}{MMF - EWR_{modified}} \quad (2)$$

## 2.2 WSI case study

To test the applicability of the proposed method, the modified ecocentric WSI has been applied to assess the impacts on water scarcity of a tomato sauce with life cycle processes located in different locations in the US. Table 1 summarizes the main processes and related locations.

Tomato sauce production process	Location
Tomato growing and processing	Florida (North of the state)
Granulated Sugar production	Louisiana (Mississippi area)
Soybean Oil production	Ohio (Ohio river area)
Primary Packaging	New York State
Tomato sauce production	New York State
Other processes (Distribution, Use, End of Life)	Different location in the northeast of the US

Table 1: Most relevant processes related to the tomato sauce

The water scarcity footprint has been assessed according to ISO 14046 requirements. The objective of the case study was to identify the potential hotspots related to the assessed tomato sauce. The function of the product (functional unit of the case study) is to provide high quality tomato sauce corresponding to a nutritional value of an equivalent of 6 cups of vegetables. The reference flow is defined as 680g of tomato sauce packed in a glass jar. The system boundaries include all the processes of the life cycle stages of the tomato sauce except the transport to the consumer from the distribution center and the use of energy to warm the sauce. Water use data (input and outputs of each process units) were either primary data collected directly from the suppliers and producers or secondary data from Ecoinvent 3. The modified ecocentric WSI was quantified for each of the locations under study. The base flow and the quick flow were determined using the software Web Based Hydrograph Analysis Tool [8]; the CMI was assessed starting from CLIMAWAT [9] data on local climate conditions.

#### 4. Results and discussion

Figure 1 shows the results of the quantification of the water scarcity footprint (95,87 liters) using the modified ecocentric WSI expressed on a monthly basis. Tomato growing and processing resulted to have the biggest footprint followed by granulated sugar production. To effectively reduce impacts on surface water-dependent ecosystems, the water use in agricultural processes should be optimized. By accounting for climate variability it was possible to identify that pressure on ecosystems is higher in the summer time when tomatoes are grown outdoors.

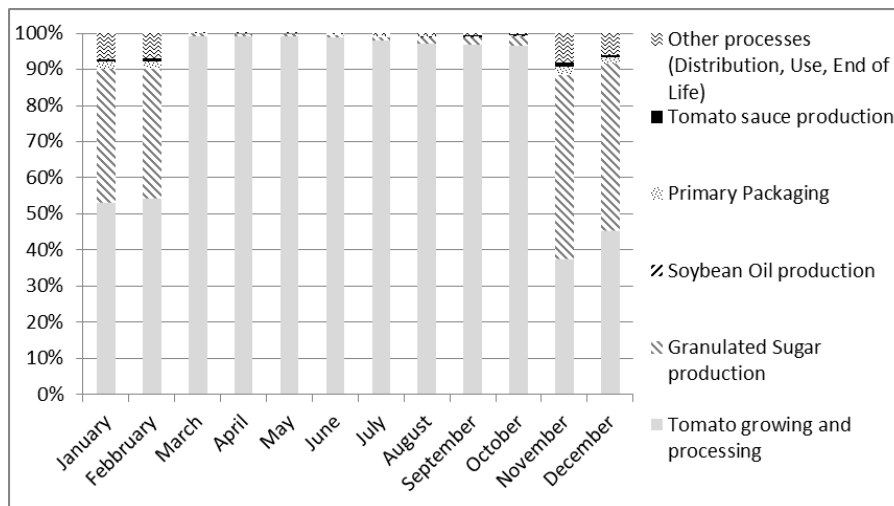

Figure 1: Results of water scarcity impact assessment for the tomato sauce case study

Figure 2 contrasts the results of the proposed EWR (EWR modified) with the EWR originally presented by Smakthin et al. [4]. Results show that when compared to the original EWR, EWR modified generally yields higher values. This means that more water is allocated to ecosystems. These effects depend on the introduction of CMI to correct MMF that reflects the potential increase of required water by ecosystems when evapotranspiration is higher due to climate conditions. It has to be noted that the proposed WSI index takes into account the human water withdrawals. The choice of using withdrawals instead of consumption, as proposed in many recent models of assessing water scarcity [3], is related to better represent the water stress on ecosystems on a monthly basis.

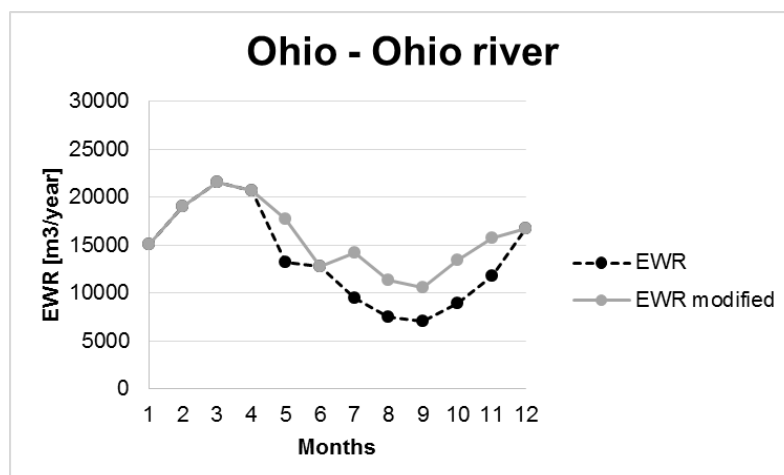

Figure 2: EWR [4] versus EWR modified in the case of the Ohio River(2012)

## 5. Conclusion

In this study, a proposal of a modified ecocentric WSI is presented. This index, starting from the method presented by Smakhtin et al. [4], has been modified to better represent the regional and temporal variability related to local climate conditions. The modified WSI has been developed using the CMI to consider the potentially increased water requirements by ecosystems when evapotranspiration is higher mainly because of higher temperature, increased solar radiation and dryer conditions. The applicability of the proposed ecocentric WSI was demonstrated in a case study of a tomato sauce. In the case study, it was possible to identify the hotspots related to water scarcity and the time of the year when these generate higher pressure on ecosystems.

## 6. References

- [1] El Gohemy, A.M.K., 'Future sustainable water desalination technologies for the Saudi Arabia: a review'. *Sustain energy rev.* 16 (2012) 6566-6597..
- [2] Bayart, J.B., Bulle, C., Deschênes, L., Margni, M., Pfister, S., Vince, F., Koehler, A., 'A framework for assessing off-stream freshwater use in LCA'. *Int J Life Cycle Assess.* 15 (2010), 439–453.
- [3] Kounina, A., Margni, M., Bayart, J-B., Boulay, A.M, Berger, M., Bulle, C., Frischknecht, R., Koehler A., Milà i Canals, L., Motoshita, M., Núñez, M., Peters G., Pfister, S., Ridoutt B., Van Zelm R., Francesca F., Humbert S. "Review of methods addressing freshwater use in life cycle inventory and impact assessment." *The Int. J. Life Cycle Assess.*, 18 (2013) 707-721.
- [4] Smakhtin, V., Revenga, C, Döll, P., 'A pilot global assessment of environmental water requirements and scarcity'. *Water Int.*, 29 (2004), 307–317.
- [5] Boulay, A.M., Bare, J., Benini, L., Berger, M., Klemmayer, I., Lathuilliere, M., Loubet, P., Manzardo, A., Margni, M., Núñez, M., Ridoutt, B., Worbe, S., Pfister, S., 'Building consensus on a generic water scarcity indicator for LCA-based water footprint: preliminary results from WULCA'. In: Schenck, R., Huizenga, D. (Eds.), 2014. *Proceedings of the 9th International Conference on Life Cycle Assessment in the Agri-Food Sector (LCA Food 2014)*, 8-10 October 2014, San Francisco, USA. ACLCA, Vashon, WA, USA.
- [6] Pastor, A. V., Ludwig, F., Biemans, H., Ho, H, Kabat, P., 'Accounting for environmental flow requirements in global water assessments'. *Hydrol. Earth Syst. Sci. Discuss.*, 10 (2013)14987– 15032.
- [7] Vorosmarty, C.J., Charles, J., Douglas, E.M., Green P.A., Carmen Revenga C., 'Geospatial Indicators of Emerging Water Stress: An Application to Africa'. 2005. *Ambio* 34 (2005), 230-236
- [8] Lim, K.J., Engel, B.A., Tang, Z., Choi, J., Kim K.S., Muthukrishnan, S., Tripathy, D., 'Automated web gis based hydrograph analysis tool, WHAT' *J. Am. Water. Resour. As.* (2005).
- [9] FAO (2010B) CLIMAWAT 2.0 database Rome, <http://www.fao.org/nr/water/infores>.



# Eco-innovation and industrial symbiosis in the food sector

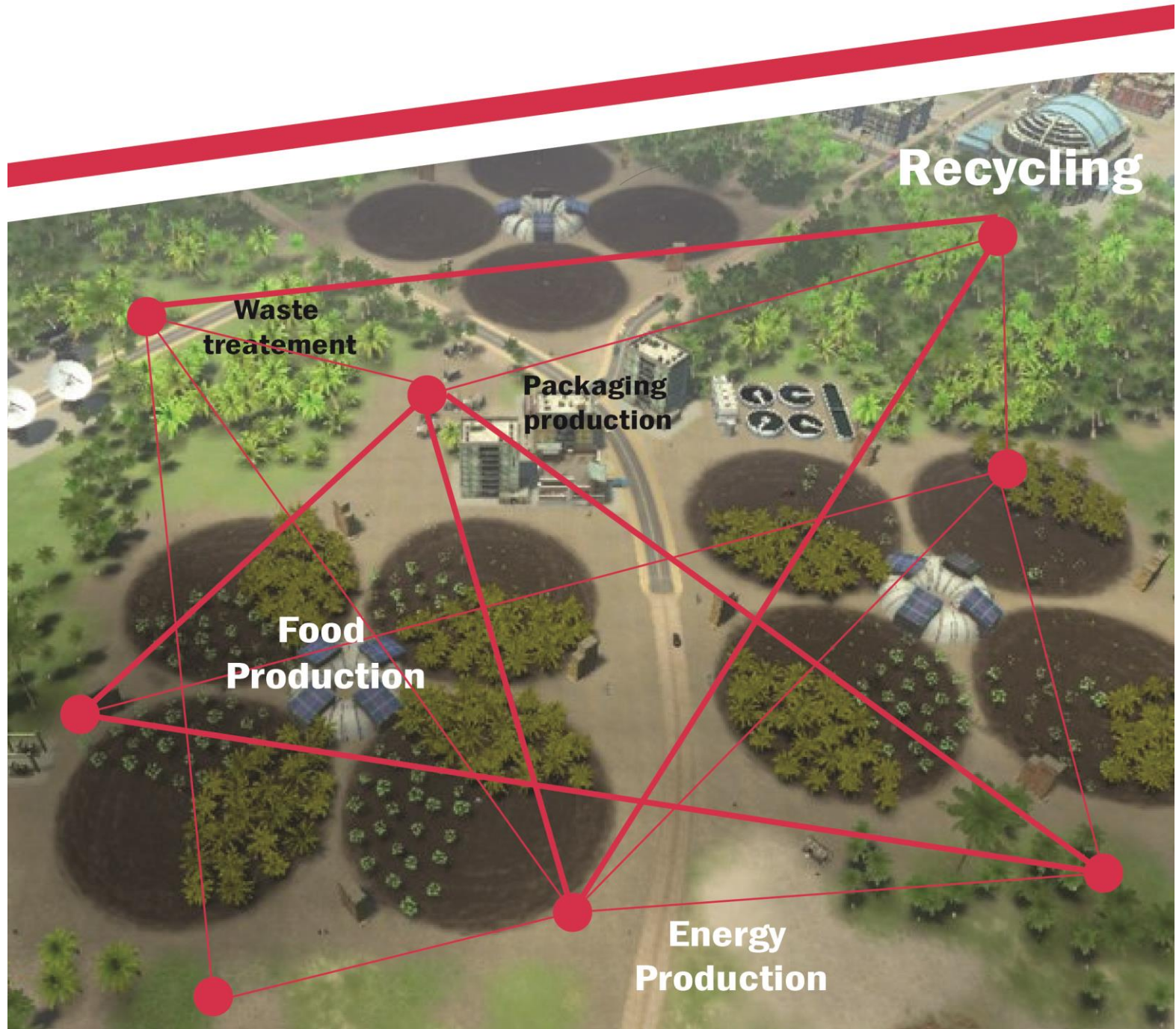

# Environmental assessment of Ultra-High Pressure Homogenisation for milk and fresh cheese production

Lucia Valsasina<sup>1,2</sup>, Massimo Pizzol<sup>1</sup>, Sergiy Smetana<sup>2</sup>, Erika Georget<sup>2</sup>, Alexander Mathys<sup>2</sup> and Volker Heinz<sup>2</sup>

<sup>1</sup>Department of Development and Planning, Aalborg University, Skibbrogade 5, Aalborg, Denmark

<sup>2</sup>German Institute of Food Technologies (DIL e.V.), Prof.-von-Klitzing-Str. 7, D-49610 Quakenbrück, Germany

E-mail contact: lucia.valsasina@gmail.com

## 1. Abstract

*Sterilisation is a necessary process to ensure the safety of shelf stable milk. Today's treatments rely on high temperatures to achieve it, but at the same time the product experiences losses of nutritional values. Ultra-High Pressure Homogenisation is an innovative processing technology that, combining sterilisation and homogenisation, provides a stable emulsion and has the potential of producing higher quality products. This study investigates the environmental impacts of UHPH for the production of milk and fresh cheese. The technology is compared to a common thermal process, Ultra-High Temperatures (UHT); moreover power laws are used to evaluate the consequences of scaling up. Keeping in mind the immaturity of the technology, the results show the potential of UHPH to reduce energy consumption and food waste, representing a valid alternative to existing technologies.*

## 2. Introduction

The food industry is a major source of greenhouse gas emissions, for instance dairy production contributes to 2.7% of total global emissions, 4% if meat is included as a coproduct [1]. The food industry therefore is in need for innovative ways to lower the impact of its products. In this research milk and fresh cheese production are taken as a case study for the environmental assessment of an innovative food processing technology, Ultra-High Pressure Homogenisation (UHPH). UHPH combines homogenization and sterilisation in a single step through the application of pressure up to 400MPa. The use of UHPH milk for the production of fresh cheese is then analysed, accounting for increased shelf life and yield.

## 3. Ultra-High Pressure Homogenisation

Shelf stable milk undergoes sterilisation to ensure the product's safety without refrigeration. The most common treatments applied today rely on the application of high temperatures to reduce the microbial (sporulated) flora, but strong thermal processing results in loss of nutritional values [2]. Research on the combination of dynamic high pressure and temperature, has shown successful results for sterilisation of food item with the potential of preserving the quality of the product [2]. UHPH relies on dynamic pressure from 200MPa up to 400MPa alimented by pistons or plungers, which force the liquid to pass through a narrow valve gap. Equipment usually has a high- and a low-pressure valve, which in combination with the chamber's geometry are determinant for successful processing [3]. Homogenisation is due to a combination of pressure, shear stress, turbulence, cavitation, impingement and temperature; in fact the shear effect causes an increase of ~20 °C per 100MPa. The application of UHPH for sterilisation purposes is a novelty. Amador-Espejo et al. [4] and Georget et al. [5] investigated the parameters for spore inactivation finding pressure of >300MPa, inlet temperature ~80 °C and a valve temperature of >145 °C for ~0.24s to be effective. These parameters were used to test pilot scale UHPH equipment.



#### 4. Methods

To provide an environmental assessment of UHPH, the technology is compared to indirect Ultra High Temperature (UHT) treatment by means of life cycle assessment (LCA). The processing of milk is taken as basis for comparison, and its effects on the supply chain of fresh cheese are accounted as well. UHT was chosen for the comparative part of the study to assess the performance of emerging versus conventional treatments. Moreover, tests were conducted for two different sizes of UHPH equipment, providing the basis for scaling considerations. Pilot scale data were collected for the following cases: UHPH equipment (Stansted Fluid Power, UK) with capacity of 90 l/h was tested with water, phosphate buffered saline (PBS), skimmed milk (1.5%) and whole milk (3.5%); UHPH with capacity of 360 l/h (DIL Prototype, Germany) with water; and an 85 l/h indirect UHT system (TetraPak line, Sweden), comprising upstream homogenisation, with water. As the test on UHPH 90 l/h showed no difference in energy consumption for the four substances, water alone was used for the following equipment in order to determine the energy requirements and product flow. The functional unit set for the study was the treatment of 1000 l of raw milk to reach commercial sterility. Processing is the only stage included for the comparative part. For cheese production distribution, retail, consumer and end-of-life stages are included as well. The indirect UHT processing line was built to include pre-heating of the product to 80 °C, as for UHPH, sterilisation at 145 °C for 4 seconds and cooling. Moreover a cycle of cleaning in place (CIP) was included for both machineries. Consequential LCA modelling was applied in the inventory phase, impact assessment results were obtained using “ReCiPe midpoint (E), Europe”. Calculations were performed with the software SimaPro 8.0.4.30 (PRé Consultants, The Netherlands). Data on the production of fresh cheese from UHPH treated milk were taken from Escobar [6] Zamora and Guamis [7], who found an increase in shelf life from ~13 to ~19 days and yield from 11 to 14%. The boundaries are set to include stages from production to disposal. The increase in shelf life was included deriving the predicted waste percentage according to days of life left modelled by WRAP [8].

Pilot scale results can differ according to the used equipment and a number of parameters vary with scale. It is therefore important to include scaling considerations in LCA studies in particular when looking at novelties. In order to estimate the possible future development of UHPH for industrial application, power laws are used. Caduff et al [9] tested this method for a series of engines. Scaling laws are in the form  $i = a \cdot x^{bi}$ , where “i” is a key parameter, “a” a normalisation constant and “b” the scaling factor. The same relationship is then applied to environmental impacts. In the case of the considered UHPH equipment, both homogenisers are positive displacement pumps of the reciprocating group. For a given pressure in volumetric pumps, capacity and energy consumption are linearly related to speed. These parameters are taken into consideration to assess the consequences of industrial application. Additionally empirical data from similar pressure pumps were integrated to provide an overview of the technology’s potential.

#### 5. Results and discussion

UHPH showed lower energy consumption combining homogenisation and sterilisation in a single process and heat loss was predicted as a hotspot [7]. UHPH outperform UHT at pilot scale. For both systems the process of sterilisation is the most energy intensive followed by pre-heating. At industrial level indirect UHT

can provide up to 90% energy recovery [10] through the use of heat exchangers, which minimise the impact of heating and cooling, making it a more energy efficient solution. For this reason the technological readiness level was included in the study's discussion. The inclusions of heat exchanger can potentially minimise UHPH energy requirement for heating and cooling, achieving a minimum of energy recovery of 57% and a decrease of 43% of emissions of kgCO<sub>2</sub>eq. These considerations are particularly important for the assessment of processing technologies as they are usually evaluated in economic terms. Electricity production is the activity that is mainly responsible for the selected impact categories: climate change, freshwater eutrophication, and human, marine and freshwater ecotoxicity. When energy consumption becomes relatively less important cleaning agents and wastewater treatment contribute in particular to climate change and eutrophication.

The model to calculate the consequence of increased shelf life is built for milk but the authors suggest its use for product with a similar durability and consumption pattern. Fresh cheese has a similar shelf life but frequency of consumption varies according to countries. According to WRAP [8] there is no previous empirical study on this topic. It is acknowledged the difficulty of modelling consumers' behaviour and the deriving uncertainties. The analysis of fresh cheese production, which excludes farm stages knowing they represent the biggest sources of emissions, shows that 10% of the impacts on climate change derives from processing. Transport and refrigeration, and consequently fuel and electricity, are the other activities that have large impact for cheese. Increased shelf life does not bring large environmental benefits because the amount of food saved is predicted to be small (0.5%). On the other hand food waste, malnutrition and battle for land are three of the main concerns of modern society. The overall impact of fresh cheese production was estimated integrating Schmidt and Daalgard [11] carbon footprint of dairy at farm. The LCIA methodologies were aligned for consistency. Including the farm stage the benefits, in terms of CO<sub>2</sub> eq., deriving from decreased waste increase by more than 50%. Scaling showed linear relationship between the main variables and therefore also for environmental impacts. The main finding was a significant increase in efficiency between the two different sizes UHPH and empirical evidence. The impact of the smaller pilot scale is 40% higher; this confirms the importance of the inclusion of scaling and of technological readiness in life cycle studies for novelties.

## 6. Conclusions

UHPH is a promising technology that could provide a higher quality product and decrease energy consumption. The investigation of UHPH is suggested also in other industries, such as cosmetics and pharmaceutical, as it could bring significant advantages.

## 7. References

- [1] Milani, F.X., Nutter, D. and Thoma, G., 'Invited review: Environmental impacts of dairy processing and products: A review' *J. Dairy Sci.* 94 (9) (2011) 4243-4254.
- [2] Georget, E., Miller, B., Callanan, M., Volker, H. and Mathys, A., '(Ultra) High Pressure Homogenization for Continuous High Pressure Sterilization of Pumpable Foods - A Review', *Frontiers in Nutrition* 1 (2014) 1–6.
- [3] Dumay, E., Chevalier-Lucia, D., Picart-Palmade, L., Benzaria, A., Gràcia-Julià, A. and Blayo, C., 'Technological aspects and potential applications of (ultra) high-pressure homogenisation' *Trends in Food Sci. & Technol.* 31 (1) (2013) 13-26.

- [4] Amador Espejo, G.G., Hernández-Herrero, M.M., Juan, B. and Trujillo, A.J., 'Inactivation of Bacillus spores inoculated in milk by Ultra High Pressure Homogenization', *Food Microbiology* 44 (2014) 204–210.
- [5] Georget, E., Miller, B., Aganovic, K., Callan, M., Heinz, V. and Mathys, A., 'Bacterial spore inactivation by ultra-high pressure homogenization', *Innov. Food Sci. and Emerg. Technol.* 26 (2014) 116-123.
- [6] Escobar, D., Clark, S., Ganesan, V., Repiso, L., Waller, J. and Harte, F., 'High-pressure homogenization of raw and pasteurized milk modifies the yield, composition, and texture of queso fresco cheese', *J. Dairy Sci.* 94 (2011) 1201-1210.
- [7] Zamora, A. and Guamis, B., 'Opportunities for Ultra-High-Pressure Homogenisation (UHPH) for the Food Industry' *Food Eng. Rev.* 136 (3) (2010) 261-267.
- [8] WRAP, 'The Milk Model: Simulating Food Waste in the Home', WRAP (2013). Available at: <http://www.wrap.org.uk/sites/files/wrap/Milk%20Model%20report.pdf>
- [9] Caduff, M., Huijbregts, M.A.J., Koehler, A., Althaus, H. and Hellweg, S., 'Scaling Relationships in Life Cycle Assessment The Case of Heat Production from Biomass and Heat Pumps', *J. of Ind. Ecol.* (2014) 1-14.
- [10] Lewis, M.J. and Deeth, H.C., 'Heat Treatment of Milk' In A. Y. Tamime, ed. *Milk Processing and Quality Management*. Chichester: Blackwell Publishing, (2009) 168–204.
- [11] Schmidt, J. H. and Dalgaard, R., 'National and farm level carbon footprint of milk: Methodology and results for Danish and Swedish milk 2005 at farm gate', Arla Foods, Aarhus, Denmark (2012).

# Strategies for reducing food waste: Life Cycle Assessment of a pilot plant for insect-based feed products

Authors: Salomone R.<sup>1</sup>, Saija G.1, Mondello G.<sup>1</sup>, Pirilli M.<sup>1</sup>, Giannetto A.<sup>2</sup>, Fasulo S.<sup>2</sup>, Savastano D.<sup>3</sup>

<sup>1</sup>University of Messina, Department of Economics, Business, Environment and Quantitative Methods,  
P.zza Pugliatti n.1, 98122 Messina (Italy) +39 090 771548

<sup>2</sup>University of Messina, Department of Biological and Environmental Science ,  
Via F. Stagno D'Alcontres n.31, 98166 Messina (Italy) +39 090 6765544

<sup>3</sup>Biosistemi Srls - SS 111 n.68, 89013 Gioia Tauro (Italy) +39 338 6626612

E-mail contact: [salomoner@unime.it](mailto:salomoner@unime.it)

## 1. Abstract

*Food waste is an emerging problem that needs solutions for reducing it. A promising strategy is its utilisation as substrate for mass-rearing of edible insects to be used as a protein source for the livestock sector. This is a potentialy valuable solution to two serious problems: the increasing amount of food waste and the global rising demand for feed. Plenty of studies have investigated the nutritive composition of insects and their utilisation as a source of protein for human consumption and animal feeding but less studied are the environmental consequences associated with their mass-rearing. LCA methodology can be applied to evaluate the potential environmental impacts of this process. In this context, this paper presents the results of an LCA of a pilot plant for rearing of “Hermetia illucens”, located in South Italy.*

## 2. Introduction

Food waste (FW) is an problem that urgently requires strategies for reducing it. Indeed, the EU [1] estimated that FW amounts in the EU27 to 89 million tonnes per annum and the projection for 2020 is 126 million tonnes (about 40% increase). Strategies to address the problem are oriented to improving the efficiency of food supply and consumption chains on the one hand and to find new solutions for FW treatment and valorisation on the other. In the context of waste valorisation, a promising strategy is the utilisation of FW as substrate for mass-rearing of edible insects to be used as a protein source for the livestock sector. They represent a potential valuable solution to two problems: the increasing amount of FW and the global rising demand for feed. In the international literature plenty of studies investigated the nutritive composition of insects and their utilisation as a source of protein both for human consumption and animal feeding, but less studied are the environmental consequences associated with their mass-rearing [2]. In order to properly evaluate the sustainability of insect-based products and their role as a valuable alternative of FW valorisation, the quantification of the environmental impacts associated to the whole life cycle of these processes should be carried out.

## 3. Methods

Life Cycle Assessment (LCA) is a methodology, standardized by ISO [3-4], which is applied to evaluate the environmental impact of the whole life cycle of a product, process or activity. LCA can be applied to evaluate the potential environmental impact of insect-based products, but there is still a lack of LCAs in this specific field of research and further applicative studies are necessary to broaden the environmental knowledge on the production of insect-based products. Following on, this paper presents the results of a

LCA, focused on the energy profiles (which are indicated as the main impacting in [2]), applied on a pilot plant for mass-rearing of *Hermetia illucens*, located in South Italy, producing 300 kg/day of dried larvae (used as fishmeal) and 3,346 kg/day of larvae manure (used as compost).

### 3.1 Scope of the study and Life Cycle Inventory Analysis

The scope of the analysis is to quantify the environmental impacts, with a specific focus on energy profiles, attributed to the production of insect-based feed products from mass-rearing of *Hermetia illucens* fed with FW from different sources. Primary data were collected from a pilot plant located in South Italy. To carry out the LCA study four different phases were analysed (Figure 1): eggs and larvae production (phase 1), substratum production (phase 2), compost and dried larvae production (phase 3), and distribution (phase 4). The input and output data are related to the functional unit of *one ton of food waste treated through larvae biodigestion*. Disposal of inorganic wastes (paper, plastic, etc.), obtained in the de-packing phase, is not included in system boundaries because out of the scope of this analysis. Are also excluded from the inventory GHG emissions at plant from the different processes, for the following motivations:

- the main focus of the study is on energy profiles (which are indicated as the main impacting in the only published LCA study on larvae meal [2])
- according IPCC, CH<sub>4</sub> emissions from organic waste occur only after several months, but in the investigated plant the whole process is completed in few days, so that these emissions are assumed as negligible and they were excluded from the inventory;
- no specific inventory data are present in the published international literature concerning other GHG emissions during the biodigestion activity of *Hermetia illucens*, so that it was not possible include them in the inventory;
- the only published LCA study on larvae meal [2] estimated the CH<sub>4</sub> production potential considering municipal organic waste and vegetable FW, but to our knowledge, to many uncertainties are associated with this choice because it is still unknown the difference between methane production potential of FW and larvae manure. So that the inclusion of this aspect would have imposed excessive uncertainty.

In addition to primary data, secondary data, only for pre-production processes (the ecoinvent database [5]), and literature data, for pruning waste combustion emissions [6], were utilized.

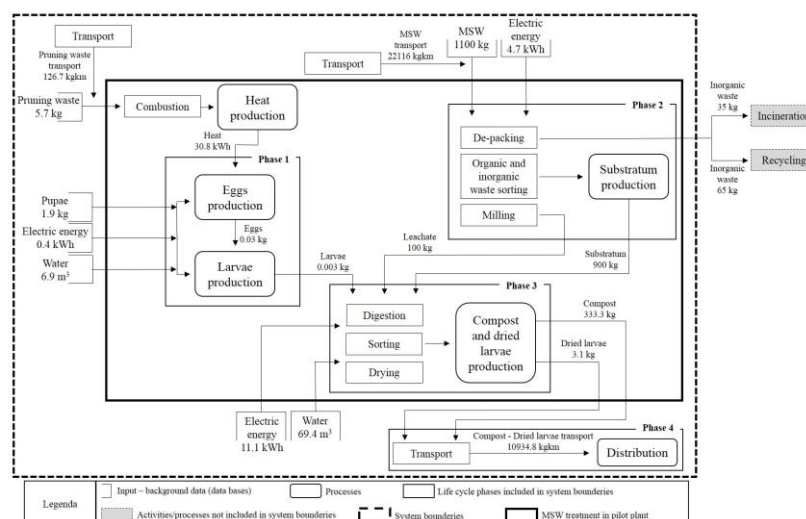

Figure 1: Phases and main inventory data for 1 t of food waste treated

### 3.2 Life Cycle Impact Assessment (LCIA)

SimaPro 8 software [7] was used to assess the environmental impact of the considered system. LCIA was conducted using CML 2 baseline 2000 method [8] (considering the ten different impact categories detailed in Figure 2), except for Global Warming Potential (GWP) for which the IPCC 2007 GWP 100a v. 1.02 method [9] was used.

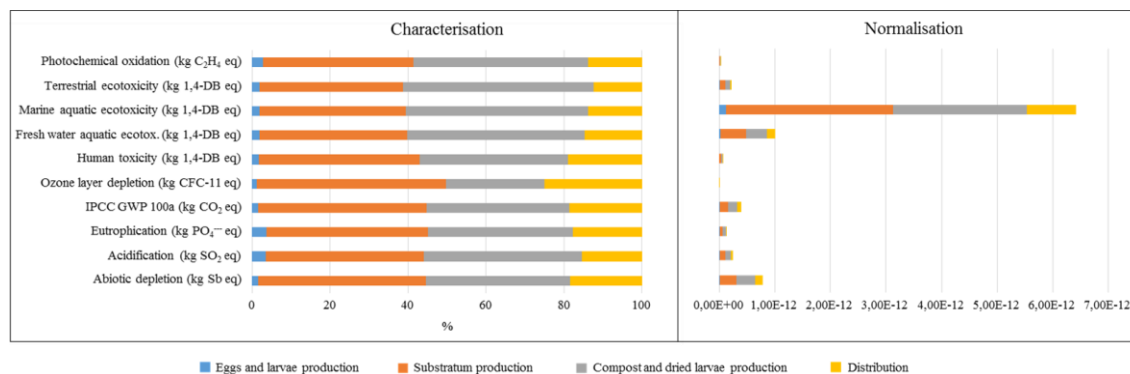

Figure 2: LCIA characterisation and normalisation results

Characterisation results (Figure 2) highlight that higher environmental impacts for each category are caused by phases 2 and 3; the lowest impacts are associated to phase 1. For example, considering the total impact related to GWP (17.6 kg CO<sub>2</sub> eq), the contribution of phases 2 and 3 is respectively 7.6 kg CO<sub>2</sub> eq and 6.5 kg CO<sub>2</sub> eq; while phase 1 contributes for 0.3 kg CO<sub>2</sub> eq. An examination in depth underscores that, in the substratum production (phase 2), the transport of municipal solid waste contributes about 60% to the total impact of each category; on the other hand, in the compost and dried larvae production (phase 3), electric energy consumed in the drying sub-process contributes about 90%. The comparison of impact categories through normalisation step (Figure 2) highlights that the most influenced compartment is the marine aquatic ecotoxicity (6.4E-12 Pt). A detailed analysis shows that the main processes which contribute to this impact category result are: the transport of municipal solid waste to the treatment plant (18.1 %), in phase 2, and the consumption of electric energy in milling (phase 2) and drying (phase 3) sub-processes (67.3 %).

## 4 Conclusion

The LCA analysis on the production of insect-based products shows that the phases with the highest environmental impacts are substratum production and compost and dried larvae production; furthermore, the compartment mainly affected is the marine aquatic ecotoxicity, greatly caused by the transport of municipal solid waste to the treatment plant and the consumption of electric energy in milling and drying sub-processes.

Many uncertainties and data lacks still remain and need to be further investigated in future improvement of the research. In particular, a key aspect on which the authors are still working considering that no specific inventory data of *Hermetia illucens* is present in the published international literature, is to find a solution for collecting primary data for air emissions (no emissions in water and soil are caused by the process), carrying out experimental studies on the GHG emissions from the whole process.

Consequently a sensitivity analysis will be carried out in order to evaluate the consequences associated to uncertainty of this and other parameters.

## 5. References

- [1] Milani, F.X., Nutter, D. and Thoma, G., 'Invited review: Environmental impacts of dairy processing and products: A review' *J. Dairy Sci.* 94 (9) (2011) 4243-4254.
- [2] Georget, E., Miller, B., Callanan, M., Volker, H. and Mathys, A., '(Ultra) High Pressure Homogenization for Continuous High Pressure Sterilization of Pumpable Foods - A Review', *Frontiers in Nutrition* 1 (2014) 1–6.
- [3] Dumay, E., Chevalier-Lucia, D., Picart-Palmade, L., Benzaria, A., Gràcia-Julià, A. and Blayo, C., 'Technological aspects and potential applications of (ultra) high-pressure homogenisation' *Trends in Food Sci. & Technol.* 31 (1) (2013) 13-26.
- [4] Amador Espejo, G.G., Hernández-Herrero, M.M., Juan, B. and Trujillo, A.J., 'Inactivation of *Bacillus* spores inoculated in milk by Ultra High Pressure Homogenization', *Food Microbiology* 44 (2014) 204–210.
- [5] Georget, E., Miller, B., Aganovic, K., Callan, M., Heinz, V. and Mathys, A., 'Bacterial spore inactivation by ultra-high pressure homogenization', *Innov. Food Sci. and Emerg. Technol.* 26 (2014) 116-123.
- [6] Escobar, D., Clark, S., Ganesan, V., Repiso, L., Waller, J. and Harte, F., 'High-pressure homogenization of raw and pasteurized milk modifies the yield, composition, and texture of queso fresco cheese', *J. Dairy Sci.* 94 (2011) 1201-1210.
- [7] Zamora, A. and Guamis, B., 'Opportunities for Ultra-High-Pressure Homogenisation (UHPH) for the Food Industry' *Food Eng. Rev.* 136 (3) (2010) 261-267.
- [8] WRAP, 'The Milk Model: Simulating Food Waste in the Home', WRAP (2013). Available at: <http://www.wrap.org.uk/sites/files/wrap/Milk%20Model%20report.pdf>
- [9] Caduff, M., Huijbregts, M.A.J., Koehler, A., Althaus, H. and Hellweg, S., 'Scaling Relationships in Life Cycle Assessment The Case of Heat Production from Biomass and Heat Pumps', *J. of Ind. Ecol.* (2014) 1-14.
- [10] Lewis, M.J. and Deeth, H.C., 'Heat Treatment of Milk' In A. Y. Tamime, ed. *Milk Processing and Quality Management*. Chichester: Blackwell Publishing, (2009) 168–204.
- [11] Schmidt, J. H. and Dalgaard, R., 'National and farm level carbon footprint of milk: Methodology and results for Danish and Swedish milk 2005 at farm gate', Arla Foods, Aarhus, Denmark (2012).

# Environmental Impact Assessment of caproic acid production from organic waste: A case study of a novel pilot-scale biorefinery in the Netherlands

Wei-Shan, Chen<sup>1,2</sup>, David PBTB, Strik<sup>2</sup>, Cees JN, Buisman<sup>2</sup>, and Carolien, Kroeze<sup>1</sup>

<sup>1</sup>*Environmental Systems Analysis Group, Wageningen University, PO Box 9101,  
6700 HB Wageningen, The Netherlands*

<sup>2</sup>*Sub-department of Environmental Technology, Wageningen University,  
Bornse Weilanden 9, 6708 WG Wageningen, The Netherlands*

*E-mail contact: [wei-shan.chen@wur.nl](mailto:wei-shan.chen@wur.nl)*

## 1. Abstract

*Mixed Culture Chain Elongation (MCCE) is a novel biotechnology process that converts organic waste and ethanol into valuable biochemicals. A MCCE-Biorefinery pilot plant has been established in Amsterdam, the Netherlands since 2014, which intends to use supermarket food waste and crop-based bioethanol as feedstock to produce caproic acid, a saturated 6-carbon carboxylic acid. An Environmental Impact Assessment (EIA) on the MCCE-biorefinery is performed based on several previous MCCE studies and the MCCE-biorefinery pilot plant: we present the main source(s) of environmental impacts in the MCCE-Biorefinery and the environmental consequences of potential optimisation strategies. The results can guide the future technological researches on MCCE, and also support optimisation and decision making in upscaling and actual implementation of the MCCE-Biorefinery.*

## 2. Introduction

MCCE is a novel biotechnology process that converts organic waste into valuable biochemicals [1-3]. The MCCE process consists of two steps: first, a biological acidification step in which complex organic matters in the waste streams are degraded into basic building blocks like Volatile Fatty Acids (VFAs, saturated carboxylic acids with 2~4carbons) and/or carbon dioxide (CO<sub>2</sub>) by microorganism; second, a chain elongation step in which acetate and/or CO<sub>2</sub> is elongated with externally added bioethanol into caproic acid, a saturated 6-carbon carboxylic acid having diverse biochemical applications (Figure 1). MCCE-Biorefinery is an integration of MCCE and several essential steps like separation and purification to convert organic waste into caproic acid. Such integration has been realised by Chaincraft in a MCCE-Biorefinery pilot in Amsterdam, the Netherlands since 2014. This pilot uses supermarket food waste and crop-based bioethanol as feedstock to produce caproic acid as the end product.



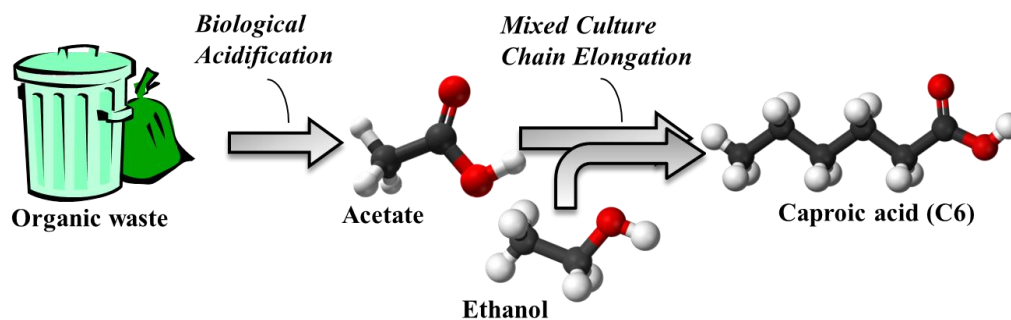

Figure 1: Two main steps for caproic acid production from organic waste : the biological acidification which degrades complex organic matter into VFAs and the MCCE which elongates the VFAs with additional ethanol to form longer chain carboxylic acid.

Caproic acid has several chemical applications. It can be directly applied as commodity chemicals; it can also serve as precursors of various biofuels and biochemicals [4]. The current production of caproic acid relies on plant oils like coconut and palm kernel oils [5]. Producing these oils requires arable land for plantations, which may lead to competition with food production for arable land. MCCE-Biorefinery offers an alternative process that produces caproic acid from organic waste streams, which is potentially more renewable and geographically unbound.

In this study we evaluate the environmental performance of MCCE-Biorefinery by quantifying the potential environmental impacts of the partial life cycle of the caproic acid production from the MCCE-Biorefinery pilot (Figure 2). We present the main source(s) of the selected environmental impact categories, which is useful in formulating optimisation strategies for MCCE-Biorefinery. Subsequently we will simulate the environmental consequence of the potential optimisation strategies for the MCCE-biorefinery. The overall results can support decision making when upscaling and actual implementation of MCCE-Biorefinery converting supermarket food waste into valuable biochemicals in the Netherlands.

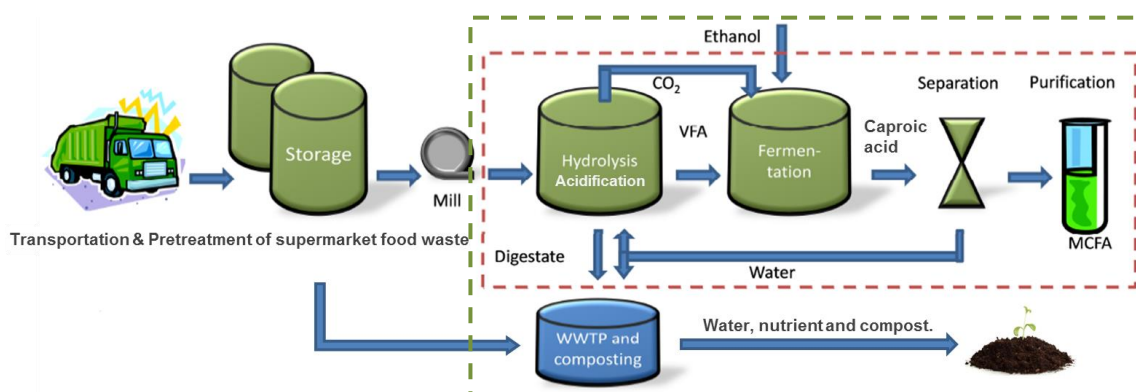

Figure 2 : Partial life cycle (from gate to product) of caproic acid production from organic waste. The green dot line indicates the system boundary of this study, while the red dot line indicates the processes that take place in MCCE-Biorefinery pilot plant.

### 3. Methodology

A life cycle approach is applied in this EIA study. System boundaries are specified as shown in Figure 2. The partial life cycle starts from the organic waste entering the plant and ends after the production of the purified product, including the waste treatment. The functional unit (f.u.) is set as 1 kg purified caproic acid. Descriptions of the processes included and the flows related to each process are presented in Figure 3. The

process design is adopted from the actual design of the MCCE-biorefinery pilot plant and several previous MCCE studies [6, 7]. The process data and assumptions used in life cycle inventory (LCI) are mainly from the aforementioned previous MCCE studies, our own experiments and the literature. The Characterization Factor (CF) used in Life Cycle Impact assessment (LCIA) are from Ecoinvent 3 [8].

#### 4. First results and discussion

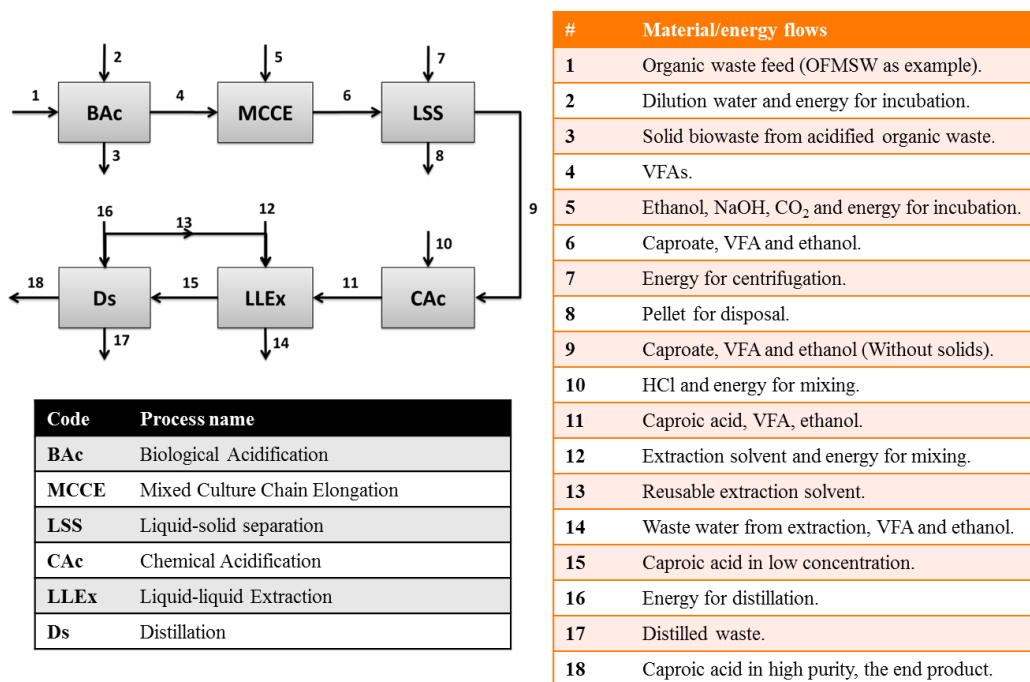

Figure 3: The main processes and material/energy flows included in the life cycle of caproic acid production in MCCE-biorefinery. OFMSW= Organic fraction of municipal solid waste, which is used as substrate in previous MCCE study for caproic acid production [1]

The environmental impacts generated in the partial life cycle of the caproic acid production for the selected environmental impact categories are presented in Figure 4. The life cycle impact on Global Warming (GWP) is to a considerable extent from solid waste management in the Biological Acidification (BAc) process. The organic waste used in this model is OFMSW (Figure 3) containing 90% lignocellulosic waste and 10% food waste [1]. The lignocellulosic part of OFMSW is difficult to be degraded in the BAc process, which resulted in large solid waste production. The abovementioned pilot plant will use supermarket food waste that has higher conversion efficiency into VFAs, which can reduce the solid waste production.

For both acidification and eutrophication, the uses of ethanol and ethyl caproate (as extraction solvent) dominate the overall impact potential. This dominance is attributed to the production of bioethanol, as production of ethyl caproate also requires ethanol as substrate. Potential strategies to reduce the environmental impact include (1) the use of ethanol from different feedstocks, (2) reuse of waste water from LLEx (Figure 3) that still contains residual ethanol and (3) use of different extraction solvents. The feasibility of the first strategy depends on the availability of the ethanol from different feedstocks, while the other two strategies have been successfully implemented in experiments. In our study we will further elaborate on the potential environmental consequences of these improvement strategies.

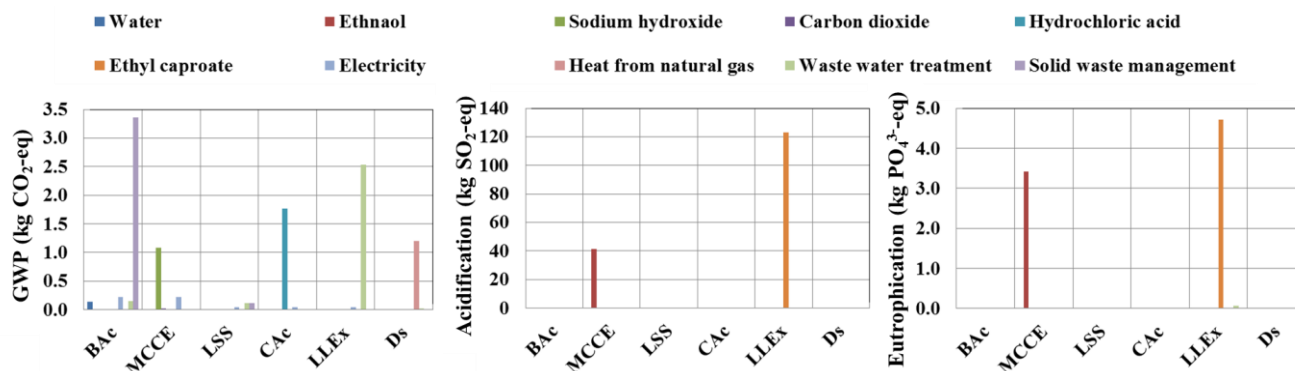

Figure 4: The environmental impact of each process involved in caproic acid production in the MCCE-biorefinery for the selected impact categories: Global Warming Potential (GWP), acidification and eutrophication. See Figure 29 for explanations of other abbreviations

#### 4. References

- [1] Grootcholten TIM, Strik DPBTB, Steinbusch KJJ, Buisman CJN, Hamelers HVM. Two-stage medium chain fatty acid (MCFA) production from municipal solid waste and ethanol. 2014;116:223-9.
- [2] Agler MT, Spirito CM, Usack JG, Werner JJ, Angenent LT. Chain elongation with reactor microbiomes: Upgrading dilute ethanol to medium-chain carboxylates. *Energy and Environmental Science*. 2012;5(8):8189-92.
- [3] Steinbusch KJJ, Hamelers HVM, Plugge CM, Buisman CJN. Biological formation of caproate and caprylate from acetate: Fuel and chemical production from low grade biomass. *Energy and Environmental Science*. 2011;4(1):216-24.
- [4] Agler MT, Wrenn BA, Zinder SH, Angenent LT. Waste to bioproduct conversion with undefined mixed cultures: the carboxylate platform. *Trends in Biotechnology*. 2011;29(2):70-8.
- [5] Bagby MO, Johnson RW, Daniels RW, Contrell RR, Sauer ET, Keenan MJ, et al. Carboxylic Acids. *Kirk-Othmer Encyclopedia of Chemical Technology*: John Wiley & Sons, Inc.; 2000.
- [6] Grootcholten TIM. Development of a mixed culture chain elongation process based on municipal solid waste and ethanol [PhD Thesis]: Wageningen University; 2013.
- [7] Steinbusch K. Liquid Biofuel Production from Volatile Fatty Acids [PhD thesis]: Wageningen University; 2010.
- [8] Weidema BPB, Ch.; Hischer, R.; Mutel, Ch.; Nemecek, T.; Reinhard, J.; Vadenbo, C.O.; Wernet, G. The ecoinvent database: Overview and methodology, Data quality guideline for the ecoinvent database version 3. Zurich, Switzerland: Ecoinvent; 2013.

# Recovery of waste streams from agroindustry through industrial symbiosis in Sicilia

Laura Cutaia<sup>1</sup>, Marco La Monica<sup>2</sup>, Claudia Scagliarino<sup>3</sup>, Grazia Barberio<sup>1</sup>, Silvia Scaffoni<sup>1</sup>,

Antonella Luciano<sup>1</sup>, Erika Mancuso<sup>1</sup>

<sup>1</sup>ENEA, Via Anguillarese 301, 00123 Roma (IT)

<sup>2</sup>University of Viterbo “La Tuscia”, Via San Camillo de Lellis, Viterbo (IT)

<sup>3</sup>Freelance environmental engineer

E-mail contact: [laura.cutaia@enea.it](mailto:laura.cutaia@enea.it)

## 1. Abstract

*Industrial Symbiosis can be considered as a strategy for sharing and valorising resources (including materials, energy, water, assets, expertise, logistics, capacity, equipments) between companies, so that a non-product produced by an industry can be used as an input by someone else (synergy). ENEA (Italian National Agency for New Technologies, Energy and Sustainable Economic Development) in 2011 started the project “Ecoinnovation Sicily” for the development of the first Italian Industrial Symbiosis Platform (Platform) to be implemented in Sicilia Region (among many other issues). The Platform addressed, in particular, to small and medium enterprises (SMEs) and other local stakeholders, offers many other tools, beyond the industrial symbiosis, useful for supporting industries for the eco-innovation. This paper explains the methodology for the identification of potential synergies and the pathways for their actual implementation, with the specific focus on streams coming from agroindustry.*

## 2. Introduction

The industrial simbyosis (IS) approach reflects the recent European strategies (EU COM, 2011, 2012, 2014) of decoupling economic growth, environmental impacts and natural resource consumption. There is a growing interest towards IS since it boost the resource efficiency, enhance the circular economy and fosters the eco-innovation. Different IS models can be applied, e.g. following the network approach or the industrial park one (like e.g. Kalundborg) (Chertow, 2004; Lombardi and Laybourn, 2012). Through IS the closure of resources cycle can be realised switching from an open system, where non-products are wasted, to a closed one where non-products have added-value destinations, in a Life Cycle Thinking perspective. ENEA in 2011 started the project “Ecoinnovation Sicily” for the development of the first Italian Industrial Symbiosis Platform to be implemented in Sicilia Region (among many other issues) (Cutaia et al, 2014). The Platform, addressed, in particular, to small and medium enterprises (SMEs) and other local stakeholders, offers many other tools, beyond the industrial symbiosis, useful for supporting industries for the ecoinnovation (regulatory database, simplified tools for LCA and Ecodesign, Best practices database, GIS system) (Cutaia et al, 2015 a-b). The ENEA platform started creating a network among companies, willing to share resources. . Waste and residues from one company can become resources in input for one other company (or companies), in short they can realise a “synergie”. During three operative meetings, about 90 participating companies have shared more than 400 input-ouput data (resources requested as input or available as output). These data, geo-referred and elaborated by ENEA, allowed the identification of more than 600 potential synergies between participating companies. Resource streams have been classified in 6 categories: 1) paper and cardboard products; 2) excavation materials, construction/demolition waste; 3) plastics/plastic products;

4) metals/metal products; 5) equipment; 6) waste/by-products from agroindustry (agriculture, exhausted vegetable oils, food products, bio-materials from livestock and fisheries). The last one is focused in this paper.

### 3. Population of database and recruitment of companies

The first step of the implementation of IS in Sicily concerns companies recruitment, started by creating a regional companies database. First steps of the project have been addressed at networking and promoting activities at regional level (in Sicily) and at national and international level too (Cutaia et al, 2015c). After, 3 operative meetings took place in Sicily, as summarised in Table 1.

	COMPANIES	DELEGATES	SHARED RESOURCES	POTENTIAL SYNERGIES IDENTIFIED DURING MEETINGS
SIRACUSA 1 (28/03/2014)	36	44	+200	+160
CATANIA (24/10/2014)	36	42	+200	500
SIRACUSA 2 (4/11/2014)	11	12	29	0

Table 1: Operative meetings held in Sicily in 2014. Summary of results.

Collected data were uploaded on the ENEA IS platform (Cutaia et al., 2015a-b), georeferenced and elaborated, so new potential synergies have been identified, in addition to those identified during the operative meetings. Resources have been classified as: materials; energy; expertise or consultancy and service; logistics and transports; capacity and equipment.

### 4. Industrial symbiosis for waste and byproducts from agroindustry in Sicily

The agro-industry sector in Sicily plays an important role in the regional and national economy. The impact of agriculture on the regional economy is 3.6%, resulting slightly higher than the average in south Italy (3.1%) and the national average (1.8%), and absolutely one of the highest in Italy (after Basilicata, Molise and Calabria). According to the 6th ISTAT Census of Agriculture, Sicily is the second region in Italy, after Puglia, for the number of farms, 219,677 in 2010 (13.6% of the total). According to the 9th ISTAT Census of industry and services, the food industry and beverage industry in Sicily has 6,828 active businesses, which account for 30.2% of the active companies in the manufacturing sector of the island. This quota is the highest in Southern regions (24.5%) and in Italy as well (13.7%).

Among the category “materials”, shared resources identified as “waste and byproducts from agroindustry” generated 50 synergies between 21 companies with different size and core business and different types of streams (fruit and vegetable scraps, wood cuttings, pasteurized milk whey). For these waste streams, different options of treatment and recovery have been investigated. The detailed analysis of these synergies has led to the identification of three main final destinations: energy recovery (3 synergies between 4 companies), material recovery for compost production (14 synergies between 9 companies) and material recovery for livestock feed production (9 synergies between 5 companies). The pathways of these synergies have been summarized in layouts. The symbiosis pathway on “energy recovery from scraps from agro-industry” has been sub-divided in: Anaerobic digestion for biogas production, characterized by scraps with a high content of organic substance that affects the rate of degradation of the substrate such as citrus scrap,

vegetables scrap, fruit scrap, peel of citrus fruit, pasteurized milk whey; Pyrolysis, which includes scraps with a lower calorific value very high such as wood cuttings of olive, vines, almonds and carob trees; grape and olive pomace, grape marc and dregs; table-grapes scrap processing.

Using data provided by participating companies, literature and technical data, it was possible to characterize those streams according to the characteristics required for the two treatment systems (biogas and pyrolysis plant), both for the characteristics of the product in input to the processes, and both for the outgoing one, for every step of the synergy's layout. In this way each potential synergy has been identified and tracked from the point where the scrap is produced to the product obtained. The layout of "livestock feed production from agro-industrial scraps" involves 4 Sicilian companies of three different provinces: 3 companies that give resources as output (mainly citrus pulp, named "pastazzo") and one that requires resources as input. Enea has identified 7 potential synergies between the 4 companies.

## 5. Discussion and conclusion

Two Operative Handbooks on the symbiosis pathways for the energy recovery and livestock feed production from waste agri-food have been realised by ENEA to summarize the synergies and their main issues. Concerning the symbiosis pathway on *energy recovery*, the quantity and availability make these scraps very interesting, both from an environmental and economic point of view. As some of these resources are landfilled, with very high costs and impacts, ENEA has highlighted that there are no obstacles for their utilisation, neither legal, as these scraps can be classified as byproducts and not as waste, nor technical, based on the characteristics required for the two plants. One concern comes from their seasonal availability; therefore the feeding of the plants must be assured by a set of organic scraps and waste streams available throughout all the year. A second major concern comes from the distances between the scraps' production sites and the plant, that can influence the cost of transport and the consequently the economic feasibility of the synergy. Concerning the *livestock feed production*, two regulatory aspects are relevant: the regulation on citrus pulp (Italian Law, 2013) has clearly recognized it as a byproduct of citrus useful for livestock use, taking it away permanently from waste legislation; European regulation on citrus pulp as feed materials on livestock feed (EU 68/2013) and regulatory requirements must be met before the feed livestock can be placed on the market.

Industrial Symbiosis approach redefines the waste concept by breaking the traditional meaning; the operative meetings represented an opportunity for participating companies to give a new meaning to their waste, to be considered as precious resources, which can be shared with other companies with mutual benefit. A proactive approach from involved companies is crucial for enhancing the possibilities of finding synergies between companies: the more they share information on their resources, the more matches between companies can be found through the implementation of the industrial symbiosis platform.

Industrial symbiosis platform could be used as a planner, if its dataset covers a region or a defined area, since it could allow the identification of recoverable and reusable waste streams in that area, attracting sustainable inward investment (overcoming magnitude problems, if any). Moreover, companies move their mind toward sharing concepts (at the base of sharing economy) and cooperative approach.

In this sense IS is a powerful tool for ecoinnovation at systemic level considering not only economic benefits and environmental advantages but also social issues and long-term culture change for companies, that are the way for the transition to green economy.

## 6. References

- [1] EU COM, (2011), Roadmap to a Resource Efficient Europe; EU COM, (2012), European Resource Efficiency Platform (EREP). Manifesto & Policy Recommendations, European Commission; EU COM, (2014), Towards a Circular Economy: A Zero Waste Programme for Europe.
- [2] Chertow M.R., (2004), Industrial Symbiosis, In: The Encyclopedia of Earth, Lifset R. (Ed.)
- [3] Lombardi R., Laybourn P., (2012), Redefining industrial symbiosis, *Journal Industrial Ecology*, 16, 28-37
- [4] Cutaia et al., (2014), "The Project for the Implementation of the Industrial Symbiosis Platform in Sicily: The Progress after the First Year of Operation" in: "Pathways to Environmental Sustainability. Methodologies and Experiences", Salomone, R., Saija, G. (Eds.), Springer International Publishing.
- [5] Cutaia et al., (2015a) *Environmental Engineering and Management Journal*, Vol.7, 14/2015 in press.
- [6] Cutaia et al., (2015b) "A systematic methodology for industrial symbiosis approach development at a regional scale", Proceedings of IWWATV 2015 Conference.
- [7] Cutaia et al., (2015c) "Comparison between networking approaches for industrial symbiosis projects ongoing in Italy" Book of abstracts ISIE Conference 2015 University of Surrey, Guildford 7th-10th July.
- [8] Italian National Institute of Statistics, (2011) "9th Census of industry and services" ISTAT (2011), On line at: <http://censimentoindustriaeservizi.istat.it/>.
- [9] Italian Law n. 98/2013, art. 41- quater Converting, with amendments, Law 21 June 2013, n. 69.
- [10] Commission Regulation (EU) No 68/2013 of 16 January 2013 on the Catalogue of feed materials Text with EEA relevance

# Environmental impact of using specialty feed ingredients in pig and broiler production: A life cycle assessment

Alexander Liedke<sup>1</sup>, Michael Binder<sup>2,3</sup>, Ermias Kebreab<sup>4</sup>, Matthias Finkbeiner<sup>5</sup>, Sabine Deimling<sup>1</sup>

<sup>1</sup>*thinkstep AG, Hauptstraße 111-113, 70771 Leinfelden-Echterdingen, Germany*

<sup>2</sup>*Evonik Industries AG, Rodenbacher Chaussee 4, 63457 Hanau-Wolfgang, Germany*

<sup>3</sup>*Chairman of working group at International Feed Industry Federation (IFIF) and the European Union Association of Specialty Feed Ingredients and their Mixtures (FEFANA)*

<sup>4</sup>*Department of Animal Science, University of California, Davis, CA 95616, USA*

<sup>5</sup>*Department of Environmental Technology, TU Berlin, Strasse des 17. Juni 135, D-10623 Berlin, Germany*

*E-mail contact: Alexander.Liedke@thinkstep.com*

## 1. Abstract

*A LCA according to ISO 14040/44 analysed the production of 1 ton live weight (LW) pigs and 1 ton live weight broilers at the farm gate. Three different alternatives were analysed for Europe, North America and South America: Standard base diet without any specialty feed ingredient (SFI) supplementation, supplemented with amino acids only, and supplemented with amino acids and phytase. SFI supplementation in pig and broiler diets reduced greenhouse gas emissions (cradle-to-farm gate) by 56 and 54% in Europe, 17 and 15% in North America and 33 and 19% in South America, respectively, compared to an unsupplemented diet. When direct land use change was considered, the benefits were much greater. Overall, SFI supplementation substantially reduced the global warming, eutrophication and acidification potentials in all regions studied.*

## 2. Introduction

Livestock production is expected to double by 2050 (Garnett, 2009). Livestock sector significantly contributes to global environmental change. In pig and poultry production, the impact to the environment is mainly from (i) excretion of excess nitrogen (N) and phosphorus (P) leading to the deterioration of aquatic systems (Conley et al., 2009), (ii) direct greenhouse gas (GHG) emissions from manure storage and application to the field, which contributes to climate change (Tubiello et al., 2013), and (iii) ammonia emissions responsible for acidification and eutrophication of N-limited ecosystems (Sutton et al., 2008).

Formulating diets with only natural feedstuffs to meet requirements results in large excess of amino acids (NRC, 2012). Similarly, a considerable amount of P in pig and poultry diets is unavailable to the animal (Kebreab et al., 2012). Reducing intake of protein and P is the most effective way to reduce environmental impacts, however, this has to be achieved without impairing animal performance or negative environmental impact. The supplementation of animal feed with the enzyme phytase improves the availability and digestibility of organically bound plant P leading to reduced use of inorganic P in feed formulation and subsequent decrease in P excretion (Kebreab et al., 2012). The production of specialty feed ingredients (SFI) such as supplemental amino acids and phytase also has an environmental footprint. This study assesses the impact of multiple use of SFI on the environmental impact of all stages in pig and poultry production with cradle-to-farm gate life cycle assessment study of pig and broiler production and compares strategies with and without SFI supplementation.



### 3. Method

The LCA study was performed with GaBi LCA software and databases in accordance to ISO 14040/ 14044 and critically reviewed by a review panel. The functional unit was considered to be 1 ton of animal live weight (LW). The livestock husbandry systems represent typical conventional large-scale production systems in the 3 regions Europe, North America, and South America. Each production system was divided into 5 processes: production of base feed ingredients, production of specialty feed ingredients, preparation of feed, animal husbandry and manure management.

Three alternatives for each region in the study were analyzed. The alternatives were (i) standard base diet without any specialty feed ingredient supplementation (A1), (ii) standard base diet supplemented with crystalline amino acids only (A2), and (iii) standard base diet supplemented with crystalline amino acids and phytase (A3). Both production systems are influenced by the level of feed conversion ratio (FCR). In addition to the 3 alternatives, 5 scenarios for each region and each production system were investigated to assess potential improvements in the pig and poultry sectors and their environmental implications (Figure 1). Different base feed ingredients and fed phases in the regions are considered. Diets for pigs in North and South America were formulated based on NRC (2012) and for pigs in Europe the InraPorc model was used (Van Milgen et al., 2008). The first limiting amino acids for pigs are lysine, threonine and tryptophan, and for broilers, methionine, lysine and threonine are first limiting (Tokach and DeRouchey, 2012). Amino acid requirements were assessed based on standardized ileal digestibility for both pigs and broilers because it represents the best available method for routine evaluation of amino acid bioavailability in feedstuffs (NRC, 2012). Apparent fecal digestibility is used to assess P availability for both poultry and pigs.

Data for base feed ingredients are taken from GaBi databases (GaBi 2014) and are modelled with the GaBi agrarian model (Liedke et al., 2014). Based on Flynn et al. (2012), an average annual land use change emission factor of 34.8 t CO<sub>2</sub> eq/ha for South America was applied. The emissions from direct land use change per hectare soybeans cultivated are calculated by multiplying the emission factor of South America with the area applicable to LUC. This calculation results in annual direct LUC emissions of 18.4 t CO<sub>2</sub> eq/ha for soybeans cultivated in Brazil. With estimated annual yield of 2.7 t/ha, 1 kg of soybeans bears an environmental impact of 6.8 kg CO<sub>2</sub> eq/kg, which leads to global warming impacts of 6.2 kg CO<sub>2</sub> eq/kg of soybean meal and 16.1 kg CO<sub>2</sub> eq/kg of soybean oil. The production of the amino acids lysine, threonine and methionine is modelled according to Mosnier et al. (2011) and Garcia-Launay et al. (2014). For phytase input details from Nielsen et al., (2007) were used for modelling. Feed preparation in a feed mill is assumed for this study (based on Pelletier (2008)).

Manure management, which includes manure storage and field application was considered. Methane emissions from manure were calculated according to IPCC (2006). Ammonia and nitrous oxide emissions were calculated based on Rigolot et al . (2010), IPCC (2006) and Dammgen et al. (2013). For manure applied on the field a credit is given according to the amount of nitrogen available for plant uptake. Nitrogen excretion is calculated as the difference between nitrogen uptake and nitrogen retention. The uptake is calculated based on the crude protein content in the animal feed, final weight and the feed conversion ratio. P emissions was modelled based on Nielsen et al. (2007).

CML impact assessment methodology framework (version 3.9, November 2010) was selected for this assessment. The environmental indicators or impact assessment categories considered in this study were global warming potential (GWP), eutrophication potential (EP), acidification potential (AP), and primary energy demand fossil (PED).

#### 4. Results

Figure 1 shows exemplarily the results for GWP for pigs and broiler in Europe. The results are also available for AP, EP, PED for pigs and broiler in Europe, North- and South America.

Specialty feed ingredient supplementation in pig and broiler diets reduced greenhouse gas emissions (cradle-to-farm gate) by 56 and 54% in Europe, 17 and 15% in North America and 33 and 19% in South America, respectively, compared to an unsupplemented diet. When direct land use change was considered, the benefits were much greater due to reduced demand of soybean meal in European and South American diets. The eutrophication potential of unsupplemented diets was up to 165% in pig and 253% in broiler production systems compared to supplemented alternatives. The acidification potential of supplemented strategies was reduced by up to 30% in pig and 79% in the broiler production system. The primary energy demand was similar in all alternatives.

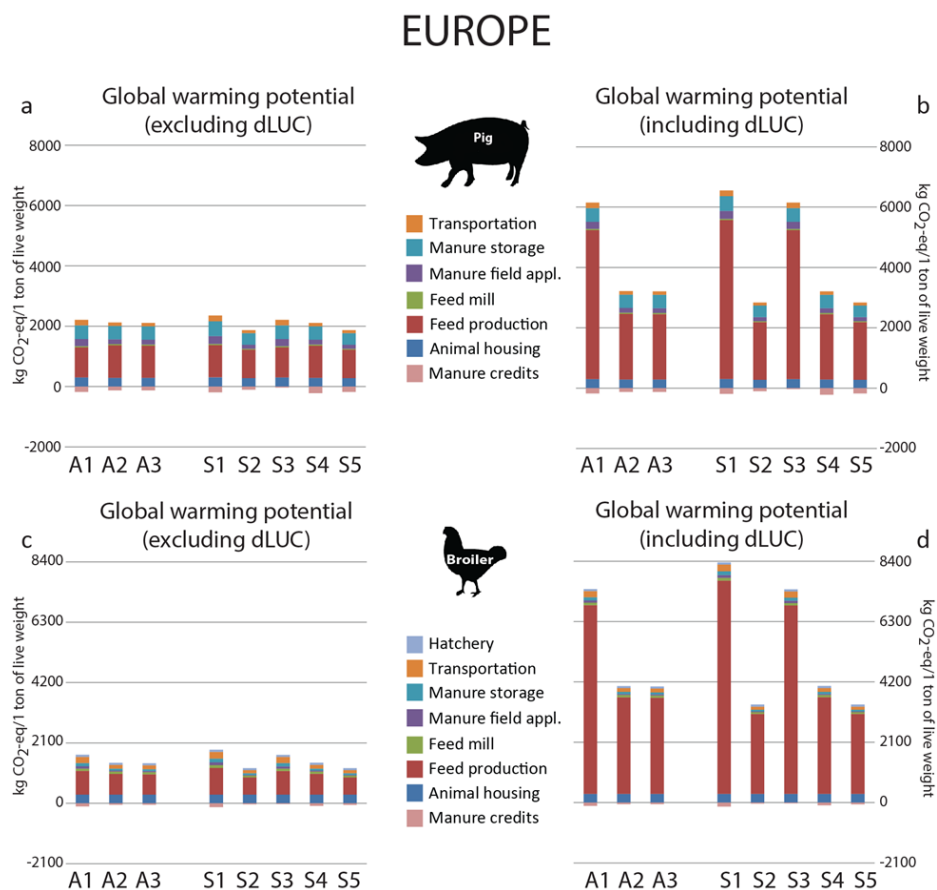

Figure 1: GWP impact assessment in European pig and broiler production systems, with and without dLUC emissions. (A1) standard base diet, (A2) supplemented with AA, (A3) supplemented with AA and phytase. (S1) A1 with a higher feed conversion ratio (FCR), (S2) A3 with a lower FCR, (S3) A1 with no manure N credits, (S4) A3 with 100% manure N credits, (S5) A3 with low FCR and 100% manure credits.

## 5. Conclusion

Using SFI such as AA or phytase in livestock production can significantly contribute to the sustainability of substantially growing livestock production. This was shown for three different regions. By connecting the animal feed composition with animal performance and comparing identical functional units, the study identified and underlined the environmental improvement potentials which can be achieved by changing animal diets from without any supplementation to supplemented diets for different global regions.

## 6. References

- [1] De Vries, M., and De Boer, I.J.M., 'Comparing environmental impacts for livestock products: a review of life cycle assessments'. *Livest. Sci.*, 128 (2010) 1-11.
- [2] Garcia-Launay, F., van der Werf, H.M.G., Nguyen, T.T.H., Le Tutour, L., and Dourmad, J.-Y., 'Evaluation of the environmental implications of the incorporation of feed-use amino acids in pig production using Life Cycle Assessment' *Livest. Sci.* 161 (2014) 158–175
- [3] Flynn, H.C., Canals L.M.I., Keller, E., King, H., Sim, S., Hastings, A., Wang, S.F., and Smith, P., 'Quantifying global greenhouse gas emissions from land-use change for crop production'. *Global Change Biol.* 18 (2012) 1622-1635.
- [4] GaBi Database & GaBi Agrarian principles & GaBi Modelling Principles. Thinkstep AG (formerly PE INTERNATIONAL AG). <http://database-documentation.gabi-software.com/deutsch/support/gabi/gabi-modelling-principles>. Accessed on Apr. 10, 2015.
- [5] Garnett, T., 'Livestock-related greenhouse gas emissions: impacts and options for policy makers.' *Environ. Sci. Policy.* 12 (2009) 491-503.
- [6] IPCC, 'IPCC guidelines for national greenhouse gas inventories'. Institute for Global Environmental Strategies, Hayama, Japan (2006).
- [7] Kebreab, E., Hansen, A.V., and Strathe, A.B., 'Animal production for efficient phosphate utilization: from optimized feed to high efficiency livestock'. *Curr. Opin. Biotechnol.* 23 (2012) 872-877.
- [8] Liedke, A., Deimling, S., Rehl, T., Bos, U., Brandstetter, P., and Baitz, M., 'Feed and Food Databases in LCA – an example of implementation'. *Proceedings of the 9th International Conference on Life Cycle Assessment in the Agri-Food Sector* (2014)
- [9] Mosnier, E., van der Werf, H.M.G., Boissy, J., and Dourmad J.-Y., 'Evaluation of the environmental implications of the incorporation of feed-use amino acids in the manufacturing of pig and broiler feeds using Life Cycle Assessment'. *Anim.* 5 (2011) 1972–1983.
- [10] Nielsen, P.H., Oxenbøll, K.M., and Wenzel H., 'Cradle-to-Gate environmental assessment of enzyme products produced industrially in Denmark by Novozymes A/S'. *Int. J. LCA* 12 (2007) 432 – 438.
- [11] NRC. 'Nutrient requirements of swine'. 11th rev. ed. Natl. Acad. Press, Washington, DC. (2012)
- [12] Pelletier, N., 'Environmental performance in the US broiler poultry sector: Life cycle energy use and greenhouse gas, ozone depleting, acidifying and eutrophying emissions'. *Agric. Syst.* 98 (2008) 67-73.
- [13] Rigolot, C., Espagnol, S., Pomar, C., and Dourmad, J.-Y., 'Modelling of manure production by pigs and NH<sub>3</sub>, N<sub>2</sub>O and CH<sub>4</sub> emissions. Part I: Animal excretion and enteric CH<sub>4</sub>, effect of feeding and performance' *Anim.* 4 (2008) 1401-1412.
- [14] Sutton, M.A., Erisman, J.W., Dentener, F. and Moller, D., 'Ammonia in the environment: From ancient times to the present'. *Environ. Poll.* 156 (2008) 583–604.
- [15] Tokach, M., and DeRouchey, J., 'Feeding swine and poultry low protein diets with feed-use amino acids and the effect on the environment'. Ajinomoto Heartland Inc., Chicago, USA (2012)
- [16] Tubiello, F.N., Salvatore, M., Rossi, S. et al., 'The FAOSTAT database of greenhouse gas emissions from agriculture'. *Environ. Res. Letters* 8 (2013)
- [17] Van Milgen, J., Valancogne, A., Dubois, S., Dourmad, J.-Y., Sevé, B., and Noblet, J., 'InraPorc: A model and decision support tool for the nutrition of growing pigs'. *Anim. Feed Sci. Technol.* 143 (2008) 387-405.

# Alternative scenarios of food-waste treatment: a comparative Life Cycle Assessment

Salomone R., Saija G., Ioppolo G., Pirilli M., Mondello G.

University of Messina, Dep.t of Economics, Business, Environment and Quantitative Methods

E-mail contact: [roberta.salomone@unime.it](mailto:roberta.salomone@unime.it)

## 1. Abstract

*Food-waste is a significant environmental problem in Western countries; FAO (2011) estimates that the amount produced worldwide is about 1.3 billion tonnes per year, equivalent to about one third of the total production of food intended for human consumption. The growing awareness of the need for sustainable strategies for food-waste management is driving an increase in Life Cycle Assessment (LCA) research activities in this sector. This paper presents the results of a comparative LCA of five different alternative scenarios of food-waste treatment (landfill; incinerator; composting; production of biogas; and valorisation of valuable fractions for feed production) produced by a mass retail company operating in Messina (Italy).*

## 2. Introduction

The growing awareness of the need for sustainable strategies for food waste (FW) management is driving an increase in research activities in this sector oriented to waste prevention (probably the best solution) and waste treatment/valorization. Among these studies, particular attention is given to the estimation of environmental impacts, in a life cycle perspective, related to the production of FW and its possible treatment scenarios. Indeed, in order to fully understand how to phase out landfilling and to obtain a minimisation of FW, comparative Life Cycle Assessment (LCA) studies on different FW management techniques (both disposal and recycling) are highly necessary and should be increased. In this context, this paper presents the results of a comparative LCA of five different alternative scenarios of FW treatment (landfill; incinerator; composting; production of biogas; and dry feed production) produced by a mass retail company (MRC) operating in the Province of Messina (Italy).

## 3. Methods and main results

### 3.1 Goal and scope of the study

The study here presented is part of the research project Smart Cities and Communities and Social Innovation - Project ABSIDE, Cod. PON04a2\_F, Subsystem BE & SAVE. One of the research actions of the project (N. 3b.1.7.3), in which the authors of this paper are involved, is to assess the environmental impact of alternative potential scenarios for the management of FW produced by a MRC operating in Messina (Italy). The analysed scenarios include: **1) LF-Landfill** (FW is collected and disposed in landfill with energy recovery from biogas); **2) IN-Incineration** (FW is collected and disposed in an incineration plant with energy recovery); **3) CO-Compost** (FW is collected, transported to a de-packing plant, and the organic fraction is treated in a composting plant); **4) BG-Biogas** (this scenario differs from 3) only for the organic fraction sent to a biogas production plant); **5) FE-Feed** (in this case the organic fraction is treated in order to obtain dry feed). The scope of the study is to identify the scenario/s with lower environmental impacts and to select the one for which to design sustainable management practices. The system boundaries include all the direct and indirect activities involved in the management of FW produced by the investigated MRC, from FW

collection at the supermarkets to its final disposal: **collection** (collection of FW from the supermarkets of the MRC and transport to the storage site/de-packing plant); **pre-treatment** (de-packing of FW); **treatment** (treatment for the disposal/valorisation of FW). Recycling of packaging materials is excluded from system boundaries. Allocation rules were avoided by expanding system boundaries, including by-products obtained in the different treatment processes (by-products are considered as avoided products: there is an avoided production of fuels, fertilizers, or other materials, and thereby a negative contribution to the environmental impact deriving from the corresponding scenario). A functional unit (FU) of 20 tonnes of organic waste per year was considered.

### 3.2 Life Cycle Inventory Analysis (LCI)

Data sources, as well as main inputs and outputs, are summarized in table 1.

		Unit	Scenario					Data source
			1 (LF)	2 (IN)	3 (CO)	4 (BG)	5 (FE)	
<i>Input data</i>	Transport	tkm	1,813	532	400	400	400	Measured: [1]
	Electricity	MJ	4,125	3,974	10,454	6,422	5,768	Calculated: [1;2;3;4;5]
	Heat	MJ	-	732	-	-	-	Calculated: [1;2]
	Natural gas	m <sup>3</sup>	-	-	-	-	616	Calculated: [4;7]
	Diesel	kg	-	-	11	-	-	Calculated: [3;7]
	Diesel	MJ	529	-	-	-	-	Calculated: [2;7]
	Water	L	-	3,214	2,400	1,320	51	Calculated: [1;2;3;4]
<i>Output data</i>	Electricity	MJ	6,103	49,227	-	-	-	Calculated: [2;6]
	Compost	kg	-	-	4,200	4,400	-	Calculated: [3]
	Biogas	Nm <sup>3</sup>	-	-	-	1,700	-	Calculated: [3]
	Dry feed	kg	-	-	-	-	2,600	Calculated: [4]
<i>Avoided products</i>	Electricity	MJ	6,103	49,227	-	-	-	Calculated: [2;6]
	Urea	kg	-	-	180	188	-	Calculated: [1;3]
	Natural gas	Nm <sup>3</sup>	-	-	-	1,020	-	Calculated: [7;8]
	Soy Meal	kg	-	-	-	-	1,018	Calculated: [7;9]

Table 1: Main input/output data and sources per FU (20 tonnes of organic waste per year)

Primary data were collected in the supermarkets through questionnaires, interviews, and sampling of FW and its packaging, considering vegetable waste as a representative sample of the organic fraction. Indeed, vegetable waste represents the major part of the FW produced by the investigated organization (more than the 47%) and, for simplification, it was assumed that there is not differentiation in the composition of FW treated in the different scenarios.

### 3.3 Life Cycle Impact Assessment (LCIA)

CML 2 baseline 2000 method [10] was chosen as impact assessment methodology. System scenarios were analysed with SimaPro 8 software [11]. Impact categories chosen for the assessment were: Acidification Potential (AP), Eutrophication Potential (EP), Global Warming Potential (GWP), Ozone Depletion Potential (ODP), and Photochemical ozone creation (POCP). LCIA results are summarised in table 2 (characterisation) and figure 1 (normalisation).

Impact categories	Unit	Scenario				
		1 (LF)	2 (IN)	3 (CO)	4 (BG)	5 (FE)
AP	kg SO <sub>2</sub> eq	3,08E+00	3,30E+01	7,56E+00	1,91E+00	9,54E+00
EP	kg PO <sub>4</sub> <sup>---</sup> eq	1,12E+00	6,45E+00	1,41E+00	3,35E-01	1,06E+01
GWP100	kg CO <sub>2</sub> eq	1,39E+04	2,11E+04	1,19E+03	1,70E+02	2,78E+03
ODP	kg CFC-11 eq	1,40E-04	5,26E-04	1,19E-04	-5,61E-06	-3,82E-05
POCP	kg C <sub>2</sub> H <sub>4</sub> eq	2,69E+00	5,75E-01	2,65E-01	7,03E-02	3,88E-01

Table 2: LCIA characterisation results (CML 2 baseline 2000 V2.05 World, 1990)

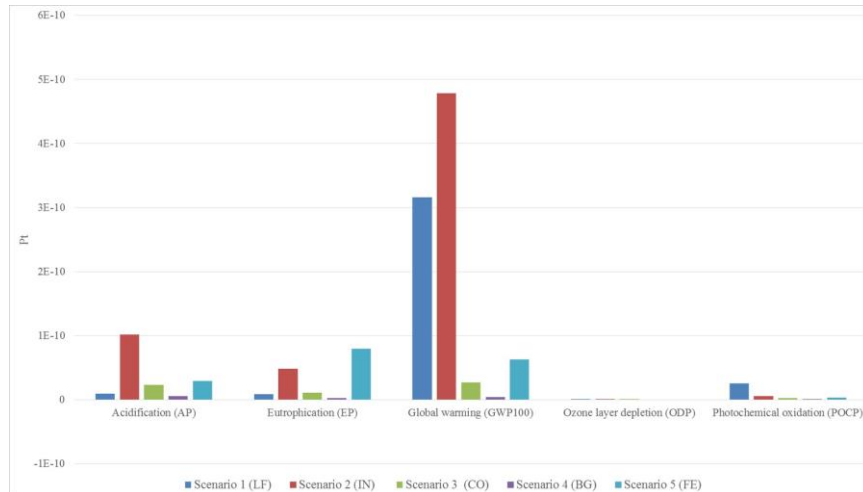

Figure 1: LCIA normalisation results (CML 2 baseline 2000 V2.05 World, 1990)

#### 4. Interpretation, discussion and conclusive remarks

Among the considered scenarios, the major environmental impacts are attributable to the scenarios incinerator and landfill, in particular for GWP respectively 21,066 kg and 13,931 kg CO<sub>2</sub> eq., while the best environmental performance is connected to the scenario biogas (GWP 169.85 kg CO<sub>2</sub> eq.). Normalisation results highlight that for the categories AP and GWP major impacts are caused by the scenario incinerator (respectively with values equal to 1.02E-10 and 4.78E-10 Pt), for ODP and POCP by the scenario landfill (respectively with values equal to 2.58E-11 and 4.6E-13 Pt) and for EP by the scenario dry feed (7.97E-11 Pt). The scenario biogas confirms its lower impact relative to the other considered scenarios, for each of the analysed categories.

A sensitivity analysis was conducted taking into consideration the scenarios 1, 2, 3 and 4 (as for the dry feed treatment no inventory data was found on available dedicated databases) with the purpose to verify the robustness of the results. In the sensitivity analysis data sources for treatment processes were modified using data from dedicated databases. The analysis confirmed that the major environmental impacts can be attributed to the landfill and incinerator scenarios, while the best impact is associated with the production of biogas.

The biogas scenario was therefore selected to carry out an in-depth analysis oriented to the identification of its potential applicability by the local MRC investigated. The analysis allowed to identify the following key choices, as more consistent with the characteristics of the case study: use of anaerobic micro-digesters or domestic digesters; thermophilic anaerobic digestion (dry technique) with an operating temperature of about 35 °C and a duration of 30 days; use of two parallel digesters of 2 m<sup>3</sup> each with a solar heating system.

In addition to the environmental benefits already highlighted with the LCA analysis, the economic benefits associated with these key choices can be summarized as follows: a) low initial investment costs (200 €/digester, in addition to the construction costs of installation and authorization), low start up costs (immediate) and management (no need of specialized personnel), with payback within a year; b) ability to integrate the phases of FW transport within the existing logistic organisation; c) energy valorisation of waste: 4,000 kg/year of biomethane for a savings on gas bill of 5,000 €/year if used for heating; or savings higher than 9,000 €/year if used for the automotive sector (gasoline equivalent = 5,540 L); d) the digestate (about 13,320 kg/year) can be used as agricultural fertilizer which, shows superior qualities equivalent to compost; e) the system requires no special Italian environmental authorizations because it does not produce any impact on the landscape or the environment in general.

## 5. References

- [1] EcoinventCentre, 2007. Ecoinvent Data v2.0 Final Reports Ecoinvent. Swiss Centre for Life Cycle Inventories, Dübendorf, Switzerland, 2007.
- [2] Arena U., Mastellone M.L., Perugini F., 2003. The environmental performance of alternative solid waste management options: a life cycle assessment study, *Chemical Engineering Journal*, Volume 96, Issues 1–3, 15 December 2003, Pages 207-222, ISSN 1385-8947, <http://dx.doi.org/10.1016/j.cej.2003.08.019>.
- [3] Righi S., Oliverio L., Pedrini M., Buscaroli A., Della Casa C., 2013. Life Cycle Assessment of management system for sewage sludge and food waste: centralized and decentralized approaches. *Journal of Cleaner Production* 44(2013) 8-17.
- [4] Kim M.-H., Kim J.-W., 2010. Comparison through a LCA evaluation analysis of food waste disposal options from the perspective of global warming and resource recovery. *Science of the Total Environment* 408, 3998–4006.
- [5] Atritor Limited, 2015 Turbo Saparator, [www.turboseparato.co.uk](http://www.turboseparato.co.uk)
- [6] European Commission, 2007. European Commission European Reference Life Cycle Database (ELCD). European Commission. Directorate General Joint Research Centre (JRC).
- [7] Nielsen PH, Nielsen AM, Weidema BP, Dalgaard R., Halberg N., 2003. LCA food data base. [www.lcafood.dk](http://www.lcafood.dk)
- [8] Rosato M. 2012. Digestori domestici. Rifiuti per la produzione di biogas in casa e l'indipendenza energetica, <http://www.architetturaecosostenibile.it/architettura/criteri-progettuali/digestori-domestici-rifiuti-produzione-biogas-546/> (accesso il 11.05.2015).
- [9] CVB, 2010 Tabellenboek Veevoeding. CVB-reeks nr. 49 Productschap Diervoeder, Centraal Veevoederbureau, Den Haag, the Netherlands.
- [10] CML2 baseline 2000 Centre of Environmental Science, Leiden University, NL, 2000.
- [11] Prè Consultant, Simapro 8.0.2, Amersfoort, The Netherlands, 2014.

# Sustainable Management of EU Food Waste with Life Cycle Assessment

Simone Manfredi, Jorge Cristóbal, Cristina T. Matos  
European Commission, Joint Research Centre (JRC), Institute for Environment and Sustainability (IES),  
via Enrico Fermi 2749; 21027 Ispra (VA), Italy  
E-mail contact: [simone.manfredi@jrc.ec.europa.eu](mailto:simone.manfredi@jrc.ec.europa.eu)

## 1. Abstract

*Worldwide, about 1.3 billion tonnes of food are wasted every year, of which about 89 million tonnes were estimated for Europe, corresponding to almost 200 kg of food waste per capita. This leads to significant impacts on the environment. However, the estimation of magnitude of such impacts and the evaluation of the relative contributions to environmental impacts arising from specific life cycle stages or waste management technologies is not straightforward. By means of the software EASETECH, this work aims at modelling a number of relevant food waste management scenarios – from food waste generation to final treatment – in order to provide quantitative understanding of the overall environmental performance, as well as to identify the life cycle stages, technologies, technical and environmental factors that mostly influence such performance. This, in turn, will help identify options for improving the overall environmental performance of food waste management, while minimizing undesirable shifting of burdens.*

## 2. Introduction

Worldwide, over 1.3 billion tonnes of food for human consumption is wasted or lost annually [1] throughout the food supply chain (from agriculture production, transport, processing, distribution and consumption), which represents about 1/3 of the total world food production. In Europe, the 2014 estimates show up to 100 million tonnes of food waste per year [2], corresponding to approximately 200 kg per capita (considering a population of 503 million people in the EU27 in year 2014 Eurostat).

Such a massive generation of food waste leads to significant environmental impacts. For instance, worldwide figures provided by FAO [3] on the consequences of food produced for human consumption that had been lost or wasted include (in 2007): 3.3 Gtonnes of CO<sub>2</sub> eq. emitted to the atmosphere, 250 km<sup>3</sup> of surface and groundwater consumption (i.e.  $2.5 \cdot 10^{11}$  m<sup>3</sup>) and 1.4 billion hectares of land occupation.

## 3. Legislative and methodological background

To address these issues, Europe is committed in designing and implementing strategies and measures to improve the management of food waste and, at the same time, find solutions to prevent/reduce it. In 2011, the European Commission (EC) identified food waste as one of the main problems that needed to be addressed to increase resource efficiency [4] and invited all Member States (MS) to address food waste in their National Waste Prevention Programs. In 2014, the EC announced the intention of reducing generation of food waste of at least 30% by the end of 2025 compared to 2017 levels. This proposal was part of the Circular Economy package [5,6] but was withdrawn in February 2015 with the intention of replacing it by the end of 2015 with a more ambitious one to be integrated in a coherent package containing a wide range of other measures to increase the circularity of the European economy [2].



The Waste Framework Directive (2008/98/EC) does not include specific provisions on food waste, nor even a definition of what food waste is/includes. However, according to this directive measures shall be taken by MS to achieve environmental sound management of bio-waste by following the so-called “waste hierarchy” (art 4(1)). Such hierarchy considers waste prevention was identified as the most environmentally sound option (but no prevention targets were settled for bio-waste), while landfilling was considered as the worst option. The same directive, however, also allows to deviate from such hierarchy if Life Cycle Thinking (LCT) based evidence shows that deviating from the hierarchy results in lower environmental impacts.

Life Cycle Thinking (LCT) can be intended as a conceptual approach that aims at identifying improvements and lowering impacts of any goods / services at all stages of the life cycles. Life Cycle assessment (LCA) is as a transposition of LCT into quantitative terms. LCA – as defined by the ISO 14044 (ISO, 2006) is a decision support tool widely used to evaluate the environmental impacts arising from any goods / services.

#### 4. Objectives and general modelling approach

The work being conducted aims at evaluating the environmental performance (based on 14 impact categories proposed by the EC Environmental Footprint (EF) methodology [7] shown in table 1) of relevant food waste management scenarios and at identifying options for improvements of such performance. The LCA functional unit considered is management of 1 tonne of food waste from the moment food waste is generated. The LCA system boundaries thus comprise all relevant processes of the food waste management chain, including displacement of energy with the energy produced with food waste and replacement of chemical fertilisers with compost

Impact Category	Impact Assessment Model	Impact Category units
Climate Change	Bern model	kg CO <sub>2</sub> eq.
Ozone Depletion	EDIP model	kg CFC-11 eq.
Ecotoxicity for aquatic fresh water	USEtox model	CTUe*
Human Toxicity - cancer effects	USEtox model	CTUh**
Human Toxicity – non-cancer effects	USEtox model	CTUh**
Particulate Matter/Respiratory Inorganics	RiskPoll model	kg PM <sub>2.5</sub> eq.
Ionising Radiation – human health effects	Human Health effect model	kg U <sup>235</sup> eq. (to air)
Photochemical Ozone Formation	LOTOS-EUROS model	kg NMVOC eq.
Acidification	Accumulated Exceedance model	mol H <sup>+</sup> eq.
Eutrophication – terrestrial	Accumulated Exceedance model	mol N eq.
Eutrophication – aquatic	EUTREND model	fresh water: kg P eq. marine: kg N eq.
Resource Depletion – water	Swiss Ecoscarcity model	m <sup>3</sup> water used
Resource Depletion – mineral, fossil	CML2002 model	kg antimony (Sb) eq.
Land Transformation	Soil Organic Matter model	kg C (deficit)

\* Comparative Toxic Unit for ecosystems

\*\* Comparative Toxic Unit for humans

Table 1: Impact Categories in the EC EF methodology.

Towards this goal, the LCA-based modelling will be used to provide quantitative assessment of a comprehensive set of environmental impacts. The software EASETECH (Environmental Assessment System for Environmental TECHNOlogies) will be used to conduct such modelling exercise. EASETECH is an LCA-based model for assessment of environmental technologies developed by DTU-Environment [8]. It is designed to perform life-cycle assessment (LCA) of complex systems handling heterogeneous material flows.

As results of the work being conducted are not yet available, this extended abstract only presents the general modelling framework. A complete presentation and analysis of modelling results will be presented in the context of the EXPO LCA Food conference.

### 5. LCA modelling of food waste management scenarios: an overview

The food waste management scenarios will include the following stages of the value chain: collection, transport and treatment/disposal. The starting point for the modelling exercise will be the estimation of the composition of the waste generated (i.e. mass-based percentage of each material fraction that compose the food waste), based on real data for a selected region. A number of different scenarios will be developed and assessed with EASETECH, representing different combination of technologies for each stage of the food waste value chain (see Figure 1). For instance, modelling of food waste collection will consider several different collection schemes, e.g.: city center, single-family, multi-family and rural area.

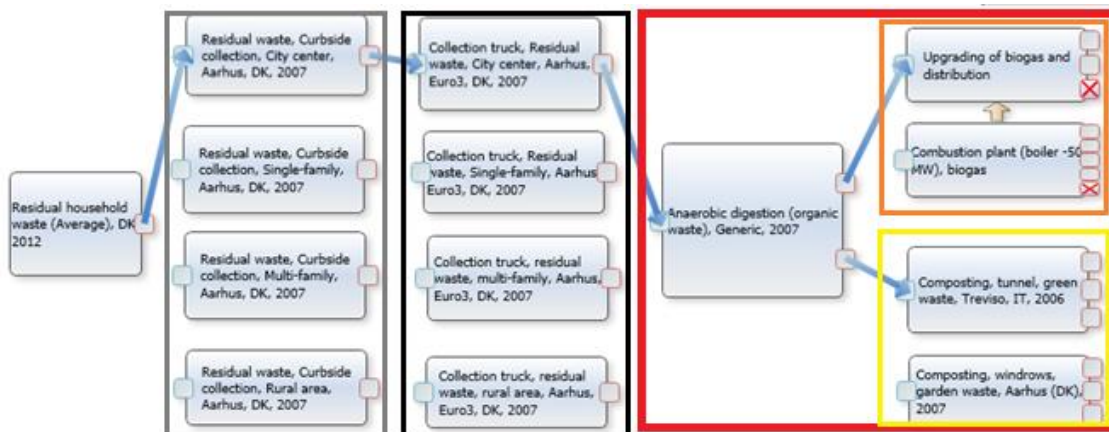

Figure 1: Examples of combinations of technological steps for inclusion in the LCA modelling

With respect to food waste treatment, the technologies that will be considered in the scenarios include: (1) anaerobic digestion (AD) with production of biogas used in the production of Combined Heat and Power (CHP) and composting of the digestate from the AD to produce compost, and (2) AD with production of biogas which is upgraded to biomethane used as transport fuel and composting of the digestate from the AD to produce compost.

## 6. References

- [1] Gustavsson, J., Cederberg, C., Sonesson, U., Otterdijk, R. and Meybeck, A. 'Global food losses and food waste – Extent, causes and prevention'. Food and agriculture organization of the United Nations, Rome (2011).
- [2] European Commission, [http://ec.europa.eu/food/safety/food\\_waste/index\\_en.htm](http://ec.europa.eu/food/safety/food_waste/index_en.htm)
- [3] 'Food wastage footprint, Impacts on natural resources' Food and agriculture organization of the United Nations, Rome (2014).
- [4] European Commission, Communication COM(2011) 571 Roadmap to a Resource Efficient Europe – Official Journal of the European Union (2011).
- [5] European Commission, Communication COM(2014) 397 proposal for a Directive of the European Parliament and of the Council amending Directives 2008/98/EC on waste, 94/62/EC on packaging and packaging waste, 1999/31/EC on the landfill of waste, 2000/53/EC on end-of-life vehicles, 2006/66/EC on batteries and accumulators and waste batteries and accumulators, and 2012/19/EU on waste electrical and electronic equipment Official Journal of the European Union (2014).
- [6] European Commission, Communication COM(2014) 398 Towards a circular economy: A zero waste programme for Europe (2014). This COM has been withdrawn in February 2015, after which new consultations have started towards developing a new proposal for a COM by the end of 2015.
- [7] European Commission (2013). RECOMMENDATION (2013/179/EU) on the use of common methods to measure and communicate the life cycle environmental performance of products and organisations, Annex II (Product Environmental Footprint (PEF) Guide).
- [8] Clavreul, J., Baumeister, H., Christensen, T.H., Damgaard, A., 2014. An environmental assessment system for environmental technologies. *Environ. Model. Softw.* 60, 18–30.

## How food loss is addressed in LCA

Sara Corrado<sup>1,2</sup>, Fulvio Ardente<sup>2</sup>, Serenella Sala<sup>2</sup>, Erwan Saouter<sup>2</sup>

<sup>1</sup>Università Cattolica del Sacro Cuore, Istituto di chimica agraria e ambientale,  
Via Emilia Parmense 84, 29122 Piacenza (PC), Italy

<sup>2</sup>European Commission, Joint Research Centre (JRC), Institute for Environment and Sustainability (IES),  
via Enrico Fermi 2749, 21027 Ispra (Va), Italy

E-mail contact: [sara.corrado@unicatt.it](mailto:sara.corrado@unicatt.it)

### 1. Abstract

*Life Cycle Assessment (LCA) methodology is at the core of quantifying the environmental impact of food loss and waste (FLW) and to identify pros and cons of the options for food loss minimisation and waste management or valorisation. However, dealing with food loss in LCA is a complex task and currently different approaches have been adopted. A lack of homogeneity has been observed, both at the methodological level and in the choice of inventory data.*

*Starting from the analysis of the recent scientific literature, this work discusses the strengths and weaknesses of the variety of approaches adopted and provides some recommendations for LCA practitioners on how to deal with food loss in LCA applications focused on food products.*

### 2. Introduction

With about 30% of food being lost through the supply chain, food loss is a major issue both from environmental and social points of view and several initiatives at international and national level have been undertaken in order to address this issue, e.g. [1], [2]. LCA can play a major role in quantifying the environmental impact of these losses and help to identify the best lost reduction and waste valorisation possibilities. Nevertheless, the current lack of consistency in defining and quantifying food loss and waste can limit dramatically the usefulness of the LCA results.

This work aims at opening the way towards the harmonisation of the modelling and methodological approach for the assessment of the environmental burdens of FLW within LCA studies. Considering the huge amount of works on the assessment of the environmental burdens of food production, an analysis of representative articles published in scientific journals was done.

### 3. Food loss, food waste and food wastage: definition

FAO [3] pointed out that a clear definition of FLW is desirable in order to foster collaboration in the food loss reduction and has recently proposed a Definitional framework of food loss [3].

FLW is the amount of food intended for human consumption that, for different reasons, is not used for its main purpose. It takes place at each stage of the food supply chain (FSC) (modified from [3]).

The terms ‘food loss’ and ‘food waste’ have traditionally been referred to food that is left to rotten on fields or thrown away respectively during the first stages of the FSC and when food is not fit for human consumption. In the recent definition provided by the FAO [3], food loss is considered to happen during the entire FSC and food waste is the part of food loss happening at retail and consumer phases. According to [4], ‘food wastage’ is synonymous with ‘food loss’ (Figure 1).

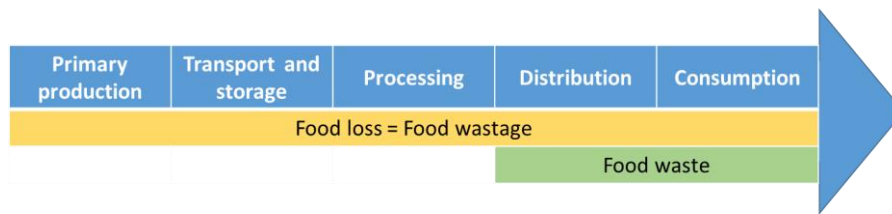

Figure 1: Correspondence between the FSC stages and the definitions of 'food loss' and 'food waste' and 'food wastage' according to FAO [3], [4] Food loss in LCA

The impact of FLW has been analysed in LCA studies from different perspectives according to their aim: (1) studies on waste management treatments, including the organic component; (2) studies on the environmental impact of food loss; (3) studies focused on a food product or dietary choices in which the amount of food loss is included. The present study is focused on the last category of works.

### 3.1 Food loss generated within the supply chain

In Table 1 a non-exhaustive summary of the food loss that can occur within the FSC is reported [4], [5]. The amount and the type of loss are influenced by the cultural and technological context. In particular the higher amount of food loss in low-income countries is generated at the first stages of the FSC due to technical, financial and managerial limitations (lack of proper storing chamber, inefficient transportation system, etc.), whereas food loss in high-income countries is mainly due to consumers' behaviour and lack of coordination among the actors of the FSC [6].

### 3.2 How is food loss accounted in LCA

FLW, particularly in the first stages of the FSC, is frequently recovered as, for example, animal feed or as a co-product for another system. Starting from the distribution stage in the FSC, instead, not consumed food is mostly sent to traditional waste management systems, such as anaerobic digestion and incineration. In the latter case, when performing an LCA, this waste should not be considered as an elementary flow, but its management and treatment should be included in the assessment until the related elementary flows cross the system boundary [7]. If the food loss is assumed to be recovered, instead, the choice of including the recovery practices depends on the system boundary and on the goal of the study. Both the valorisation of the food loss or its disposal can generate valuable products and different approaches can be applied in LCA to account for them. Table 2 reports examples of approaches to account for food loss as adopted in LCA studies published on scientific journals.

Some specific issues were observed in LCA studies when dealing with food loss. Disposal treatments, for example, can be modelled without considering the specific composition of the disposed flow. This can be a critical aspect and result in misleading conclusions, for example, when considering credits of energy from incineration [8].

	<b>Crops</b>	<b>Animals and animal products</b>
Primary production	<ul style="list-style-type: none"> <li>- Not-harvested edible products</li> <li>- Edible product harvested but not absorbed by the market</li> <li>- Rotten fruit or vegetables</li> <li>- Damaged products</li> </ul>	<ul style="list-style-type: none"> <li>- Death during breeding</li> <li>- Loss of milk due to disease or during collection</li> <li>- Discard during fishing (including discarded by-catch intended for human consumption but excluding by-catch that is not intend for human consumption)</li> </ul>
Transport and storage	<ul style="list-style-type: none"> <li>- Loss due to spillage</li> <li>- Loss due to bad handling</li> <li>- Loss due to food damages</li> <li>- Loss due to wrong storage temperature.</li> </ul>	<ul style="list-style-type: none"> <li>- Losses during transport to slaughterhouse</li> <li>- Loss due to bad storage</li> </ul>
Processing	<ul style="list-style-type: none"> <li>- Process loss of edible parts</li> <li>- Unavoidable loss (e.g. skins...)</li> <li>- Loss due to contamination</li> <li>- Loss due to inappropriate packaging that damages the product</li> </ul>	<ul style="list-style-type: none"> <li>- Edible process loss</li> <li>- Unavoidable process loss (e.g. bones, leather etc)</li> <li>- Loss due to inappropriate packaging that damage the product</li> </ul>
Distribution	<ul style="list-style-type: none"> <li>- Loss due to inappropriate cooling, storage facilities,</li> <li>- Loss due to passed expiration date</li> <li>- Unsold products</li> <li>- Rejections after quality controls</li> </ul>	
Consumption	<ul style="list-style-type: none"> <li>- Loss due to lack of storage facilities</li> <li>- Not consumed cooked food</li> <li>- Loss due to passed expiration date due, for example, to inappropriate packaging size (more food than the quantity wanted)</li> <li>- Loss due to low consumers' appreciation</li> <li>- Unavoidable loss (e.g. fruit kernels, bones etc.)</li> </ul>	

Table 1: Possible food loss per FSC stage. Modified from [4], [5]

<b>Type of loss</b>	<b>Destination</b>	<b>LCA modelling options</b>	<b>Ref</b>
Not-harvested products	Ploughed into the soil/left on the field	Emissions not accounted	[9]
Rotten products			
Processing co-products	Fertilisation	Emissions not accounted	[10]
		System expansion - nutrients content	[11]
	Animal feed	System expansion (content of energy, protein, mass)	[12],
		Allocation (economic, mass, physical)	[13], [14]
		No burden	[15]
	Cosmetic industry	Allocation (economic, mass)	[13]
Anaerobic digestion	System expansion - electric and thermic energy production from biogas	[9]	
	Allocation - economic	[9]	
Unconsumed food	Incineration	System expansion - energy content	[11]
	Composting	Composting accounted for, no credit for compost	[16]
	Landfill	Landfilling accounted for, no credit for CH <sub>4</sub> recovery	[17]

Table 2: Non-exhaustive summary of the different options applied for including losses at the primary stage in LCA studies focused on food products

#### 4. Conclusion

LCA has can help in supporting the FLW reduction challenge by quantifying pros and cons. However lack of completeness in the modelling of the food lost through the FSC and methodological choices can substantially influence the results. Adopting a shared terminology is at the core of facilitating harmonisation of approaches and information exchange.

Moreover, LCA practitioners are recommended to consider all the losses that can take place at every stage of the FSC, including the unavoidable ones, and report transparently the amount of FLW, the sources of data and how FLW is accounted in LCA defining clearly the allocation or the substitution criteria.

## 5. References

- [1] UNEP, “Think-Eat-Save,” 2013. [Online]. Available: <http://thinkeatsave.org/>.
- [2] FAO, “Global initiative on food loss and food waste reduction,” 2011. [Online]. Available: <http://www.fao.org/save-food/en/>.
- [3] FAO, “Working paper DEFINITIONAL FRAMEWORK OF FOOD LOSS,” 2014.
- [4] FAO, “Food wastage footprint. Impacts on natural resources. Summary Report,” 2013.
- [5] J. Parfitt, M. Barthel, and S. Macnaughton, “Food waste within food supply chains: quantification and potential for change to 2050.,” *Philos. Trans. R. Soc. Lond. B. Biol. Sci.*, vol. 365, no. 1554, pp. 3065–81, Sep. 2010.
- [6] FAO, “Global food losses and food waste - Extent, causes and prevention,” 2011.
- [7] European Commission - Joint Research Centre - Institute for Environment and Sustainability, *International Reference Life Cycle Data System (ILCD) Handbook - General guide for Life Cycle Assessment -- Detailed guidance*. 2010.
- [8] L. M. Gruber, C. P. Brandstetter, U. Bos, and J. P. Lindner, “LCA study of unconsumed food and the influence of consumer behavior,” in *Proceedings of the 9th International Conference on Life Cycle Assessment in the Agri-Food Sector*, 2014, no. 1.
- [9] F. De Menna, M. Vittuari, and G. Molari, “ScienceDirect Impact evaluation of integrated food-bioenergy systems : A comparative LCA of peach nectar,” *Biomass and Bioenergy*, vol. 73, pp. 48–61, 2014.
- [10] L. Coltro, A. Mourad, P. Oliveira, J. Baddini, and R. Kletecke, “Environmental Profile of Brazilian Green Coffee,” *Int. J. Life Cycle Assess.*, vol. 11, no. 1, pp. 16–21, Jan. 2006.
- [11] F. Fantozzi, P. Bartocci, B. D’Alessandro, F. Testarmata, and P. Fantozzi, “Carbon footprint of truffle sauce in central Italy by direct measurement of energy consumption of different olive harvesting techniques,” *J. Clean. Prod.*, vol. 87, pp. 188–196, 2015.
- [12] M. Cordella, A. Tugnoli, G. Spadoni, F. Santarelli, and T. Zangrado, “LCA of an Italian Lager Beer,” *Int. J. Life Cycle Assess.*, vol. 13, no. 2, pp. 133–139, 2008.
- [13] B. Nucci, M. Puccini, L. Pelagage, S. Vitolo, and C. Nicolella, “Improving the environmental performance of vegetable oil processing through LCA,” *J. Clean. Prod.*, vol. 64, pp. 310–322, 2014.
- [14] S. González-García, A. Hospido, M. T. Moreira, G. Feijoo, and L. Arroja, “Environmental life cycle assessment of a galician cheese: San Simon da Costa,” *J. Clean. Prod.*, vol. 52, pp. 253–262, 2013.
- [15] V. Prudêncio da Silva, H. M. G. van der Werf, S. R. Soares, and M. S. Corson, “Environmental impacts of French and Brazilian broiler chicken production scenarios: An LCA approach,” *J. Environ. Manage.*, vol. 133, pp. 222–231, 2014.
- [16] M. Cellura, F. Ardente, and S. Longo, “From the LCA of food products to the environmental assessment of protected crops districts: A case-study in the south of Italy,” *J. Environ. Manage.*, vol. 93, no. 1, pp. 194–208, 2012.
- [17] E. Svanes and A. K. S. Aronsson, “Carbon footprint of a Cavendish banana supply chain,” *Int. J. Life Cycle Assess.*, vol. 18, no. 8, pp. 1450–1464, Jun. 2013.

# Challenges and opportunities in using Life Cycle Assessment and Cradle to Cradle® for biodegradable bio-based polymers: a review

Monia Niero<sup>1</sup>, Renil Manaf<sup>2</sup>, Birger Lindberg Møller<sup>2</sup>, Stig Irving Olsen<sup>1</sup>

<sup>1</sup>QSA Division, Department of Management Engineering, Technical University of Denmark, Produktionstorvet 424, 2800 Kgs. Lyngby (Denmark)

<sup>2</sup>Carlsberg Laboratory, Gamle Carlsberg Vej 10, 1799 Copenhagen (Denmark)

E-mail contact: [monni@dtu.dk](mailto:monni@dtu.dk)

## 1. Abstract

*Both Life Cycle Assessment (LCA) and Cradle to Cradle® (C2C) approaches can provide operative insights in the design of biodegradable bio-based polymers. Some of the challenges shared by both LCA and C2C that need further investigation are the use of lab scale data versus primary data from established technologies and the identification of the best option for the end of use stage, e.g. for use as packaging. We consider the case of a natural fiber-based composite material obtained from barley straw and present some insights from both LCA and C2C perspectives in the identification of the best option for its end of use.*

## 2. Introduction

Biodegradability appears as a positive material attribute with regards to environmental impact [1]. However, from a Life Cycle Assessment (LCA) perspective there is no predefined answer to the question whether biodegradable bio-based polymers are better than fossil based polymers [2]. The answer changes according to the feedstock used, the market and context, since the environmental performance of biodegradable bio-polymers depends mainly on two factors: (i) the farming practices used to grow the feedstock, often carrying significant environmental burdens, and the production processes requiring more energy during manufacturing than petrochemical polymers; and (ii) the choice of the end-of-life (EoL) option [1].

Environmental impacts resulting from agricultural production need to be managed in order to maintain and improve any benefits gained by transitioning to bio-based production. Better agricultural nutrient management practices and/or the development of new feedstock that require minimal energy and nutrient inputs are two ways forward [3]. In the past, LCA of bio-based packaging focused mainly on Global Warming Potential (GWP) and fossil resource depletion, while largely ignoring other environmental impacts. However, considering only GWP and fossil resource depletion can be misleading, since some trade-offs are present if other impact categories are introduced, such as eutrophication, ozone depletion, human toxicity, land use and water consumption [3]. A peculiarity of LCA is its focus on eco-efficiency, i.e. reducing the negative impact of products per function delivered, in descriptive terms. LCA can be integrated with the eco-effectiveness concept of the Cradle to Cradle® (C2C) design framework of maximizing the benefit to humans and ecological systems. The C2C design framework has a prescriptive approach, which aims at designing products that define materials as nutrients or resources by enabling their perpetual flow within one of two distinct schemes of metabolism: the biological metabolism and the technical metabolism [4]. Bio-based, biodegradable polymers are an example of the so-called “products of consumption” that fit into the biological metabolism. Within bio-based raw materials, a strategy gaining more attention is the use of agricultural residues/by-products to produce polymers, either modified starch- or lignine/cellulose- based.



In this context, we discuss the main challenges and opportunities in the combined use of LCA and C2C in the design stage and focus on the identification of the end of use option in the case of a natural fiber-based composite material obtained from barley straw.

### 3. Main challenges and opportunities from LCA and C2C in the design phase

The main challenges and opportunities emerging when applying LCA and C2C in the design of biodegradable bio-based polymer are summarized in Table 1, considering the four steps of the LCA [5] and the three guiding C2C principles [6]. What the two approaches can learn from each other, as well as the usability of LCA in a C2C process, has already been discussed [7, 8].

LCA			C2C		
Step	Challenge	Opportunity	Principle	Challenge	Opportunity
<b>1. Goal and scope definition</b>	Allocation between co-products, as well as between different uses of the residues	Identification of the less environmental impacting option	<b>1. Waste = Food (Everything is a resource for something else)</b>	Identify the defined use of product obtained from the biobased, biodegradable material in the biological cycle through identification and optimization of all components, including e.g. additives, fillers	Assess the design for cascade use/ compostability or recyclability of the product. These polymers might be technical nutrients, depending on additives and defined use scenario
<b>2. Life Cycle Inventory</b>	- Use of lab scale data - Identification of the substitute product when system expansion is applied - Dataset availability	Take into account the benefit of recovery of material not only from a quantitative, but also qualitative point of view			
<b>3. Life Cycle Impact Assessment</b>	Avoid burden shifting	Include relevant impact categories, e.g. land use, land use change, water consumption-related categories; temporary carbon storage (e.g. [9])	<b>2. Use current solar energy income</b>	Use of renewable energy during product manufacturing	Extend the use of renewable energy to the further steps in the upstream and downstream chain
<b>4. Life Cycle Interpretation</b>	Include the learnings from LCA not only ex-post, but also ex-ante, i.e. at the early design phase	Use sensitivity analysis to test the influence of relevant assumptions	<b>3. Celebrate diversity</b>	Include biodiversity as well as cultural diversity	Identify the option capable to be beneficial to the system, and not only less negative

Table 1: Non-exhaustive list of LCA and C2C main challenges and opportunities in the design phase.

### 4. The case of natural fiber-based composite material

Meldal and Manat [10] developed a biodegradable polymer with natural fibers with low degree of swelling in water, extremely low permeability to gasses such as CO<sub>2</sub> and high strength. It is prepared from a prepolymerization mixture of grafted plant derived material and monomers and/or cross-linkers [10], for possible application as substitutes for fossil based polymers.

#### 4.1 Production process

The production process of the biodegradable bio-polymer is represented in Figure 1, which includes the main production steps as well as the input and output. The main input material is barley straw, a residue from barley cultivation, which undergoes a series of chemical transformations to produce a biodegradable polymer with around 65-85% of bio-based material. The main steps of production rely on the lab scale process, and the input and output listed refer to lab scale data, which do not reflect the production at the industrial level,

e.g. in terms of energy consumption or yields. Some guidance on how to deal with system boundary definition, scaling issues, and uncertainty in LCA of emerging technologies is available, e.g. [11].

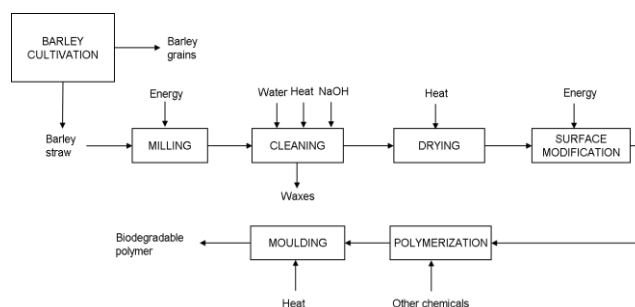

Figure 1: Representation of main production steps of the natural fiber-based composite material

#### 4.2 End-of-use

One of the main challenges during the development process of the above mentioned natural fiber-based material was the identification of the best end of use option. LCA and C2C can provide some insights in this regard, even though there are large uncertainties related to the waste management stage of biodegradable materials in LCA studies. One reason is the lack of data on the extent of biodegradation of biopolymers in the different environments, which is important to determine their suitability for that disposal route and the emissions generated and energy recovered (for methane captured from landfill and anaerobic digestion) [1]. From a C2C point of view, challenges for biodegradable polymers in packaging applications are to determine the suitability of the whole product including additives and fillers for the biosphere and to identify the cascade of uses ultimately leading to the return of nutrients into the biosphere, e.g. through composting or anaerobic digestion. Specific infrastructures in terms of establishment of appropriate collection, transportation, and treatment technologies are considered crucial to the success of widespread applications of biodegradable packaging materials [12], together with the capability to secure its correct disposal. From LCA perspective, the application of the EU waste hierarchy should be discussed case by case, since composting (considered as a form of recycling and therefore high level in the waste hierarchy) performed worse in terms of environmental impacts compared to incineration with energy recovery (lower level in the waste hierarchy) for biodegradable materials used for dry packaging [13].

### 5. Conclusion

We qualitatively illustrated which insights LCA and C2C can provide in the design of biodegradable bio-based polymers, with regard to each step of LCA, as well as the key principles of C2C. Both approaches share some challenges that need to be further investigated, e.g. arising from the use of lab scale data versus primary data from established technologies and the identification of the best option for the end of use stage. In particular, we addressed the last point in the case of a natural fiber-based composite material obtained from barley straw, which is dependent on the definition of the cascade of uses of the material in multiple cycles.

### 6. Acknowledgements

The authors would like to thank Carlsberg Foundation for funding the project “Design of Cradle to Cradle® - Inspired System for Beer Packaging” and Katja Hansen from EPEA for her feedback.

## 7. References

- [1] Yates, M.R, Barlow, C.Y., 'Life cycle assessments of biodegradable, commercial biopolymers—A critical review' *Resources, Conservation and Recycling* 78 (2013) 54-66.
- [2] Miller, S.A., Landis, A.E., Theis, T.L., 'Feature: environmental trade-offs of biobased production.' *Environmental Science & Technology* 41 (2007) 5176-5182.
- [3] Hottle, T.A, Bilec, M.M, Landis, A.E., 'Sustainability assessments of bio-based polymers', *Polymer Degradation and Stability* 98 (2013) 1898-1907.
- [4] Braungart, M., McDonough, W., Bollinger, A., 'Cradle-to-cradle design: creating healthy emissions - a strategy for eco-effective product and system design', *Journal of Cleaner Production* 15 (2007) 1337-1348.
- [5] ISO Environmental management. Life cycle assessment. Principle and framework. ISO 14040:2006.; Geneva, Switzerland, 2006.
- [6] McDonough, W.; Braungart, M. 'Cradle to cradle' (North Point Press. New York, 2002).
- [7] Bjørn, A.; Hauschild, M. Z. Absolute versus Relative Environmental Sustainability. *Journal of Industrial Ecology* 17 (2013) 321–332.
- [8] Bor, A.-M.; Hansen, K.; Alan Riviere, A.; Alvarado, C.; van den Wittenboer, W. Usability of Life Cycle assessment for Cradle to Cradle purposes ( NL Agency, Utrecht, 2011)
- [9] Brandão, M., Levasseur A., Kirschbaum, M.U.F., Weidema, B.P., Cowie, A.L., Jørgensen, S.V., Hauschild, M.Z., Pennington, D., Chomkamsri, K. 'Key issues and options in accounting for carbon sequestration and temporary storage in life cycle assessment and carbon footprint', *International Journal of Life Cycle Assessment* 18 (2013) 230-240.
- [10] Meldal, M., Manat, R. 'Cellulose based polymer material' Patent N.US 8,796,362 B2. 5 August 2014.
- [11] Hetherington, A.C., Borrion, A.L., Griffiths, O.G., McManus, M.C., 'Use of LCA as a development tool within early research: challenges and issues across different sectors' *International Journal of Life Cycle Assessment* 19 (2014) 130–143.
- [12] Davis, G, Song, J., 'Biodegradable packaging based on raw materials from crops and their impact on waste management' *Industrial Crops and Products* 23(2) (2006) 147–161.
- [13] Rossi, V., Cleeve-Edwards N., Lundquist, L., Schenker, U., Dubois, C., Humbert, S., Jolliet, O. 'Life cycle assessment of end-of-life options for two biodegradable packaging materials: sound application of the European waste hierarchy' *Journal of Cleaner Production* 86 (2015) 132-145.

# **The Hamlet dilemma for aluminium cans in the circular economy: to be or not to be in a closed loop?**

*Monia, Niero<sup>1</sup> Simon, H. Boas<sup>2</sup> Håkon, Langen<sup>2</sup> Stig, I. Olsen<sup>1</sup>*

*<sup>1</sup>QSA Division, Department of Management Engineering, Technical University of Denmark,  
Produktionstorvet 424, 2800 Kgs. Lyngby (Denmark)*

*<sup>2</sup>Carlsberg Breweries A/S, Ny Carlsberg Vej 100, 1799 Copenhagen (Denmark) Carlsberg*

*E-mail contact: [monni@dtu.dk](mailto:monni@dtu.dk)*

## **1. Abstract**

*In the context of circular economy the focus is not only on recycling from a quantitative point of view, but also on improving the quality of materials. We considered the case of aluminium cans, and quantified the influence of alloying elements on the overall environmental performances of aluminium can recycling. We performed a Life Cycle Assessment (LCA) comparing different sources of aluminium: primary aluminium and mixed scraps, Used Beverage Can (UBC) scrap, mixed aluminium packaging scrap and building scrap. The preliminary LCA results show that the lowest environmental impacts come from the use of UBC scraps. This suggests that in a circular economy context for aluminium cans it is better to be in a closed loop.*

## **2. Introduction**

It is hard to predict how the beer packaging of the future will look like, but what can be easily guessed are the challenges that the beverage packaging sector will have to face; and resource scarcity deserves a central role. Nowadays most industrial sectors are still organized according to a linear economy, where resources are extracted, transformed to manufacture goods that are used by consumers and finally disposed. An alternative is provided by the circular economy, i.e. “an industrial system that is restorative or regenerative by intention and design” [1].

In the context of circular economy, the Cradle to Cradle® (C2C) vision is gaining more and more visibility. C2C is a design framework oriented towards product quality and innovation, which aims to increase the positive (environmental) footprint of products by designing “eco-effective” solutions, i.e. maximizing the benefit to ecological systems [2]. The C2C design framework inspired the creation of the Carlsberg Circular Community, a cooperation platform launched in January 2014 featuring Carlsberg Group, the fourth largest global brewer in the world, and a selection of global partners with the ultimate aim to eliminate the concept of waste by rethinking the design of packaging, including the aluminium can [3].

According to the European Aluminium Association [4], from an environmental point of view it doesn't matter whether used cans end up again in new cans or in other product systems. When Life Cycle Assessment (LCA), based on the eco-efficiency approach, is applied to an aluminium can, the aim is to identify which solutions can decrease the environmental impacts of the product, see e.g. [5]. In its current status the Life Cycle Inventory (LCI) of aluminium processes is based on a pure aluminium flow, neglecting the presence of alloying elements [6]. However, within the circular economy context, the C2C vision calls for improving the quality and value of materials, through a characterization of chemicals included in the products, the so-called ABC-X assessment, and the development of an optimization strategy [7]. When scrap

quality is taken into account in the LCA of aluminium recycling, it turned out that packaging scrap can be managed in a separate closed loop recycling strategy for the same application [8].

In the present study, we focused on a specific type of aluminium packaging, i.e. beverage cans, which are made of two parts: the can body (typically A3004 alloy) and the lid (typically 5182 alloy). We considered the influence of alloying elements and old scrap composition on the overall environmental performances of aluminium can recycling with the aim to identify the best option from an environmental point of view.

### 3. Methodology

We considered the case of a 33 cl Carlsberg can produced in the UK market (see Figure 1) and followed the approach proposed by Løvik and Müller [9] for quantifying the accumulation of the main alloying elements (Mn, Fe, Si, Cu) according to different sources of aluminium: (a) primary aluminium and mixed scraps, (b) Used Beverage Can (UBC) scrap, (c) mixed aluminium packaging scrap and (d) building scrap [10].

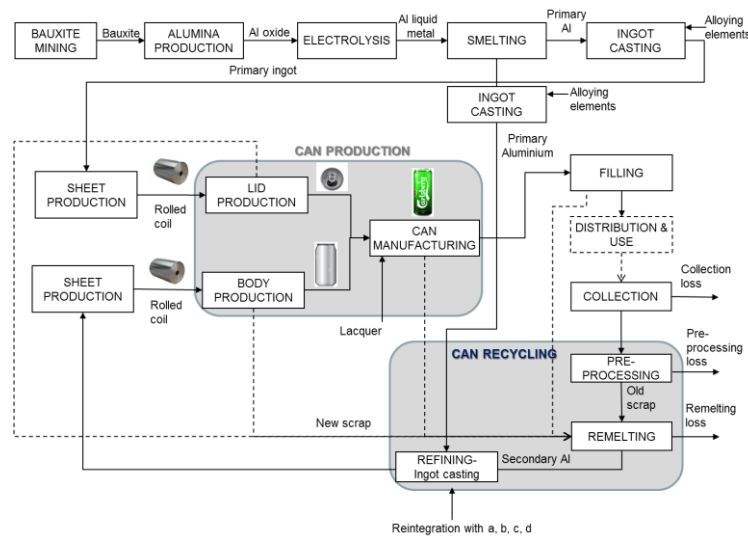

Figure 1: Life cycle stages of an aluminium can; dashed lines represents excluded phases/flows

#### 3.1 Main assumptions

We used mainly primary data to model the life cycle of the aluminium can [11]. The recycling rate was considered equal to 57% [12], and 67,8% as average recycled content of the can [13]. We calculated the collection rate based on scrap-specific pre-processing ([8] for current system and case (d); [13] for cases (a),(b)), and remelting yields [14]. We assumed that a recycling loop takes 60 days [8] and calculated for each scenario the amount of alloying elements that should be added in every loop to comply with can body composition requirements. The end-of-life of the can was modeled according to the Product Environmental Footprint formula [15], being the most suitable method for considering multiple uses of resources in continuous loops.

### 4. Results

#### 4.1 Accumulation of Mn in can body

Mn emerged as the limiting alloying element for can body recycling. Figure 2 includes the variation of Mn concentration in can body for the different scenarios, with and without composition adjustment to comply with Mn thresholds (1-1,5%) for the can body alloy A3004.

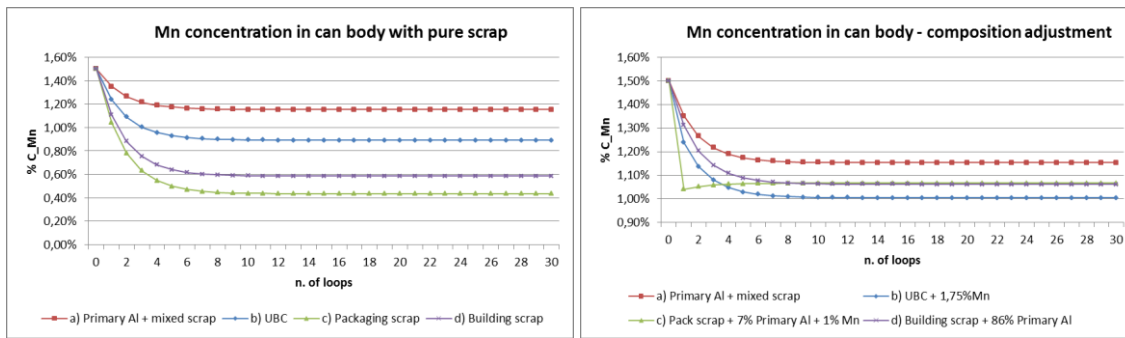

Figure 2: Mn concentration (%) in new body can according to different sources.

## 4.2 LCIA results

The preliminary LCIA results obtained with ILCD recommended method [16] (see Figure 3 including a selection of relevant impact categories), shows that the lowest environmental impacts refer to the case of closed loop, i.e. case b considering UBC scrap.

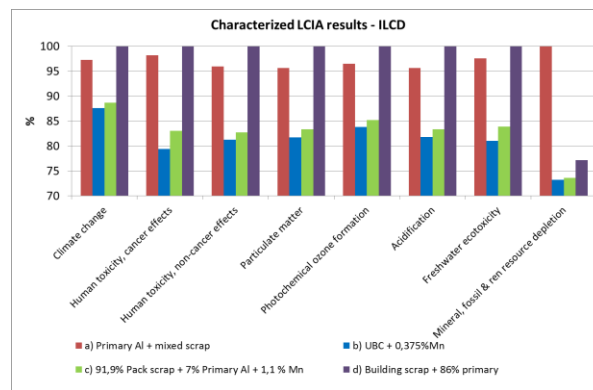

Figure 3: Preliminary LCIA results of a new body can referring to loop  $n = 1$

## 5. Conclusion

The C2C design framework can inspire LCA in considering the multiple future uses of resources in continuous loops for aluminium cans, but the actual alloy composition and accumulation of alloying elements under multiple recycling loops should be considered. The preliminary LCA results of the production of can body after one recycling loop show that the environmental benefits are greater for UBC scraps, therefore suggesting that for aluminium can it is better to be in a closed product loop. The implications with a higher number of recycling loops and collection rate should be further investigated, as well as the effect of uncertainty analysis on the robustness of the comparative LCA.

## 6. Acknowledgements

The authors would like to thank Carlsberg Foundation for funding the project “Design of Cradle to Cradle® - Inspired System for Beer Packaging”.

## 7. References

- [1] EMF, 'Towards the circular economy. Opportunities for the consumer goods sector'; 2013; pp. 1–112. Ellen MacArthur Foundation.
- [2] McDonough, W., Braungart, M., 'Cradle to cradle—Remaking the way we make things', (North Point Press, New York, NY, USA, 2002)
- [3] Carlsberg Group, Carlsberg Group CSR Report 2014; 2015; pp. 1–57.

- [4] Labberton MG. Aluminium Packaging: convenient, safe and infinitely recyclable. Aluminium Fair, Düsseldorf 2014 [http://www.european-aluminium.eu/wp-content/uploads/2011/08/04\\_Packaging\\_The-impact-of-the-revision-of-the-EU-waste-law-on-packaging.pdf](http://www.european-aluminium.eu/wp-content/uploads/2011/08/04_Packaging_The-impact-of-the-revision-of-the-EU-waste-law-on-packaging.pdf)
- [5] Stichling, J.; Nguyen-Ngoc, D. 'Life Cycle Inventory and Impact Analysis for Beverage Cans.' Final Report; 2009; pp. 1–100. PE International.
- [6] EAA, 'Environmental Profile Report for the European Aluminium Industry. Life Cycle Inventory data for aluminium production and transformation processes in Europe', Eu Alumin. Assoc. (2013)
- [7] Cradle to Cradle Products Innovation Institute. Cradle to Cradle Certified CM. 'Product standard Version 3.0' (2013) [http://www.c2ccertified.org/product\\_certification/c2ccertified\\_product\\_standard](http://www.c2ccertified.org/product_certification/c2ccertified_product_standard)
- [8] Paraskevas, D., Kellens, K., Dewulf, W., Duflou, J.R., 'Environmental modelling of aluminium recycling: a Life Cycle Assessment tool for sustainable metal management', J Clean Prod doi:10.1016/j.jclepro.2014.09.102
- [9] Løvik, A., Müller, D.B., 'A Material Flow Model for Impurity Accumulation in Beverage Can Recycling Systems' Light Met. (2014) 907–11
- [10] Hatayama, H., Daigo, I., Matsuno, Y., Adachi, Y., 'Evolution of aluminum recycling initiated by the introduction of next-generation vehicles and scrap sorting technology.' Resour Conserv Recycl 66 (2012), 8–14.
- [11] Niero, M., Negrelli, A.J., Boas, S.H., Olsen S.I., Birkved M., 'Closing the loop for aluminium cans', April 2015. Submitted to Metallurgical, Research and Technology.
- [12] Alupro. The aluminium packaging organization. retrieved at <http://www.alupro.org.uk/aluminium-packaging-the-beverage-can/>
- [13] PE Americas 'Life Cycle Impact Assessment of Aluminum Beverage Cans' Final report. PE Americas (Boston, USA, 2010)
- [14] Leroy C., 'Provision of LCI data in the European aluminium industry Methods and examples' Int J Life Cycle Assess (2009) 14 (Suppl 1):S10–S44
- [15] EC, ANNEX II: Product Environmental Footprint (PEF) GUIDE to the COMMISSION RECOMMENDATION on the use of common methods to measure and communicate the life cycle environmental performance of products and organisations. European Commission; Brussels.
- [16] Hauschild, M.Z., Goedkoop, M., Guinée, J., Heijungs, R., Huijbregts, M., Jolliet, O., Margni, M., De Schryver, A., Humbert, S., Laurent, A., Sala, S., Pant, R., 'Identifying best existing practice for characterization modeling in life cycle impact assessment' Int J Life Cycle Assess 18 (2013) 683–697.



# Sustainability assessment of food supply chains: socio-economics drivers and impacts





## **In food supply chain: social LCA, what to do?**

*Macombe, Catherine<sup>1</sup> & Loeillet, Denis<sup>2</sup>*

<sup>1</sup> *IRSTEA, UMR ITAP, 1 rue Pierre-Gilles de Gennes CS10030, 92761 Antony cedex France*

<sup>2</sup> *CIRAD, UR GECO F-34398 Montpellier, France*

*E-mail contact: catherine.macombe@irstea.fr*

### **1. Abstract**

*This paper deals with four different social demands for the so-called methods “social LCA”. As they call for different social LCA methods, it is worth making a short review of the needs range.*

### **2. Introduction**

In this keynote, I will start from the so-called method « social LCA », because it is the only one domain where I have little knowledge. Nevertheless, some ideas might be deemed interesting for colleagues working in sustainable LCA or LCC. About the implementation domains, I will talk about agro-food value-chains (filiera). Different methods are gathered under the same name of “social LCA”. For researchers, scientific soundness seems mandatory, whatever the social purpose. But this exigence is not shared by all the actors.

When screening practices on the ground –regarding agro-food life cycle assessment- one can’t help to be surprised by the abundance of « tools ». This means that something important is at stake, which meets social demand. To what kinds of social needs do these tools answer?

If we globally think about the « social functions » of these tools, it seems that these functions match four families of needs : “ to reassure oneself”, “to know in order to decide”, “to adjust action”, “to ensure power on market”. We claim that all the needs are legitimate and must be taken into account. As they call for different social LCA methods, It is worth making a short review of the needs range.

### **3. Needs to reassure oneself**

According us, here is the most usual usage of social LCA. For instance, it is the supposed needs of consumers to get more and more detailed information about the food before buying it. When asked for their opinion, it seems that they need to be reassured by effective controls. It also explains the behavior of some companies (especially food retailers) which deem that the label got by the supplier is a warranty for quality, and protects their own responsibility. Of course, this is not cautious because the signs offer few warranties in fact. Indeed, most signs (with the noticeable exception of organic agriculture) are proposed, developed, validated and certified by the same people. These practitioners build an “epistemic community” where people circulate during their vocational life span, skipping from appraiser to certifying officer, to label’s manager or “external” auditor. They share the belief that they do well, and they co-opt and self-perpetuate the system, whose weaknesses they hide. Any drift, any accident might occur in such conditions!

Other kinds of organizations often feel the necessity to reassure by “guarding against”. International funders, supra national organizations are inclined to show that they make their best regarding the process, without really caring about the output.

They quote multiple “guidelines” which are political constructions, as if they were providing warranties for efficiency or relevance. They prefer covering themselves (they think they do so!) against the reproach to have forgotten or neglected one criterion, than learning something new about the social impacts of their decisions. Of course, they cannot succeed in the long run, because anything new (scandal, accident) can occur.

#### **4. Needs to know for decision-making**

When it comes to the literature about life cycle assessment, authors present the approach as providing “tools for decision-making”, meaning that outputs of LCA study should help choosing in favor or such or another solution. Under the cover of “decision” is hidden a specific conceptual model. It is either the so-called “rational model”, or the “bound rationality” model by Herbert Simon. Both models share the opinion that : i) there is a pool of n existing solutions, ii) the decision-maker checks the different drawbacks and advantages of each solution, before iii) choosing the best (rational model) or the first to be appropriate (Simon’s model). We actually think that decision makers screen these solutions regarding technical feasibility, logistic, and economic. The result is that several are eliminated. But then, we can’t assert that environmental LCA is the central tool involved in decision making. It is both true and false, it depends on the scale.

About an item like one glass, it is easy to generate numerous scenarios with a lot of nuances, so the range of solutions could be designed like a continuum. In this case ELCA plays its full role of decision-making tool.

At the contrary, when the scale of the system is something like a crop system or sanitation system, the tool for helping decision combines several models, ELCA being only one small part. Regards about spatial and temporal designs become heavily binding forces. Any difference in feasibility designs a totally new scenario. In other words, the pool of solutions takes the shape of a discontinuous function, or a piecewise continuous function. Thus, the important tool is the one to design the crop system. Regarding social life cycle assessment, at the minimum, the scale we address is workshop / farm / plantation / plant. Thus, we always confront the same universe of discontinuous solutions, as in the former case of the crop system. Moreover, choosing one system or another among a pre-set range of scenarios, by following the results of one social LCA study, would be unwise. Whatever the future progress of science, we always will be unable to anticipate all the real social effects stemming from one change. Because of its congenital (and likely definitive) incompleteness, the social LCA is not a tool for decision making. It is a tool to adjust action.

#### **5. Needs to know, in order to adjust action**

In this group, we account for the decisions whose purpose is improving a system regarding environmental or social effects, reverse engineer included. In this case, the scientific position about the model of decision is the Karl Weick’s model, where decision is progressive and adjusted to the former actions.

We are quite powerless in front of soil erosion, or loss of social solidarity, including the cases where these impacts are the most important. In the absence of assessment method, we are more or less committed to neglect these impacts. Thus, as highlighted by Heiskanen (2002) or Hellweg and Mila i Canal (2014) the available impact pathways taken together build a new general normative representation of “what the impacts to be taken into account when deciding are”.

Thanks to LCA studies, decision-makers become aware of new problems and new drivers. Indeed, the impact pathway highlights the causes, and so the possible drivers and solutions.

Maybe, when we imagine that life cycle assessment is a tool for accompanying decision making, we are still too naïve. Visiting some arena has persuaded us that LCA is often a good mean to eliminate opponents.

## **6. Need to ensure power on market**

Thanks to LCAs, practitioners have elaborated certifications, standards and labels, in arenas such as AFNOR etc. Everyone will tell you that the purpose of the group is providing a tool to improve the protection of ecosystems etc. Here is the official version. Nevertheless, the shared things not said make the real group together. Certifications, standards and labels are a good mean to eliminate potential competitors. For European industrialists, the other is the Chinese industrialist. For French farmers, the other is the Southern farmer. By enforcing new norms, one builds non-tariff trade barriers.

They are power instruments not only among the opponents of the same arena, but also among the same value-chain partners. The holder of the norm therefore culturally colonizes the other steps of the value-chain, because who would dare to contest the soundness of the displayed humanistic goals?

## **7. Conclusion**

Researchers can't be blind regarding these ideas. Indeed, the categories of needs influence the choice of methods.

The last category « **Needs to ensure power on market** » deserves simple and direct methods, which quickly provide criteria to eliminate competitors which would be non-compliant with the new standard. It doesn't matter if the assessment is meaningless in social terms, or if it forgets essential elements. For instance, this kind of method delivers obvious characteristics of the social conditions around the product/service (e.g. presence or absence of child work).

The first category « **Needs to reassure oneself** » deserves tools whose reputation is to be consensual. Here we find “guidelines” and “general principles”, always revolving around the same concepts, with little expectation to be operable in practice on the ground. It doesn't matter if they evenly provide a mixed picture of the value-chain whose no one knows if it is good or not. For instance, this kind of method might call for implementing guidelines about “land-grabbing” or “human rights”.

To answer **needs in term of decision-making**, and above all in terms of **adjusting action**, requirements deal with modesty and scientific soundness. Decision-makers need time to care about each result delivered by each impact pathway, and to understand relationships and causes. They need time to adjust scenarios, and to get off the beaten tracks, in order to suggest new solutions. For instance, this kind of methods delivers cause-effect relationships starting for changes in income inequality because of the value chain changes.

At short term, methods to adjust action are less attractive than the others, because they highlight their own limits. But they modestly design drivers and new solutions. We guess that it is precisely by suggesting dramatically new solutions that LCAs methods will gain their reputation for soundness, over time.

Thank you for the comments of the colleagues attending the conference, who have helped to improve this paper. Thank you to all the partners of the Chair ELSA-PACT.

# Food redistribution in the Helsinki Metropolitan and Turku Areas

Author: Kirsi Silvennoinen & Juha-Matti Katajajuuri

Natural Resource Institute Finland, Latokartanonkaari 9, 00790 Helsinki

E-mail contact: kirsi.silvennoinen@luke.fi

## 1. Abstract

*Food redistribution was studied in two areas in southern Finland by conducting surveys, questionnaires and interviews for charity organizations redistributing food and nine companies donating food. The aim of the study was to gain an estimate of volumes, types and numbers of food bags or cooked meals made from donated food, and how the organizations and donating companies operated. The number of cooked food meal portions varied up to 10,000 portions per year, while the number of redistributed food bags was on most occasions more than 10,000, and up to 270,000 bags per year by one organization. We estimated the weight of the food bags and their economic value, and also the type of the food that is donated. The study indicates that there can be a great potential for increasing the amount of food being redistributed in Finland, and we discuss new strategies for reducing food waste and summarize the initiatives already going on in Finland.*

## 2. Introduction

In Finland, the retail, hospitality and food industry sectors produce 40–56 kilograms of avoidable food waste per year per capita, corresponding to 215–300 million kilograms of food waste per year (Katajajuuri et al. 2014). The organizations redistributing food include several parishes, organizations of unemployed people, and non-governmental organizations. The common way to conduct food redistribution is to give people food bags to take and eat at home; organizations can also offer coffee, breakfast or lunch in the canteen. Food bags will be redistributed mostly 2–3 times per week and in addition for special events e.g. Christmas and New Year's Eve, when organizations can arrange food distribution or offer meals. Finland's 226 municipalities have at least some kind of food-sharing activity once per week. The number of regular visits to food aid was around 1.2 million, and the number of all food-sharing contacts was around 1.7 million in 2013 (Ohisalo et al. 2014). The aim of this study was to gain an estimate of volumes, types and number of food bags or cooked meals made from donated food, and how the redistributing organizations and donating companies operate. So as to base our study on specialist interviews, we decided to focus on two regions that seemed to have a lot of food-sharing activity and many actors. These two areas were the Helsinki metropolitan (1.1 million inhabitants) area and the Turku area (300 000 inhabitants), both located in Southern Finland and with relatively dense populations. This study was part of the Nordic Council project (2013-2014) and was carried out simultaneously in Nordic countries (Hanssen et al 2015). Here, we only present results from Finland and consider different aspects, also numbers and volumes that have been updated for 2015.

## 3. Material and methods

We sent out questionnaires and interviewed four national level organizations and 14 local organizations. We asked for information about types and amounts of food, their views on the challenges and barriers, and from

where they acquired their food donations. We made a rough estimate of food bag amounts and weights in both study areas based on information gained from the organizations, interviews and conversations. These results have been updated for 2015 when it has been possible. Some information we also gained from published news articles and internet sites. Organizations did not always know exact numbers of visitors or volumes of food bags. If we were given the number of visitors and volume of the bag, we could estimate the total volume of the food redistributed. We went on a one-day excursion to one sharing point to see in practice how food is handled and distributed. To obtain information also from companies donating food, we sent questionnaires to donors located in the same areas as local charity organizations. We asked how often and how much, what kind of food, and why they donated food products in 2013. We asked also what kind of barriers, possible regulations and responses they have had when donating food. We assessed the climate impacts of food redistributed by average food type categories in retail sector using numerous data sources (e.g. Katajajuuri 2009, Usva et al., 2009).

#### 4. Results

The main form for redistributing food is to give a food bag to needy people; they wait their turn in line (the bread line) to receive the bag or select food items themselves from tables. All organizations redistributed food bags, and some of them also served cooked food portions or provided sandwiches. All but one answered that food they received from donors is very important, and also all but one said they received more than 50% of food redistributed as donations, rest of food are bought or received from EU Food Aid Programme. Amounts of cooked meals vary from 500 up to more than 10,000 portions per year; the number of food bags was almost always more than 10,000, and up to 270,000 bags in one organization. The volume of one food bag can vary, but is typically about 3–4 kilos (but can be up to 8–10 kg) and its value is typically 20–30 € depending on the products available. Furthermore, corresponding climate impact savings/compensation is around 10 kilograms of CO<sub>2</sub>-equivalent, as average, depending strongly on the products available. Altogether, redistribution in the Helsinki and Turku areas was about 3 million kg/year, and about 800,000 visits were made (Table 1). Producing this overall food redistribution is equivalent to an environmental benefit of almost 10 million kilos of CO<sub>2</sub>-eq-emissions. The retail sector donated fresh bread, fruit, vegetables and milk products, but also meat and cheese. Amounts vary daily but bread and vegetables were common food donated. The food industry donated their products not going to the sales process and they did not donate as often, mostly 2–3 times per week and about 10,000 kg/year. The main reasons not to donate all unsold food were the receiving organizations' willingness not to receive more, and also laws and food safety instructions that can prevent increasing donations. For example, food can be donated after the *best before* date has expired but it is not possible to donate when the *used by* date has expired. Not all food is suitable for donation e.g. having possible safety risks, being damaged or spoiled, and organizations cannot take all products e.g. bread. In the retail sector, a 30% discount for product going to reach each day its *use by* or *best before* date has reduced food waste a great deal in recent few years. If food is near to its *use by* or *best before* date, some retailers will donate it before the date expires as they see that products are not going to be sold before date expires. An estimation based on interviews is that about half of the Helsinki and Turku areas retail outlets donate food to charity organizations. The food that has reached its expiry date and is not donated

will be delivered to compost or another organic waste plant. Even only very small amounts of food waste will end up into the mixed waste and landfill, it is always better according to waste hierarchy, to redistribute food for human consumption than e.g. for energy use.

## 5. Discussion and conclusion

The volume of donated food redistributed by organizations was 3 million kg/year, and this can be cautiously compared to food wasted from the retail sector in the same areas of about 20 million kg/year. It must be remembered that a large part of the donated food comes also from the food industry and wasted amounts in that sector in the areas studied are not known an adequate level to estimate. Even amounts are not estimated here, it is a large potential for increased redistribution from retail and industry corresponding to 140–215 million kilograms of food waste per year in Finland (Katajajuuri et al. 2014). From the hospitality sector 75–85 millions kg/year is wasted e.g. schools. School canteens and other public services could donate more than they do today; a large number have even started to organize lunch made from surplus food. Public food services are important as they provide up to half of the meals consumed outside the home (YM 2014). Also, consumers would like to see restaurants and retail stores donating their surplus and *use by* and *best before* date food to charities for redistribution (Silvennoinen et al. 2013). The study showed that safety instructions can increase food waste when the *use by* date has expired. In Finland, the food industry can decide whether they use *best before* or *use by* dates in their products. The food industry could consider more products with *best before* dates when it possible without risking food safety. The Finnish food safety authority Evira has launched new guidance for food aid (Evira 2013), and that has made donations more compelling for donors and provided new possibilities for activities and initiatives. The purpose of the guidance is to clarify food donation procedures and liability concerns and also provide guidance in a manner that the amount of food waste can be reduced. The respondents have shown a consensus that, with this guidance, responsibilities are clearer and that has increased the amounts of donations.

Organization	Serving meals	Meals/week	Number of visitors	Estimate of food redistributed (bags) kg/year	Donators by sectors
1	no	x	15,000	52,500	RE, IND
2	no	x	200,000	700,000	IND, RE
3	yes	1–2	20,000	70,000	RE
4	no	x	114,000	399,000	IND, RE
5	no	x	10,000	35,000	RE, IND, HOSP, OT, CANT
6	no	x	270,000	945,000	IND, RE, WHOLES
7	yes	1–2	7,500	26,250	IND
8	yes	1–2	4,000	10,500	IND, RE, WHOLES, CANT
9	yes	1–2	20,000	70,000	RE, IND
10	no	x	19,500	68,000	IND, RE, FA
11	yes	1–2	7,500	26,250	CANT, RE
12	yes	3–5	58,375	467,000	IND, RE, FA, WHOLES
13	yes	1–2	10,000	35,000	RE
14	yes	1–2	24,000	84,000	RE, CANT, IND, FA
Total kg			779,875	2,988,500	

Table 1: Organizations redistributing food, number of meals/week and visitors/year, volume kg of the bags and donating sectors in order of importance RE= retail, IND= food industry, HOSP=hospitality sector, CANT=canteens, WHOLES=wholesale, FA=primary production, farms, OT=others

## 6. References

- Evira 2013. Foodstuffs donated to food aid 21.5.2013. Instructions 16035/1. Available: [http://www.evira.fi/files/attachments/en/food/manufacture\\_and\\_sales/ruoka-apuohje\\_16035\\_2013\\_en\\_final.pdf](http://www.evira.fi/files/attachments/en/food/manufacture_and_sales/ruoka-apuohje_16035_2013_en_final.pdf)
- Hanssen, O., Ekegren, P., Gram-Hanssen, I., Korpela, P., Langevad-Clifforth, N., Skov-Olsen, K., Silvennoinen, K., Stare, M., Stenmarck, Å. and Svanes, E. 2015. Food Redistribution in the Nordic Region 2015: Experiences and results from a pilot study.
- Katajajuuri, J.-M., Silvennoinen, K., Hartikainen, H., Heikkilä, L. and Reinikainen, A. 2014. Food waste in the Finnish food chain. In: Towards eco-efficient agriculture and food systems: selected papers from the Life Cycle Assessment (LCA) Food Conference, 2012, in Saint Malo, France. *Journal of Cleaner Production* 73: 322–329.
- Katajajuuri, J.-M. 2009. Government Foresight Report on Long-term Climate and Energy Policy: Towards a Low-carbon Finland.
- Ohisalo, M., Eskelinen, N., Laine, J., Kainulainen, S. & Saari, J. 2014. Avun tilkkutäkki. A report on the organization of Finnish food aid. Published by Finland's Slot Machine Association.
- Silvennoinen, K., Pinolehto, M., Korhonen, O., Riipi, I., Katajajuuri, J.-M. 2013. Reduction of consumer food waste as a part of food chain responsibility (abstract in English): Kuru 2011–2013 -hankkeen loppuraportti. MTT Report 104: 58 p.
- Usva, K., Saarinen, M., Katajajuuri, J.-M. & Kurppa, S. 2009. "Supply chain integrated LCA approach to assess environmental impacts of food production in Finland" *Agricultural and Food Science* No 18, 3-4: 460-476.
- YM 2014 Ministry of the Environment. Julkiset ammattikeittiöt haastettiin kestävän kehityksen sitoumukseen. Available: [http://www.ym.fi/fiFI/Ymparisto/Kestava\\_kehitys/Ajankohtaista/Julkiset\\_ammattikeittiot\\_haastettiin\\_kes\(28703\)](http://www.ym.fi/fiFI/Ymparisto/Kestava_kehitys/Ajankohtaista/Julkiset_ammattikeittiot_haastettiin_kes(28703))



# **Integrating LCA within MuSIASEM approach to evaluate feasibility, viability and desirability of second generation bioethanol from *Arundo donax* feedstock for transportation energy needs of Campania (Italy)**

*Angelo Fierro<sup>1§</sup>, Annachiara Forte<sup>1</sup>, Amalia Zucaro<sup>1</sup>, Silvio Viglia<sup>1</sup>,  
Michele Staiano<sup>2</sup> and Mario Giampietro<sup>3</sup>*

*1Dipartimento di Biologia, Università Federico II di Napoli;  
Campus MS Angelo ed. 7, 80126 Napoli*

*§ Laboratorio di Urbanistica e di Pianificazione del Territorio (LUPT), Università Federico II di Napoli;  
via Toledo, 402, 80138 Napoli*

*2Dipartimento di Ingegneria Industriale, Università Federico II di Napoli; Piazzale Tecchio, 80, 80125 Napoli*

*3Institute of Environmental Science and Technology (ICTA), Universitat Autònoma de Barcelona (UAB);  
Carrer de les columnes E- 08193 Bellaterra - Barcelona*

*e-mail contact: [angelo.fierro@unina.it](mailto:angelo.fierro@unina.it)*

## **1. Abstract**

*The pertinence of setting a bio-energy production system needs an holistic and integrated study since its assessment has to cope with a complex system, characterized by non-equivalent views, reflecting the combined effects of several factors such as the bio-physical capacity of the territory, the societal energy demand and structure, the environmental performance of the production chain, the expected social and monetary benefits. We present here an embryonic study framework by integrating a standardized LCA into the MuSIASEM approach applied to the production system of second generation's bio-ethanol for road transportation from giant reed feedstock cultivated and used in the administrative scale of Campania Region. This approach evaluate three levels of performance (feasibility, viability and desirability) and LCA was integrated as the source of the environmental impact matrix in the feasibility perspective.*

## **2. Introduction**

Bioethanol is not just a “package of energy” to be compared with an other “package of energy” with similar function. Bioethanol is a product made by a complex and dynamic system interconnected with ecological and socio-economic systems (the bio-physical capacity of the territory, the societal energy demand and structure, the environmental performance of the production chain, the expected social and monetary benefits). As reported by the rather recent review on LCA of second generation bioethanol [1], the typical study approach is the evaluation of impacts with reference to the conventional fossil oil system. Such comparison appears little relevant since the real matter is to evaluate at what degree bioethanol is suitable to replace the energy requirement for road transportation as established by fossil fuel availability, thanks to its high power density and current low economic costs. Other important questions are generated by some scientific, policy related, economic and social narratives, which induce to identify the bioethanol as a promising source of energy enabling to reduce the environmental impact compared to fossil fuels (mainly climate change), and a driving economic factor for marginal areas. Comprehensive and relevant answers to these questions need a complex and integrated study. Therefore, such an assessment for bio-energy sector could be deployed accordingly to the MuSIASEM (Multi-Scale Integrated Analysis of Societal and

Ecosystem Metabolism) approach. The purpose is to obtain by simulation a watchful picture, addressed into the relevant perspective, since it may largely change land use and deeply affect socio-economic expectations due to the low power density of this energy source and the high energy intensity of the passenger transportation by car in the society.

This contribution is an embryonic study framework to integrate into the MuSIASEM approach (Multi-Scale Integrated Analysis of Societal and Ecosystem Metabolism) a standardized LCA applied to second generation's bio-ethanol, intended to be used as a fuel for local road transportation, from energy crop (Giant reed) cultivated and processed in the administrative scale of Campania Region.

### **3. The MuSIASEM toolbox**

The Multi-Scale Integrated Analysis of Societal and Ecosystem Metabolism (MuSIASEM) makes it possible to develop an analytical toolkit providing an effective assessment when dealing with the complex analysis of the sustainability of systems [2] [3] [4], and producing effective information for several actors (policy makers, stakeholders, consumers). MuSIASEM integrates two non-equivalent views of the system under analysis: the outside view and the inside view. In this study the inside view is about the bioethanol production system (techno-economic system) to be integrated in the regional territory with its bio-physical capacity and societal structure (outside view). Such framework should be suitable to generate analysis of scenarios capable of addressing three criteria of performance: feasibility, viability and desirability [5]. Feasibility is in relation to external constraints: In this study, we consider the land (supposed marginal) required for energy crop, the structure of the regional agricultural sector (as the source fund of the necessary labour force), and the environmental impacts at global and local scale. Viability is in relation to internal constraints (economic costs and technical coefficients of the bioethanol production system). Desirability is in relation to the capability of attaining the expected goals at Regional scale, i.e. the degree at which the bioethanol production system could produce new jobs and could guarantee the energy supply for transportation needs.

### **4. LCA integrated in the MuSIASEM toolbox**

LCA study was conceived to be integrated in the sphere of feasibility in order to evaluate the environmental impacts of the bioethanol production system. The LCA was applied according to standard procedures (and ISO 14040-44: 2006) and implemented by means of SimaPro 8.0.3 software coupled with ReCiPe H Ver 1.08 as midpoint hierarchic impact assessment method and EcoInvent database (Ver 2.0). The functional unit was set as 1 MJ of power delivered to passenger cars. For bioethanol production, the system boundary includes biomass production, transport of biomass to an ethanol plant, ethanol conversion, transport and distribution of ethanol, and final use in the ethanol fuelled vehicle.

Primary data were available for the inventory of the *Arundo donax* feedstock cultivation stage. The ethanol conversion plant and related emissions were modeled calibrating the "Ethanol, from wood" record in EcoInvent database, according to specific advanced pre-treatment, enzymatic hydrolyses and fermentation efficiencies retrieved for *Arundo donax* from pertinent scientific literature. Similarly to EcoInvent ligno-cellulosic ethanol, also the conversion plant in this study appeared energy self-sufficient (steam and electricity), by combustion of unconverted solids (lignin cake, etc.) in cogeneration combined heat and

power (CHP), with an electricity surplus to the national grid. For this reason, in respect of the multifunctional process investigated, the impacts of bioethanol production chain have been allocated, on exergy basis, for 97% to bioethanol produced and for 3% to the co-produced electricity.

This study conceived the bioethanol production system functional for the Regional needs in transportation energy. In addition sensitivity of different transport distances to the overall LCA outcomes has been largely demonstrated. According to the International Energy Agency (IEA-Bioenergy), one considers maximum economic transport distance of biomass for bioenergy is limited to 100 km.

## 5. Conclusion

The preliminary results induce to draw some conclusions revealing poor performances of the bioethanol production system for each of the three levels considered.

- i) The huge land requirement to fill the high Regional fuel demand, based on 2020 EU target, appears unfeasible due to the low power density of the overall production chain ( $0.17 \text{ kW m}^{-2}$ ). This data is cause for reflections about the concept of marginal lands.
- ii) Nevertheless the giant reed crop has been conceived as a low input crop management, the most impact categories had worse performance than petrol procurement and utilization, acting mainly at local scale.
- iii) The mild capability of soil carbon storage detected for giant reed cultivation is paltry compared to the carbon emitted by transportation at regional scale.
- iv) The farming sector of Campania Region is in a phase of progressive ageing and barely the low income expected from bio-energy crops would attract younger people.
- v) High technical coefficients (economic costs and energy investment) were detected, both for agricultural phase and processing phase of feedstock.
- vi) Very limited social and monetary benefits are expected, due to the low margin for farmers and to the small potential for creating new jobs in the energy sector.

## 6. Acknowledgements

The authors gratefully acknowledge the financial support received from the PON01\_01966 “ENERBIOCHEM” (Integrated agro-industrial chains with high energy efficiency for the development of eco-compatible processes of energy and biochemicals production from renewable sources and for the land valorisation) Project no. 881/Ric - Programma Operativo Nazionale (PON) under the supervision and control of the Italian Ministry for University and Scientific Research (MIUR), D. Prot N. 1/Ric 18/01/2010.

## 7. References

- [1] Wiloso, E.I., Heijungs R. and de Snoo G.R., ‘LCA of second generation bioethanol: a review and some issues to be resolved for good LCA practice’, *Ren. & Sust. Energy Rev.* 16 (2012) 5295-5308.
- [2] Giampietro, M., Mayumi, K. and Sorman, A.H., ‘The Metabolic Pattern of Societies: Where economists fall short’, (Routledge, Abingdon, 2012).
- [3] Giampietro, M., Mayumi, K. and Sorman, A.H., ‘Energy Analysis for a Sustainable Future: Multi-Scale Integrated Analysis of Societal and Ecosystem Metabolism’, (Routledge, Abingdon, 2013).
- [4] Giampietro, M., Aspinall, R.J., Ramos-Martin, J. and Bukkens, S.G.F. (Eds.) ‘Resource Accounting for Sustainability Assessment: The Nexus between Energy, Food, Water and Land use’, (Routledge, Abingdon, 2014).
- [5] Giampietro, M. and Bukkens, S.G.F., ‘Analogy between Sudoku and the multi-scale integrated analysis of societal metabolism’, *Ecol. Informatics*, 26, Part 1 (2015) 18-28.

# Combining frontier analysis and Exergetic Life Cycle Assessment towards identification of economic-environmental win-win situations on dairy farms

Sophie Huysveld<sup>1,2</sup>, Jef Van Meensel<sup>2</sup>, Steven De Meester<sup>1</sup>, Veerle Van linden<sup>2</sup>, Nico Peiren<sup>2</sup>, Hilde Muylle<sup>2</sup>,

Ludwig Lauwers<sup>2,3</sup> and Jo Dewulf<sup>1</sup>

*1 Research Group EnVOC, Department of Sustainable Organic Chemistry and Technology,*

*Faculty of Bioscience Engineering, Ghent University, Coupure Links 653, 9000 Gent, Belgium*

*2 Institute for Agricultural and Fisheries Research (ILVO), Burg. Van Gansberghelaan 115, 9820 Merelbeke, Belgium*

*3 Department of Agricultural Economics, Faculty of Bioscience Engineering, Ghent University,*

*Coupure Links 653, 9000 Gent, Belgium*

*E-mail contact: [sophie.huysveld@ilvo.vlaanderen.be](mailto:sophie.huysveld@ilvo.vlaanderen.be)*

## 1. Abstract

*In light of environmental concerns about livestock farming and high pressure on profit margins in milk production, dairy farmers face the challenge to produce in an environmentally sustainable, yet competitive way. In this study, we aim to investigate whether and how economic-environmental win-wins can be achieved for dairy farms in the region of Flanders (Belgium). From an environmental viewpoint, we focus on natural resource use (land, water, minerals, fossil resources, etc.), quantifying it through Exergetic Life Cycle Assessment (ELCA). Combining ELCA and frontier analysis, we assess economic and environmental performances of 127 specialized dairy farms by positioning these farms against a best practice frontier.*

## 2. Introduction

During the past decades, intensification of agricultural systems in order to improve yields has coincided with an increased material and energy throughput and has been accompanied by environmental burdens (greenhouse gas emissions, eutrophication, etc.). In addition to rising environmental concerns, farm income comes more and more under pressure due to multiple factors, e.g. increasing input costs, unfavourable weather conditions, increased competition and pressure on output prices, etc. Maintaining competitiveness in harmony with the environment is a major challenge and research into farm-specific optimization paths is needed. In this study, to support the economic and environmental improvement of dairy farms, we combine frontier analysis and Exergetic Life Cycle Assessment (ELCA).

Frontier analysis is used to measure technical, economic and environmental performances by positioning farms against a best practice frontier, which is established using production-theoretical principles. Production theory considers the technical relationship between inputs and outputs of a production process, being the production function [1]. Fully technically efficient farms are located on the best practice frontier. Technical efficiency reflects the ability to obtain maximal output(s) from (a) given input(s) or to use minimal input(s) to obtain (a) given output(s) [2]. By linking the production function to economic and environmental performances, economic and environmental benchmarks can be identified on the best practice frontier. Using frontier analysis in this study, we benchmark actual performance levels of dairy farms with the optimal performance levels in order to identify win-win possibilities and trade-off situations.

In the light of the trend towards more intensively managed high input/high output systems, resource use analysis is very relevant to support whole-farm strategies for economic-environmental optimization. In assessing overall resource consumption of processes and full production chains, the concept of *exergy* is particularly useful. The exergy concept is put forward as an appropriate quantifier for both material and energy flows in one single scale (joules of exergy ( $J_{ex}$ )). The exergy concept originates from the second law of thermodynamics that postulates that every process transforms resources into work, heat, and/or products, by-products and wastes, and generates entropy. The sum of the exergy embodied in these outputs is lower than the total input of exergy in the resources, because part of the initial exergy dissipates through irreversible entropy production. The quality of resources thus decreases in every transformation step. The exergy content of a resource equals the minimum work necessary to produce that resource in its specified state (temperature, pressure) and composition in a reversible way from common materials in the reference environment [3]. Integrating the exergy concept in LCA results into Exergetic Life Cycle Assessment (ELCA), which is used to calculate a production chain's resource footprint.

Hoang and Rao proposed to integrate cumulative exergy consumption in frontier analysis to calculate the environmental efficiency of agricultural production in 29 OECD countries [4]. In this study, we aim to investigate, at farm level, whether and how economic-environmental win-wins can be achieved for dairy farms in the region of Flanders (Belgium). In previous work [5], we showed how Exergy Analysis (process level) and ELCA (life cycle level) can be used to identify environmental improvement options for dairy farms from a resource efficiency viewpoint. For that purpose, we assessed the resource consumption of one intensive confinement-based dairy farm. In this study, we calculated the profit and the resource footprint of 127 specialized dairy farms to provide a broader view on their resource consumption in relation to their economic performance.

### **3. Materials and methods**

Inventory data of 127 specialized dairy farms in the region of Flanders (Belgium) were retrieved from their farm accountancy files for a one-year period in 2010-2011. These accountancy files are essential for the calculation of the annual economic result but they also contain information expressed in physical units. Data of the farm supply chains were mainly retrieved from the ecoinvent v2.2 database, in addition to other literature sources. The boundary of our study included the production chain from cradle to dairy farm gate.

#### *Exergetic Life Cycle Assessment (ELCA)*

The exergy-based life cycle impact assessment method *Cumulative Exergy Extraction from the Natural Environment (CEENE)* [6] was applied to calculate the life cycle's resource footprint. The CEENE method is coupled to the life cycle inventory database *ecoinvent*, which contains resource use data for several thousands of processes. Calculation of CEENE values involves quantification of the total exergy contained in all types of natural resources extracted from the environment throughout the life cycle. The CEENE method subdivides natural resources into eight categories: abiotic renewable resources (hydropower and wind), land resources, nuclear energy, metals, fossil resources, water, minerals and atmospheric resources. The way in

which the original CEENE v2007 method [6] accounted for land resources was modified, leading to CEENE v2013 [7], which was applied in our study.

### *Frontier analysis*

To assess the production frontier and calculate efficiency scores, we use nonparametric data envelopment analysis (DEA). Data envelopment analysis involves the use of linear programming to construct a nonparametric piecewise frontier over the data and calculates efficiency scores relative to this frontier [2]. Economic and environmental efficiency scores are determined by linking the production function to economic and exergy (CEENE) coefficients. Focus is on input oriented efficiency measurement that reflects the ability of using minimal amounts of inputs to obtain a given amount of output.

## **4. Results**

Figure 1 shows the resource footprint of 127 specialized dairy farms in function of their profit. As we observe no clear association between resource footprint and profit, but we observe farms that perform well from both an economic and environmental point of view, this figure justifies to search for economic-environmental win-wins and trade-offs using frontier analysis. More detailed results on the share of the different resource categories and results of the frontier analysis will be shown during the presentation at the conference.

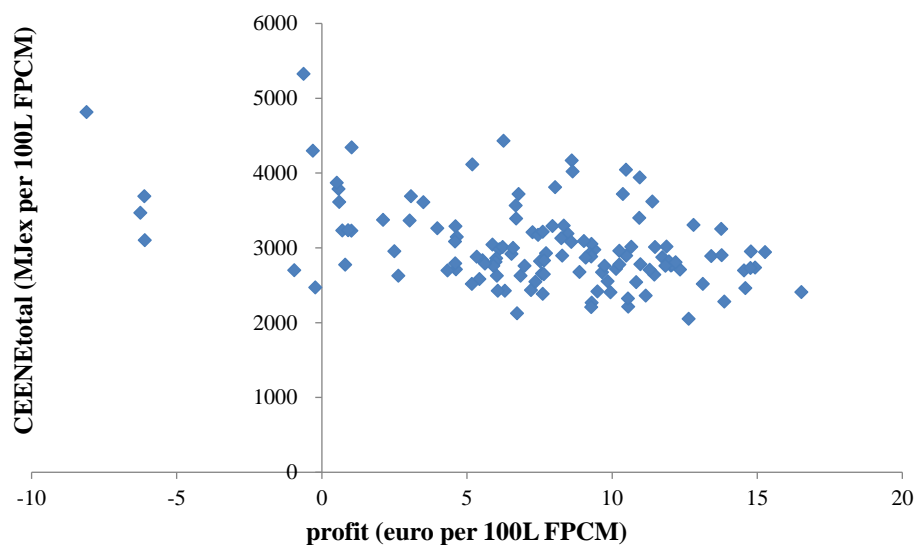

*Figure 1: The resource footprint in terms of CEENEtotal of 127 specialized dairy farms in the region of Flanders (Belgium) in function of their profit*

## **5. Conclusion and perspectives**

With this study, we provide an overall view on the resource consumption of specialized dairy farms in Flanders in relation to their economic performance. Future research could focus on the inclusion of other environmental burdens, such as greenhouse gas emissions, eutrophication and acidification.

## 6. References

- [1] Van Meensel, J., 'Farm-specific decision support for economic-environmental trade-off analysis using production-theory-based methods', PhD thesis (University Press, Gent, 2011).
- [2] Coelli, T.J., Rao, D.S.P., O'Donnell, C.J., and Battese, G.E., 'An Introduction to Efficiency and Productive Analysis', 2nd Edn (Springer, New York, 2005).
- [3] Szargut, J., Morris, D.R., and Steward, F.R., 'Exergy analysis of thermal, chemical and metallurgical processes', (Hemisphere Publishing Corporation, Berlin, 1988).
- [4] Hoang, V.N. and Rao, D., 'Measuring and decomposing sustainable efficiency in agricultural production: A cumulative exergy balance approach', *Ecol. Econ.* 69 (9) (2010) 1765-1776.
- [5] Huysveld, S., Van linden, V., De Meester, S., Peiren, N., Muylle, H., Lauwers, L., and Dewulf, J., 'Resource use assessment of an agricultural system from a life cycle perspective - a dairy farm as case study ', *Agric. Syst.* 135 (2015) 77-89.
- [6] Dewulf, J., Bösch, M.E., De Meester, B., Van der Vorst, G., Van Langenhove, H., Hellweg, S., and Huijbregts, M.A.J., 'Cumulative Exergy Extraction from the Natural Environment (CEENE): a comprehensive Life Cycle Impact Assessment method for resource accounting', *Environ. Sci. Technol.* 41 (24) (2007) 8477-8483.
- [7] Alvarenga, R.A.F., Dewulf, J., Van Langenhove, H., and Huijbregts, M.A.J., 'Exergy-based accounting for land as a natural resource in life cycle assessment', *Int. J. Life Cycle Assess.* 18 (5) (2013) 939-947.

# Life cycle social sustainability assessment convenience food: Ready-made meals

Ximen Schmidt Rivera and *Adisa Azapagic*

School School of Chemical Engineering and Analytical Science, The Mill, Sackville Street,  
University of Manchester, Manchester M13 9PL, UK

E-mail contact: *adisa.azapagic@manchester.ac.uk*

## 1. Abstract

*The global ready-made meals market is growing fast, estimated to be worth \$1.3 trillion by 2016. At present, the USA and the UK hold the largest market share in the world. This paper considers the sustainability of the ready-made meals sector in the UK, with a focus on social aspects. Taking a life cycle approach, the sustainability is evaluated using social sustainability indicators developed as part of this research. A range of the most popular ready-made meals in the UK are considered in the Italian, Chinese, Indian and British cuisines. The results suggest that wages and forced and child labour are critical social impacts in the agriculture, worker injuries and fatalities in the manufacture of the meals, while food costs and health are important from the consumer point of view. Options for improvements of social impacts are also discussed.*

## 2. Introduction

The convenience food sector is growing rapidly, with the value of the global ready-made meals market predicted to increase from \$1.11 trillion in 2011 to \$1.3 trillion by 2016 [1]. At present, the USA and the UK hold the largest market share in the world, estimated at £7.2 bn [2] and £2.6 bn [3], respectively. In the UK, a third of the British adult population consumes ready-made meals once a week, while in countries such as France only 15% of adults buy prepared food [3]. Overall, 8.8 kg of ready-made meals are consumed in the UK per capita per year [4]. Yet, little is known about the sustainability of the ready-made meals sector, particularly social aspects. Therefore, this paper aims to evaluate the social sustainability of the ready-made meals sector in the UK, using a life cycle approach. A range of most popular ready-made meals in the Italian, Chinese, Indian and British cuisines are considered.

## 3. Methodology

The social sustainability is assessed on a life cycle basis, using a set of social sustainability indicators developed in this research. The indicators consider three major groups of stakeholder: employees, local communities and consumers (Table 1). For each indicator, the level of risk across the life cycle has been estimated, following the criteria in [ ].

All life cycle stages are considered, including agriculture to produce meal ingredients, meal manufacturing, retail and consumption. The analysis is based on the most popular meals in the UK across the above mentioned cuisines, representing more than 80% of the market sales by value (Figure 1). Where possible, the assessment is specific to the ready-made meal sector but, where data were not available, it is based on the food and drink sector and/or the UK as a country.



<b>Employees</b>	
<i>Employment</i>	<i>Working hours</i>
<i>Freedom of association</i>	<i>Forced labour</i>
<i>Collective bargaining</i>	<i>Equal opportunities/discrimination</i>
<i>Child labour</i>	<i>Health and safety</i>
<i>Wages</i>	
<b>Local communities and consumers</b>	
<i>Community and consumer engagement</i>	<i>Consumer health and food costs</i>

Table 1: Social sustainability indicators considered in the study

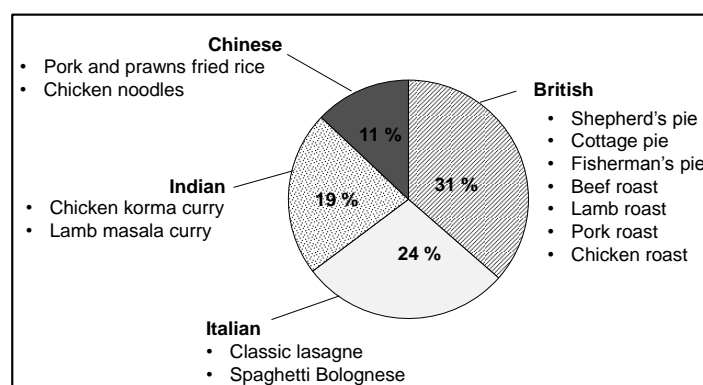

Figure 1: Market share of most popular ready-made meals in the UK considered in the study

## 4. Results

### 4.1 Employees

Table 2 summarises the social sustainability hotspots across the supply chain for the employees in the sector. As can be seen, agriculture is a critical stage in the life cycle of ready-made meals for several indicators, particularly child labour. Worldwide, agriculture has a high rate of child labour, estimated at around 60% [5]. Therefore, the risk of child labour is considered very high, particularly for the parts of supply chain outside the UK, such as some of the ingredients imported from abroad. It is also possible that child labour may be used in the UK because of people smuggling and trafficking issues.

This is also one of the reasons for a high risk with respect to the wages in the agricultural sector which are 30% lower than the average for the UK. Working hours are 11% above the UK average and are classed as a medium risk. On the other hand, agriculture provides 12% of the employment in the whole agro-food supply chain and has low fatal injuries. However, the latter represents a very high risk in the manufacturing sector, which contributes 18% of the total work-related fatal injuries in the UK [5]. At the same time, this sub-sector provides 12% of total UK jobs and has 5% higher wages than the UK average [5]; however, the working hours are also higher (4%) than the average.

Social indicators	UK/sectoral level	Agriculture	Manufacture	Wholesale & retail	Transport & storage
Contribution to employment					
Freedom of association					
Collective bargaining					
Child labour					
Wages					
Working hours					
Forced labour					
Equal opportunities					
Fatal injuries					

Very high	High	Medium	Low	No data

Table 2: Social hotspots for employees in the ready-made meals supply chain

The wholesale and retail sectors each provide 15% of the total employment in the UK but represent a high risk for the wages as they pay 30% lower salaries than the UK average. Finally, transport and storage contribute 7% of the total UK employment but have 15% higher fatal injuries and 7% higher working hours than the UK average.

For equal opportunities, the UK is a low risk country [5]. However, based on the global gender gap, it is ranked only 18<sup>th</sup>, behind countries such as Nicaragua, Lesotho and South Africa. In the UK food and drink sector, 33% of women are considered to be in forced labour [6]. Forced labour is not only an issue for women but also for men. In the UK, there is a high risk of forced labour, particularly because of human trafficking and modern slavery. Between 3000 and 5000 people have experienced some form of forced labour [6]. Some of the malpractices include indiscriminate wage deductions and charges, overwork, lack of contract, passport retention, threats and bullying. In addition to human trafficking, another reason that the food sector is vulnerable to forced labour is its seasonality and use of migratory workforce: workers often consider these jobs as temporary and are willing to assume poor working condition for a short period of time [7].

For the freedom of association and collective bargaining rights, the UK and the food and drink sector are ranked as a medium risk [5]. For example, between 1999 and 2008, the number of strikes has decreased by 30% across all UK sectors. In the same period, the manufacturing sector saw a reduction of 95%. This could mean that either the work conditions have been stable or improving, or that these particular rights have been oppressed, but there are no data to support either supposition. However, it is important to note that the data refer to the period just before the economic crisis, so that the numbers might have changed.

#### 4.2 Local communities and consumers

The UK food sector is involved in a range of community and consumer engagement initiatives to raise awareness related to food and health, to attract young people into the sector, etc. Some examples include nutrition and healthy-eating initiatives, aimed at reducing the content of fat, sugar and salt in food and informing consumers on their content through labelling [7]. This has been driven by the increasing rate of diet-related chronic diseases (DRCD), such as obesity and diabetes, cardiovascular diseases, hypertension, strokes, osteoporosis, dental diseases and certain types of cancer. For example, in 2011, a quarter of the British adult population was obese and a third was overweight [8]. The increase in DRCD is causing a rise in the national health costs because of the need for treatment, disability support, information and prevention campaigns. For example, 7.4% of the UK's annual health budget - £5.8 billion - is spent by NHS on food-related illnesses [9]. Several factors have contributed to the rise of DRCD, including modern lifestyle and high consumption of convenience food [10]. For these reasons, it is expected that the DRCD will more than double by 2020 [11].

In addition to health issues, consumers are also affected by food costs which increased sharply since the onset of the recession in 2007, with the processed food sector being one of the most affected [12]. A recent survey showed that 80% of consumers are worried about food prices and 60% have changed their shopping options because of the constant rise in food prices [13]. The most affected are the lower-income earners and households with children. As food affordability is a key factor in food poverty, the rise in food prices also affects the welfare of the population as consumers tend to buy cheaper food which is often less healthy.

#### 5. Conclusions and recommendations

Based on the findings of this work, the following recommendations can be made to the key stakeholders to improve the social sustainability in the ready-made meals sector:

- Government policy should encourage manufacturers to work with the stakeholders across the whole supply chain, including suppliers and consumers, to improve the social sustainability in the sector.
- Government and industry should ensure that wages in the agricultural and retail sectors are brought in line with the UK average. Robust policies should be developed to eradicate forced and child labour in the agricultural sector.
- The food manufacturing sector should formulate a clear strategy and set ambitious targets to minimise worker injuries and fatalities as well as to improve nutritional quality of food and reduce the amount of added salt, sugar and fat during processing.
- Government's advice to the public to "buy British" should not be made indiscriminately as in some cases it is more sustainable to import certain food than use local produce, despite long-range transport. Thus, the implications for social sustainability of imported vs local food should be understood better before providing advice to the consumer.
- The proliferation of different food labels only serves to confuse the consumer so that the industry and the government should develop a single, easy-to-understand food labelling system to improve awareness and enable more informed consumer choices. The labelling should be unified across different manufacturers.
- An appropriate communication strategy as well as educational programmes should be developed in collaboration between the industry, the government and consumer groups to help consumers make more sustainable food choices, particularly with respect to convenience food.

## 6. References

- [1] Key Note (2013). Market report plus 2013: ready meals. Teddington, UK.
- [2] Sheely, M. (2008). Global adoption of convenience foods. *Am. J. of Agricultural Economics* 90(5) 1356-1365.
- [3] Mintel (2013). Prepared meals – UK – May 2013. <http://academic.mintel.com/display/664508>.
- [4] Millstone, E. and Lang, T. (2008). *The Atlas of food: who eats what, where, and why* (2nd ed.). Earthscan: London.
- [5] SHDB (2010). Social Hotspot Database. <http://socialhotspot.org>.
- [6] ILO (2014). Database on Labour Statistic. LABORSTA Internet. <http://laborsta.ilo.org>.
- [7] University of Cambridge (2010). Value of food and drink manufacturing to the UK. University of Cambridge.
- [8] Skrivankova, K. (2014). *Modern slavery: how can we end forced labour in the UK?* York: Joseph Rowntree Foundation. [www.jrf.org.uk/publications/forced-labour-united-kingdom](http://www.jrf.org.uk/publications/forced-labour-united-kingdom).
- [9] Lalani, M. and Metcalf, H. (2012). *Forced labour in the UK: the business angle*. York: Joseph Rowntree Foundation.
- [10] CFA (2014). *Healthy Eating*. Chilled Food Association.
- [11] Defra. (2014). *Food statistics pocketbook, 2013 update*. [www.gov.uk](http://www.gov.uk).
- [12] Scarborough, P., Bhatnagar, P., Wickramasinghe, K. K., Allender, S., Foster, C. and Rayner, M. (2011). The economic burden of ill health due to diet, physical inactivity, smoking, alcohol and obesity in the UK: an update to 2006–07 NHS costs. *Journal of Public Health* 33(4) 527-535.
- [13] McPherson, K. (2014). Reducing the global prevalence of overweight and obesity. *The Lancet* 384(9945) 728-730.
- [14] WHO/FAO (2003). *Diet, nutrition and the prevention of chronic diseases*. Geneva: WHO/FAO.
- [15] Downing, E., and Harker, R. (2012). *Food prices and affordability - commons library standard note*. [www.parliament.uk/business/publications/research/briefing-papers/SN06436/food-prices-and-affordability](http://www.parliament.uk/business/publications/research/briefing-papers/SN06436/food-prices-and-affordability).
- [16] WHICH? (2013). *Cutting back and trading down: the impact of rising food prices*. WHICH?, 19 November 2013. [www.staticwhich.co.uk/documents/pdf/which-report-cutting-back-and-trading-down-the-impact-of-rising-food-prices-341023.pdf](http://www.staticwhich.co.uk/documents/pdf/which-report-cutting-back-and-trading-down-the-impact-of-rising-food-prices-341023.pdf).

# LCC, S-LCA and LCSA in food and energy sectors: lessons from scientific literature

Andrea, Fedele<sup>1</sup>; Anna, Mazzi<sup>1</sup>; Filippo, Zuliani<sup>1</sup>; Antonio, Scipioni<sup>1</sup>

ICESQA (Quality and Environmental Research Centre) - University of Padova - Department of Industrial Engineering,  
via Marzolo 9, 35131 Padova, Italy

E-mail contact: [scipioni@unipd.it](mailto:scipioni@unipd.it)

## 1. Abstract

*Product and service sustainability assessment is a process that includes together environmental, economic and social evaluations. In the global market this evaluations are coming increasingly important from a conscious consumer perspective. This is especially true for food and energy products in particular as a consequence of the new alternatives proposed in the recent times (e.g. organic food or renewable energy sources). This study summarizes results from a literature review aiming at delineating the development of Life Cycle Costing, Social-Life Cycle Assessment and Life Cycle Sustainability Assessment methodologies in the food and energy sectors. Results underlines the limited application of these life cycle analysis approach in these fields, despite well-developed environmental Life Cycle Assessment, as demonstrated by the great number of scientific paper published, especially in the last years.*

## 2. Introduction

In the recent developments of the concept of global market, methodologies to evaluate the sustainability characteristics of a product, service or product have been studied and implemented [1]. The reference approach for all life cycle analysis comes from the standardized approach developed for environmental investigation, the life cycle assessment (LCA) analysis. Despite that, the entire scientific community has raised the need to evaluate also social and economic aspects in a life cycle perspective for a complete sustainability evaluation of a product and service [2]: the common structure suggested for LCA has been so adopted also for life cycle costing (LCC), social life cycle assessment (S-LCA) and life cycle sustainability assessment (LCSA). Starting from these considerations, it is easy to understand the reason of the great number of scientific researches published regarding the implementation of LCA methodology in the context of the environmental sustainability analysis of products and services [3].

These innovative approaches towards sustainability evaluation have been taken in consideration in a significant way also in the food and energy sectors. The public awareness about sustainability assessment in a life cycle perspective is increasing, including demand for more ecological and ethical standards when selecting products [4].

Considering the food and energy sectors, the aim of this study is to delineate the development and the implementation of the LCC, LCSA and S-LCA methodologies through a literature review of scientific papers. The objective of the research is to underline what are the specific food and energy products and services on which case studies have been applied, to suggest possible future developments.

### 3. Method and Results

#### 3.1 Research methodology

An exploratory qualitative research has been conducted with a bibliographic research review. Starting from the experience of LCA development, the research has been made on three relevant editors which published many researches in the environmental sustainability field: Springer, Elsevier and Wiley. Working on the dedicate research engine, this work has been performed searching specific keywords on books, texts and on relevant scientific papers published in the period 1980-2015. The paper or book chapter sections analyzed have been the “Title”, “Abstract” or “Keywords”. The specific keywords chosen for the literature research were “life cycle costing”, “social life cycle assessment”, “life cycle sustainability assessment” and the relative acronyms combined, respectively, with the words “food” and “energy”. All publications founded have been singularly analyzed considering the following features: source, year of publication, research field (LCA, LCC, S-LCA, LCSA or combination of them) and principal topic (sector of application or specific product/service/process analyzed).

#### 3.2 Results

The general result is that scientific literature is not yet well developed in the topics analyzed and although many papers underline the relevance of these approaches for product analysis, specific case studies and applications are not so common. Another interesting result is relative to LCC applications: all studies are relative to the entire product/services cost but a well-defined common approach is not shared. S-LCA and LCSA approaches are still under development and only a few case studies can be identified although indications for a common methodology are published and shared inside the scientific community [5] [6] [1]. The analysis shows that this conclusion is particularly valid for agricultural and food production sectors unlike the energy one. Considering the food sector, the research has given 25 publications (tab. 1), of which 17 papers published in scientific journal. The analysis shows that the development of the researches on the food sectors started significantly five years ago, with almost the 90% of the publication in the period 2011-2015. The highest number of works is regarding the development of LCC and S-LCA. Only 4 works have developed a complete sustainability analysis through an LCSA approach.

The greatest number of publications has been founded in the International Journal of Life Cycle Assessment (6 papers) and in the Journal of Cleaner Production (5 papers).

1:

Topic	Number of publications	Life cycle approach	Specific applications
Food Packaging	3	LCC, SLCA	
Specific food product	10	LCC, SLCA, LCSA	Sugar, wine, milk, olive, citrus, fish, animals
End of life	4	LCC, SLCA, LCSA	Waste management, disposal, food recycling
Other product/processes linked to food sector	8	LCC, SLCA	Chemical product, supply chain, general methodological approach to food sector

*Table*

*Topics developed in the food sector for LCC, S-LCA and LCSA*

Results coming from the energy sector analysis show a higher number of scientific research published compared to the food sector: 82 papers published, in the time period considered (tab. 2). A significant development on these research topics, similar to the food case, started in the last years, with a percentage of publication of about 65% in the period 2011-2015. Also in this case the results underline a relevant development of economic studies, with 61 LCC analysis founded; despite this, a relevant number (16) of LCSA applications has been founded and only 5 application of S-LCA methodology. Not so many applications have been founded for case studies on specific food product (e.g. sugar, milk, etc.). More than half of the papers were published in the following journals: Applied Energy, Energy, Energy and Buildings, Renewable and Sustainable Energy Reviews (Elsevier) and International Journal of LCA (Springer).

2:

Topic	Number of publications	Life cycle approach	Specific applications
Alternative electric energy production	18	LCC, SLCA, LCSA	Energy from wind, biomass, geothermal and solar source, photovoltaic, nuclear power, hybrid energy systems
Traditional and alternative fuels	26	LCC, SLCA, LCSA	Gasoline, diesel oil, biodiesel, biogas, hydrogen, cassava-based ethanol, biogas from algae, bioethanol, gas storage
Buildings and component	15	LCC, LCSA	Net-zero, retrofitting and commercial buildings, residential furnaces and boilers, smart window
Specific energy product/process	15	LCC, SLCA, LCSA	Insulation, electronic devices and motor, clothes dryers, fan, alternators, wind turbine, fluorescent lamp, WEEE, energy storage system

*Table*

*Topics developed in the energy sector for LCC, S-LCA and LCSA*

Other less relevant results are relative to traditional electricity production and automotive sector.

Considering the results obtained and with objective to improve them, the literature research has been also implemented using only the words LCC, SLCA and LCSA, without other search filters: the result has been that other 9 publications of life cycle methodologies (S-LCA and LCSA) in the energy sector have been founded.

#### **4. Conclusion**

This type of investigations allows us to understand in a precise way the development of the scientific research on these fields: considering the development of LCA in the food and energy sector, it is possible to declare that the number of papers founded about LCC, S-LCA and LCSA is still small. The results of the analysis shows that a consistent number of LCC, S-LCA and LCSA analysis are combined in the same study with LCA applications and similar (e.g. carbon footprint), in particular in the food sector, where more than half studies reported this combination. Besides LCA applications, also LCC analysis is developing in the recent years, in line with the LCA approach [7], but cost calculation methods are not similar in different studies.

As possible future developments, starting from existing environmental evaluations appears relevant, first of all because sharing a common methodology (in particular for S-LCA and LCSA applications, especially in terms of indicators) in line with the last principal shared methodological approaches. This can allow us to obtain more complete results in terms of sustainability evaluation and can give more consistence also to the comparative analysis, for example regarding different paths for food production, and different alternative energy sources.

## 5. References

- [1] Ciroth, A., Finkbeiner, M., Hildenbrand, J., Klöpffer, W., Mazijn, B., Prakash, S., Sonnemann, G., Traverso, M., Ugaya, C.M.L., Valdivia, S., Vickery-Niederman, G., 'Towards a Life Cycle Sustainability Assessment' (UNEP/SETAC Life Cycle Initiative, 2011).
- [2] Finkbeiner, M., Schau, E.M., Lehmann, A., Traverso, M., 'Towards Life Cycle Sustainability Assessment', *Sustainability* 2 (2010) 3309-3322.
- [3] Zamagni, A., 'Life cycle sustainability assessment', *Int J Life Cycle Assess* 17 (2012) 373-376.
- [4] Smith, J., Barling, D., 'Social impacts and life cycle assessment: proposals for methodological development for SMEs in the European food and drink sector', *Int J Life Cycle Assess* 19 (2014) 944-949.
- [5] Benoît Norris, C., Traverso, M., Valdivia, S., Vickery-Niederman, G., Franze, J., Azuero, L., Ciroth, A., Mazijn, B., Aulisio D., 'The Methodological Sheets for Subcategories in Social Life Cycle Assessment (S-LCA)' (UNEP/SETAC Life Cycle Initiative, 2013).
- [6] Mattioda, R.A., Mazzi, A., Canciglieri, O. J., Scipioni, A., 'Determining the principal references of the social life cycle assessment of products', *Int J Life Cycle Assess* (2015) DOI 10.1007/s11367-015-0873-z.
- [7] Heijungs, R., Settani, E., Guinée, J., 'Toward a computational structure for life cycle sustainability analysis: unifying LCA and LCC', *Int J Life Cycle Assess* 18 (2013) 1722-1733.



# Applying Social Life Cycle Assessment in the Thai Context: Challenges from the sugar industry

*Jittima Prasara-A<sup>1</sup>, Shabbir H. Gheewala<sup>2,3</sup>*

<sup>1</sup>*Faculty of Environment and Resource Studies, Maharakham University, Maharakham, Thailand*

<sup>2</sup>*Joint Graduate School of Energy and Environment, King Mongkut's University of Technology Thonburi,*

*Bangkok, Thailand*

<sup>3</sup>*Centre of Energy Technology and Environment, Ministry of Education, Bangkok, Thailand*

*E-mail contact: jittima.p@msu.ac.th*

## 1. Abstract

*Social Life Cycle Assessment (S-LCA) was tested vis-à-vis its applicability for the Thai sugar industry sector. The main challenges in applying S-LCA in the Thai sugar industry sector are difficulty in data collection and different interpretation of social indicators for different people. It was difficult to get reliable information about some sensitive social issues for the workers because data were collected through the sugar factory as most sugarcane producers are contracted with the sugar factories. Site visits and interviews with labourers working in sugarcane farms were used to validate the data. The suggested social subcategories for the Thai sugar industry are shown in this paper. The final results of this study are used to recommend some practical ways in conducting S-LCA for the Thai sugar industry sector.*

## 2. Introduction

Sugar plays an important role in the Thai economy. In 2012, Thailand was the second largest sugar exporter in the world [1]. This implies that a large amount of sugar is produced annually. To achieve sustainability in the sugar industry, all environmental, economic and social dimensions needed to be considered. Some previous studies assessed environmental and economic performances of sugar in Thailand. However, the assessment of its impacts on the social component is limited. In this study, the tool “Social Life Cycle Assessment” (S-LCA) was used to test its applicability for the Thai sugar industry sector. Data were collected in the northeastern part of Thailand as it is the largest sugarcane producer in the country. S-LCA is a tool used to assess the social and socio-economic aspects of products and their potential positive and negative impacts along their life cycle encompassing extraction and processing of raw materials; manufacturing; distribution; use; re-use; maintenance; recycling; and final disposal. It could be used to complement Environmental Life Cycle Assessment [2]. However, data from different stakeholders such as workers, consumers, local community, society and value chain actors along all stages in product/service's life cycle are required.

## 3. Methodology

### 3.1 Selection of social subcategories

The S-LCA was conducted following the guidelines for Social Life Cycle Assessment of Products of UNEP [2]. To find appropriate social subcategories to examine, the main subcategories from the relevant international standards/guidelines (namely Sustainability Assessment of Food and Agriculture systems, Roundtable on Sustainable Biomaterials, Global Bioenergy Partnership and Bonsucro) were selected by 83

stakeholders divided into 5 groups (including workers, consumers, local community, society and value chain actors) in the Nakhon Ratchasima province of Thailand during June 2015. In addition, an attempt was made to avoid people who share roles in more than one stakeholder groups in order to avoid biased opinion for each stakeholder group. They were asked to identify what are most important to them (from the list given). In addition, they were asked to identify the subcategories that are socially contributed (both positive and negative) by the sugar industry.

### *3.2 Data collection*

Before field data collection, the social hot spots of Thai sugar sector were assessed using the Social LCIA Method 0.9V0.01/Standard in SimaPro 8.0.4.24. It was found that the sugarcane production sector contributes about 84 percent of total impacts of the sugar industry. Therefore, field data collection was focused on sugarcane production. The main subcategories that are socially impacted are health & safety and labour rights & decent work.

#### *Data for sugarcane farmers*

Data for workers were collected by face-to-face interview of 71 sugarcane farm owners in April 2015. These were conducted by staff of the sugar factory because most farmers are contracted with the sugar factory. Thus the factory staff have direct contacts with the farmers. Site visits and interviews with labourers working in sugarcane farms were used to validate the data. Data used in this study were from farms that are contracted with one sugar factory in Nakhon Ratchasima, the province which produces the largest amount of sugarcane in the nation.

#### *Data for other stakeholders*

Data for labourers working in farms, consumers, local community, society and value chain actors were collected by interviewing 83 people (who were selected randomly) in the area nearby the studied sugar factory.

## **4. Results and Discussion**

Results of the social subcategories investigated are shown in Table 1. Note that the results shown in this table are major results for each indicator; and the indicators were designed and interpreted by the researchers of the project. Following the social hot spot analysis, field data collection was focused on sugarcane production. The main subcategories to focus on are health & safety and labour rights & decent work. For these subcategories, more detailed indicators were assessed. For other subcategories, stakeholders were asked to identify whether the sugar industry contributes to social impacts in these subcategories.

Stakeholders	Subcategories	Indicators	Results
Workers	Fair wage*	- Workers receive fair wage? - At least government regulated minimum wage (300B/day)?	- yes - no, about 200B/day but meal is provided at work
	Health and safety*	- Appropriate personal protective equipment supplied to and used by all workers? - All workers present on the field and/or mill have access to drinking water in sufficient quantity? - All workers present on the field and/or mill have access to first aid and provision for emergency response?	- No, not supplied in all farms. Sometimes, equipment supplied but not used by workers - yes  -yes
	Free of discrimination*	- Same wage for male/female for same task - percentage of male/female workers	- yes  - percentage of female are higher because more male workers work in other sector such as construction that pays higher wage
	Free of forced labour*	- Free of forced labour?	- yes
	Social benefits*	- Workers received social benefits?	- no
	Fair working hours	- Maximum hours worked not exceeding 60 hours per week? - Overtime work is voluntary and paid at premium rate?	- yes - yes
	Free of child labour	- Free of child labour?	- yes
	Freedom of association and collective bargaining	- Workers have freedom of association and collective bargaining?	- yes
	Satisfaction of job	- Workers are satisfied with job?	- mostly yes
Consumers	Health & safety*	Contributed by sugar industry?	- Some local consumers claim that sugarcane trash burning affects their health
	Consumer privacy	Contributed by sugar industry?	- yes
	End of life responsibility	Contributed by sugar industry?	- not identified
	Feedback mechanism	Contributed by sugar industry?	- not identified
	Transparency	Contributed by sugar industry?	- not identified
Local community	Local employment*	Contributed by sugar industry?	- yes
	Delocalization and migration*	Contributed by sugar industry?	- yes
	Safe & healthy living conditions*	Contributed by sugar industry?	- Some locals claim that sugarcane trash burning affects their health
	Access to material resources*	Contributed by sugar industry?	- yes
	Access to immaterial resources*	Contributed by sugar industry?	- yes
	Community engagement	Contributed by sugar industry?	- yes
	Respect of cultural heritage	Contributed by sugar industry?	- yes
	Respect of indigenous rights	Contributed by sugar industry?	- yes
Society	Secure living conditions	Contributed by sugar industry?	- not identified
	Contribution to economic development*	Contributed by sugar industry?	- yes
	Public commitments to sustainability issues*	Contributed by sugar industry?	- yes
	Free of corruption*	Contributed by sugar industry?	- not identified
	Technology development	Contributed by sugar industry?	- not identified
Value chain actors	Prevention & mitigation of armed conflicts	Contributed by sugar industry?	- not identified
	Water right*	None of water legitimately contested by other users?	Small number reported
	Land right*	None of land legitimately contested by other users?	Small number reported
	Fair competition*	Contributed by sugar industry?	- yes
	Promoting social responsibility*	Contributed by sugar industry?	- not identified
	Supplier relationships	Contributed by sugar industry?	- yes
Respect of intellectual property rights	Contributed by sugar industry?	- not identified	

Table 1: Results of impact categories investigated

Note: \*subcategories that are identified by stakeholders as being the most important to them

The suggested social subcategories that are applicable for the Thai sugar industry are those provided in the guidelines/standards and also identified important by the stakeholders. We deem that the main social issues that should be improved urgently are those identified as important by stakeholders, who are socially harmed by the industry (such as problems of canetrash burning that affects local health and safety, low wage, land and water rights). However, some social subcategories that are suggested in international standards such as prevention & mitigation of armed conflicts, free of corruption and respect of intellectual property rights may be less relevant to the Thai sugar industry sector. Results could be used to guide studies in similar topics in other agricultural sectors in Thailand.

## **5. Conclusion**

Based on the results of this study, it was concluded that S-LCA is applicable for the Thai sugar industry sector. However, difficulty in data collection and different interpretation of social indicators for different people are the main challenges. Careful explanation of the background of each social indicator examined to stakeholders is suggested to help avoid misinterpretation. Results suggest that social subcategories that need urgent improvement are problems of canetrash burning that affects local health and safety, low wages, land and water rights.

## **6. References**

- [1] Illovo Sugar. International Sugar Statistics. 2012 [cited 2014 27 February]; Available from: [http://www.illovosugar.co.za/World\\_of\\_sugar/Sugar\\_Statistics/International.aspx](http://www.illovosugar.co.za/World_of_sugar/Sugar_Statistics/International.aspx).
- [2] United Nations Environment Programme, Guidelines for Social Life Cycle Assessment of Products. 2009.

# Material Flow and Water Footprint Analysis of Cassava Starch Production Systems

Napat Jakrawatana<sup>1</sup> and Shabbir H. Gheewala<sup>2,3</sup>

<sup>1</sup>*School of Energy and Environment, University of Phayao, Phayao, Thailand*

<sup>2</sup>*The Joint Graduate School of Energy and Environment, King Mongkut's University of Technology Thonburi, Bangkok, Thailand*

<sup>3</sup>*Centre for Energy Technology and Environment, Ministry of Education, Thailand*

*E-mail contact: napat\_j@hotmail.com*

## 1. Abstract

*This research applied Material Flow Analysis to analyse raw material and water flow and use efficiency and loss through each process of the cassava starch production system. The conventional system is compared with an improved one that recycles water to increase starch recovery. The results show that water recycling can reduce loss and increase productivity by almost 10% as compared to the conventional one and can reduce almost 50% of water use in the processing step.*

## 2. Introduction

Cassava is a versatile plant that can be used for food, feed and fuel. Thailand is the top cassava product exporter in the world. In Thailand, over half of the cassava is used for starch production. About 44% is used for producing chips and pelleted cassava for animal feed and only 2% is available for ethanol production. The Renewable and Alternative Energy Development Plan (AEDP 2012-2021) has set a target to increase ethanol production from cassava. Cassava has been planned to be used for feedstock more than molasses in the future. The increasing demand of food, feed and fuel from cassava further underlines the need for increasing productivity and resource recovery as well as reducing losses in the cassava starch production system. This research applied the Material Flow Analysis method to analyse raw material and water flow and use efficiency and loss through each process of the cassava starch production system.

## 3. Method

This research applied Material Flow Analysis (MFA) as the main tool. MFA is an environmental accounting tool that traces and provides an account of valuable resources or toxic substances flowing through a process or region based on mass balance and mass conservation principles [1]. e!Sankey<sup>®</sup> software was used to draw the material flow diagram. Water Footprint analysis was conducted based on methodology developed by the Water Footprint Network [2]. Here, only irrigated water (blue) is included in the analysis. Green water is assumed to be a function of land use and is excluded from the footprint. Only freshwater use is being analyzed; so grey water is also excluded from the calculations. Data were collected from interviewing the plant manager and engineers from two starch plants in the same region in Thailand, one using the conventional system and another that recycles water from the separation process and hydro cyclone back to rasping process to recover starch. The calculation is based on 100 ton cassava input for both factories.

#### 4. Results

In the first starch plant in Figure 1, without water recycle, cassava with 27% moisture content is used as raw material. Starch production required a large amount of water and produced a lot of by-products and waste. As visualized in the sankey diagram, from every 100 ton of cassava, only 23 ton of starch was extracted; this involves use of almost 600 ton water and generated 600 ton of wastewater and almost 30 ton of residue to be managed. Moreover, a large amount of thermal energy was required to dry the wet starch. Fortunately, wastewater (effluent) was used to produce biogas which was in turn used to produce enough hot air and electricity for the factory. However, after producing biogas, the effluent still needs to be contained and evaporated out because of high COD content. Cassava pulp can be sold as feed but at low cost. Therefore, more sustainable technologies to reduce water, energy use and mass loss are still required. The water footprint flow of starch from the starch plant (without water recycle) is shown in Figure 2. Most of the water footprint was from cultivation of cassava which includes irrigated water and water footprint of fertilizers and pesticides. The water footprint from the factory contributed very little to the overall water footprint of starch which worked out to 470 m<sup>3</sup>/ton starch.

In the second starch plant in Figure 3, with water recycle, the effluent from the extraction and separation processes and from dewatering and drying processes was returned back to the washing and rasping processes and almost 2 ton of mass loss was recovered. Here, the productivity increase from 23 ton to 25 ton of starch and fresh water was reduced from 600 ton to 350 ton compared to the first plant. The water footprint flow of starch from the starch plant (with water recycle) is shown in Figure 4. The water footprint from the factory can be reduced by almost 50%. However, water footprint from the factory contributed very little to the overall water footprint of starch which is finally 432 m<sup>3</sup>/ton starch.

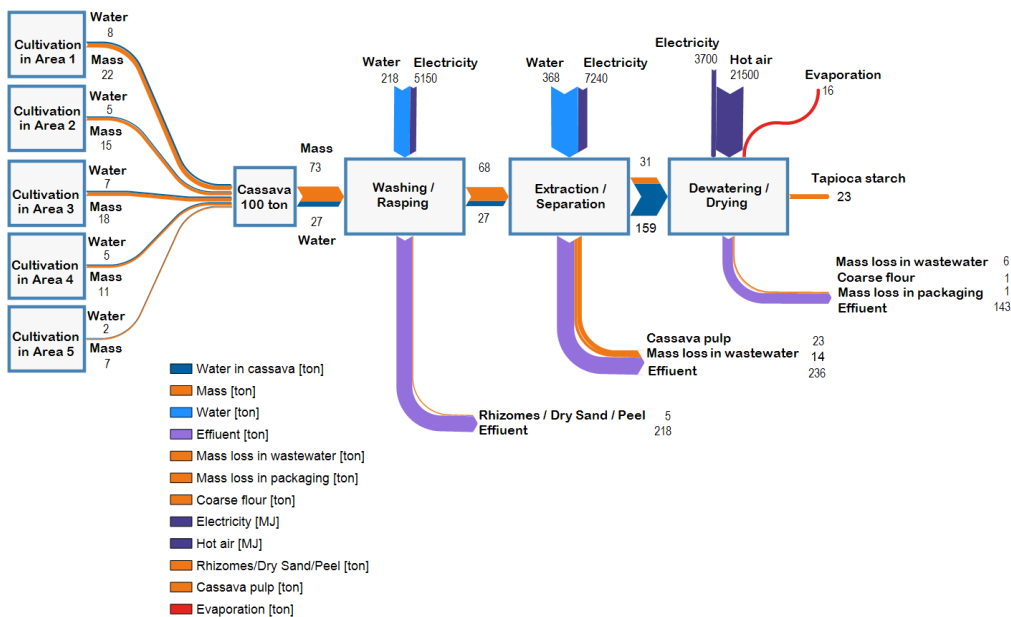

Figure 1: Material flow in the starch plant without water recycle

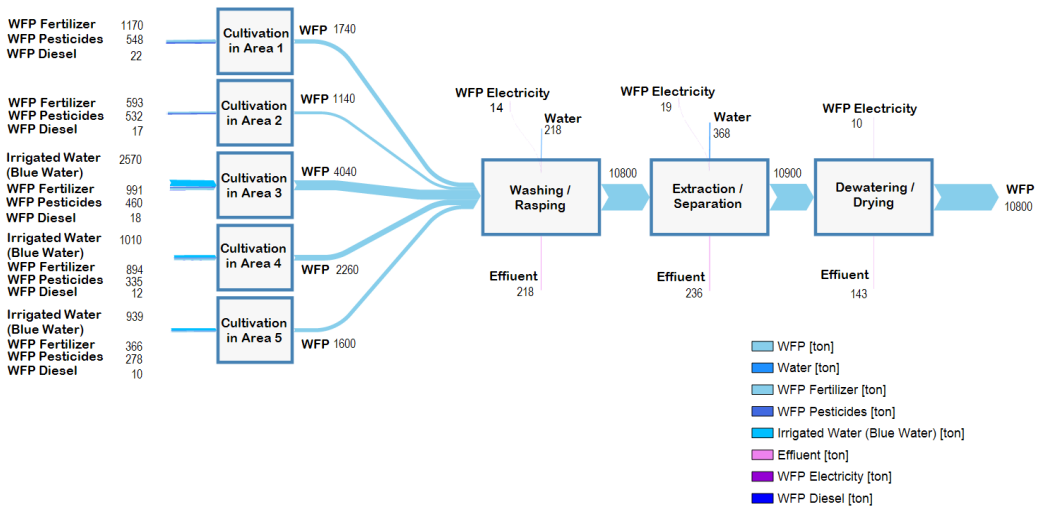

Figure 2: Water footprint (WFP) flow of starch in the starch plant without water recycle

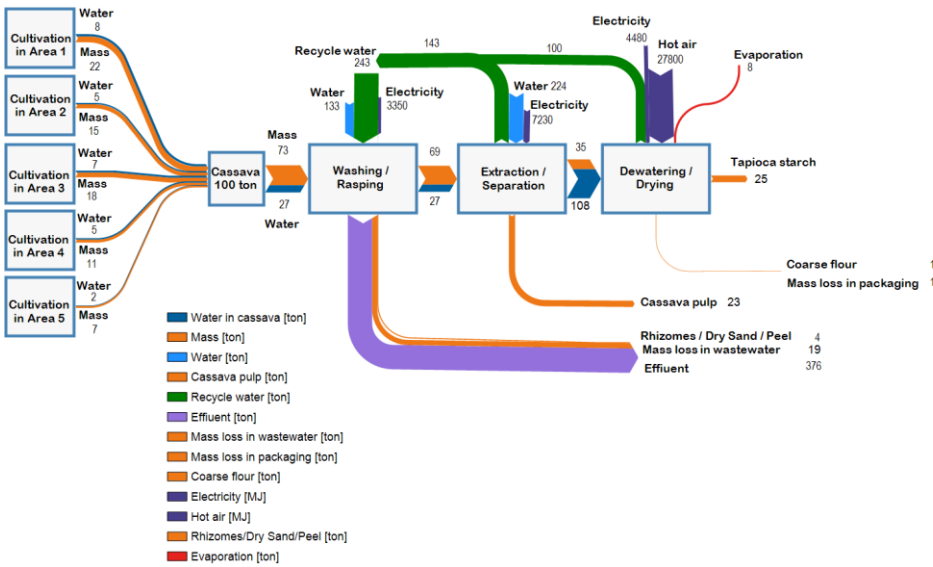

Figure 3: Material flow in the starch plant with water recycle

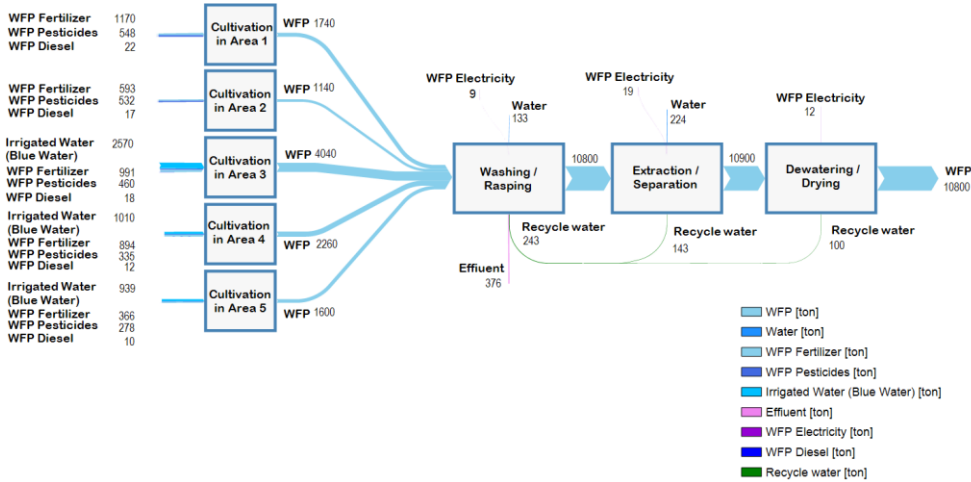

Figure 4: Water footprint flow of starch in the starch plant with water recycle

## **5. Conclusion**

The results show that the plant with water recycling can reduce loss and increase productivity as compared to the conventional one and can reduce water use in the processing step. However, the water footprint of starch can be reduced only by a small amount because the main water footprint contribution is from the cassava cultivation phase.

## **7. References**

- [1] Brunner, P. H.; Rechberger, H., 'Practical Handbook of Material Flow Analysis', (CRC Press LLC, Boca Raton, Florida, 2004)
- [2] Hoekstra, A.Y., Chapagain, A.K., Aldaya, M.M. and Mekonnen, M.M., 'The water footprint assessment manual: Setting the global standard' (Earthscan, London, UK., 2011)



# **Traditional cultivars, improved performance: reflections on the climate change intensity of traditional foods**

*Alessandro K. Cerutti<sup>1,2</sup>, Dario Donno<sup>1</sup>, Gabriella Mellano<sup>1</sup> and Gabriele L. Beccaro<sup>1</sup>*

*<sup>1</sup>Department of Agriculture, Forestry and Food Science, University of Torino,  
Largo Braccini 2, 10095 Grugliasco (TO), Italy*

*<sup>2</sup>Interdisciplinary Research Institute of Sustainability, University of Torino,  
Via Accademia Albertina 13, 10125 Torino (TO), Italy*

*E-mail contact: alessandro.cerutti@unito.it*

## **1. Abstract**

*Although there are statistics about the decline in the use of traditional cultivars, several researchers are supporting the idea that these varieties will continue to play an important role for many crops in a wide variety of production systems in the future because of their adaptation to marginal and low-input agriculture. Furthermore farmers around the world are still using traditional varieties to help coping with climate change. However, few studies have made specific environmental evaluations of traditional crop varieties in comparison with their modern relatives. Starting from literature case studies, some remarks on the application of the LCA approach to traditional crop varieties are drawn.*

## **2. Introduction**

Interest in traditional crop varieties has been growing over recent years in many areas of the world and many research programmes have been carried out to preserve germplasm with valuable quality features [1]. As traditional crop varieties are usually grown in the area they have been selected, they can be also considered as a product strongly bounded to a specific territory, reflecting the agricultural tradition of the region and the cultural identity of its inhabitants. Since traditional crop varieties are more adapted to the pedoclimatic characteristics of the region in which their traits were selected, they usually require fewer treatments and field operations per hectare of cultivation in comparison with introduced varieties. As a consequence, the agronomic requirements of each crop might be different from variety to variety and the different agronomic requirements might affect sensibly the plantation strategy and the field management, resulting in different environmental burdens. In particular, traditional cultivars are bound with the area that they were grown during centuries of agricultural adaptation to the pedoclimatic conditions, resulting in lower agricultural needs (especially fertilizers and pesticides) compared to introduced cultivars [2]. A low input agriculture, theoretically, leads to low environmental impact, nevertheless, the evaluation of the environmental performance of such kind of agricultural systems is not straightforward because of the choice of impact calculation settings such as the impact categories [3] and the functional unit [4][5].

The aim of the paper is to discuss strengths and potential pitfalls in the use of life cycle assessment (LCA) for the comparison of traditional and modern cultivars. In particular, a literature review is carried out conducted in order to point out representative case studies and methodological issues for LCA application for such agricultural productions.

### 3. Case studies from the literature review

Several papers investigate the role of traditional cultivars for the sustainable developing of rural communities [1], but just two papers applied life cycle assessment (LCA) to investigate traditional cultivars [6][7].

In [6], *Kolovi* and *Adramitiani*, two traditional olive varieties in Lesvos Island (Greece) are investigated thorough LCA in order to determine the differences in energy flow (renewable and non-renewable) and climate change potential among the two varieties and their farming systems (conventional and organic). In particular, the functional unit was the olive yield per hectare, therefore a mass-based unit which, in practical terms, corresponds to the impact of 1 ha of field. The system boundaries included the soil preparation before the installation of the olive grove, the production and the distribution of agricultural inputs (fertilizers and pesticides), production and use of machinery and the removal of the olive grove. The study clearly shows that farming practices with lower climate impacts are the ones that use more renewable energy inputs, regardless the variety and the agricultural practice. Unfortunately, in the study, a comparison with imported cultivars is not present, therefore it is not possible to verify differences in the environmental performance.

In [7] the environmental performance of three ancient apple cultivars from Torino and Cuneo provinces, namely *Grigia di Torriana*, *Magnana* and *Runsé*, has been calculated using LCA. In particular the environmental impact potentials (in six impact categories) of the cultivars were compared to those of the commercial cultivar Golden Delicious. The study was performed with the cradle-to-gate approach, gathering data regarding orchard structure, agricultural inputs, resource consumption and orchard management practices directly from the growers. In order to consider minor geographical differences, the life cycle inventory for each cultivar included the average of three orchards of each cultivar, spread throughout the two provinces. Three functional units were considered: the mass-based functional unit (1 t of fruit), a land-based (1 ha of orchard) and a currency-based (1000 € earned). Results of the assessment have similar trends in all the six impact categories, therefore here just results on climate change potential are presented (Table 1).

Functional unit	Dimension considered	Cultivars			
		Golden Delicious	Grigia T.	Magnana	Runsè
<i>Mass-based</i>	kg CO <sub>2</sub> -eq / t of fruit	163.9	203.9	192.9	196.5
<i>Land-based</i>	kg CO <sub>2</sub> -eq / ha of orchard	6555.3	5554.8	4775.9	4540.8
<i>Economic-value based</i>	kg CO <sub>2</sub> -eq / 1000€ earned	327.8	305.2	293.9	291.1

Table 1: Global warming potential of the four cultivars according to the three functional units considered in the study (elaboration from: Cerutti et al., 2013)

Considering impacts for 1 t product, the Golden Delicious cultivar showed the lowest global warming potential: in particular, the ancient cultivars showed on average 17% higher climate change impact in relation to Golden Delicious. However, the results were the opposite considering the impacts for 1 ha and 1000 € income. According to these functional units, the ancient cultivars had the lowest global warming potential and the impacts for Golden Delicious production per ha of orchard were on average 24% higher in global warming potential in relation to the ancient cultivars. A smaller difference can be found applying the Economic-value based functional unit; in this case ancient cultivars were on average 9% lower climate change impact in relation to Golden Delicious.

#### **4. The environmental performance as a methodological issue**

As highlighted in several studies [4][8], the choice of the functional unit might have a dramatic effect on the evaluation of the environmental performance. For fruit products, typical functional units are 1 kg of fresh fruit packed and delivered to the customer or 1 tonne of fruit at the farm gate [3]. Nevertheless the use of different functional units is reported to lead to a more complete understanding of the environmental impacts of a system under study [9]. A land-based functional unit, e.g. 1 ha of orchard, is not frequently used in LCA, partly because land use is not directly a service and does not provide a productive function, but it could give interesting results on the land use efficiency and intensification of a farm. In general, the land-based functional unit in fruit production is complementary to the mass-based functional unit and both should be used. Indeed, when considering only impacts per unit area, low input/output systems will have a better ranking in terms of decreased impacts at a regional level, but may create a need for more land use elsewhere, giving rise to additional impacts [5].

In [7] the results confirmed the better environmental performance of modern agricultural cultivars, in this case recent apple germplasm compared with ancient cultivars. In the pedoclimatic conditions of the Piemonte region of Northern Italy, Golden Delicious produced higher fruit yields than ancient cultivars per quantity of inputs. However, in terms of environmental sustainability, the ancient cultivars represented lower impacts per unit of cultivated land. Thus according to a “strong sustainability” framework, in which producing food while maintaining ecosystem services is more important than just production itself, traditional cultivars can be considered more environmentally sustainable than modern cultivars.

#### **5. Conclusions**

As the environmental performance of traditional cultivars depends on some methodological and site-dependent factors, it is not straightforward to determine what kind of cultivar should be grown in a specific case study in order to increase the environmental sustainability of production. When comparing traditional and modern varieties for environmental performance, several methodological issues have to be considered; in first place the choice to which functional unit, but also the system boundaries, the impact assessment methods and other parameters [3]. However, as a general remark, the results obtained from an environmental sustainability assessment may be integrated with other parameters, such as food quality, adaptiveness, effects on landscape properties and preservation of local heritage, in systematic assessments of different cultivars.

## 6. References

- [1] Jarvis, D.I., Hodgkin, T., Sthapit, B.R., Fadda, C. and Lopez-Noriega, I.. 'An heuristic framework for identifying multiple ways of supporting the conservation and use of traditional crop varieties within the agricultural production system.' *Critical reviews in plant sciences*. 30 (2011) 125-176.
- [2] Bisht, I. S., Mehta, P. S., and Bhandari, D. C.. 'Traditional crop diversity and its conservation on-farm for sustainable agricultural production in Kumaon Himalaya of Uttaranchal state: A case study.' *Genet. Resour. Crop Ev.* 54 (2007) 345–357.
- [3] Notarnicola, B., Salomone, R., Petti, L., Renzulli, P.A., Roma, R. and Cerutti, A.K.. 'Life Cycle Case Studies, Methodological Issues and Best Practices: Assessment in the Agri-food Sector'. (Springer International Publishing, 2015).
- [4] van der Werf, H. M. and Salou, T., 'Economic value as a functional unit for environmental labelling of food and other consumer products'. *Journal of Cleaner Production*, 94 (2015) 394-397.
- [5] Hayashi, K., 'Practical recommendations for supporting agricultural decisions through life cycle assessment based on two alternative views of crop production: the example of organic conversion.' *The International Journal of Life Cycle Assessment*, 18 (2013), 331-339.
- [6] Taxidis, E. T., Menexes, G. C., Mamolos, A. P., Tsatsarelis, C. A., Anagnostopoulos, C. D. and Kalburtji, K. L., 'Comparing organic and conventional olive groves relative to energy use and greenhouse gas emissions associated with the cultivation of two varieties.' *Applied Energy*, 149 (2015) 117-124.
- [7] Cerutti, A. K., Bruun, S., Donno, D., Beccaro, G. L. and Bounous, G., 'Environmental sustainability of traditional foods: the case of ancient apple cultivars in Northern Italy assessed by multifunctional LCA.' *Journal of Cleaner Production*, 52 (2013) 245-252.
- [8] Masset, G., Vieux, F. and Darmon, N., 'Which functional unit to identify sustainable foods?' *Public health nutrition*, (2015) 1-10.
- [9] Martínez-Blanco, J., Antón, A., Rieradevall, J., Castellari, M. and Muñoz, P., 'Comparing nutritional value and yield as functional units in the environmental assessment of horticultural production with organic or mineral fertilization.' *The Int. Journal of Life Cycle Assessment*, 16 (2010) 12-26.

# Social LCA: a framework for social impacts assessment in Italian wine sector

Authors: *Gabriella Arcese*<sup>1</sup>, *Maria Claudia Lucchetti*<sup>1</sup>, *Ilaria Massa*<sup>2</sup>

<sup>1</sup>University of Roma Tre, Via Silvio D'Amico 77, 00145 Rome

<sup>2</sup>Sapienza University of Rome, Via del Castro Laurenziano 9, 00161 Rome

E-mail contact: [gabriella.arcese@uniroma3.it](mailto:gabriella.arcese@uniroma3.it)

## 1. Abstract

*Wine sector performs economic functions as well as social and environmental functions. Recently, Social Life Cycle Assessment (S-LCA) methodology was developed in order to assess real or potential social impacts produced in different life cycle stages. This work proposes a set of indicators to assess social impacts produced by the Italian wine sector scenario, considering the stakeholder categories identified by UNEP/SETAC (2009). Stakeholder categories and subcategories of impacts are identified and classified according to the Methodological Sheets Scheme produced by UNEP/SETAC (2013).*

## 2. Introduction

Wine sector is a strategic sector for European Union (EU). In EU is located the 44,99% of the total world area under wines [1]. Italy is the second country in the world for wine production. The 96,62% of Italian vineyards area is used to cultivate wine grapes [2]. In 2014 Italy produced 44,739 mhl of wine [1] and Italian firms operating in the sector produced revenues for 6,1 billion of euro in 2013 [3]. As several sectors in agri-food industry, also wine sector generates multifunctional activities. In addition, to economic functions as goods and services production, wine sector carries out social and environmental functions. Moreover, Italian environment presents peculiarities which have specific socio-economic impacts such as the prevalence of family related employment in the agricultural stage [4], the creation of new occupations and training occasions linked to wine sector, the worrying rise of alcohol consumption among young people (under the age of legal drinking age) [5]. The relevance at national level of wine sector requires the assessment of socio-economic aspects to evaluate the overall sustainability level of the sector [6-7]. Social Life Cycle Assessment (S-LCA) methodology allows to assess real or potential socio-economic impacts along product/service life cycle stages.

## 3. Purpose and Methods

Following the instructions of S-LCA reference documents [8-9], the present research aims to identify socio-economic impact categories, subcategories and inventory indicators (Type I) in order to provide a model to set up the data inventory necessary to apply S-LCA to Italian wine sector. The functional unit considered is the wine contained in a 75cl glass bottle. The analysed system consists in four main life cycle stages, and for each one primary and support activities have been specified. The analysis approach used is *cradle to grave*. The main life cycle stages are : viticulture stage; transformation stage; marketing and selling stage; consumption stage. Due to wine sector multifunctionality and to the complexity of its supply chain in terms of exports, cut-off criteria are established. In order to simplify the system, activities related to exports of products, consumption in extra-national territory and activities not strictly related to wine production (such as touristic services as wine routes) have not been assess.

The study refers to the five main stakeholder categories proposed by Guidelines that have been detailed in accordance with specific industrial reports and scientific studies. In each life cycle stage, involved stakeholders and the relative impact categories and subcategories have been indicated. Impact subcategories which are not relevant in the analysed context were not accounted for. Instead, authors decided to include in the model impact subcategories created in previous case studies named *Area Reputation* [10] and *Professional Accomplishment* [11] (related to *Local Community* and *Workers* respectively), to highlight aspects relevant for wine sector framework. Revéret et al. (2015) define as *Professional Accomplishment* Workers' benefits perceived from "a stimulating rewarding workplace that allows personal and professional development". De Luca et al. (2015) assessed social life cycle of citrus farming in southern of Italy. They considered the influence of the analysed production on Local Community in terms of "contribution to reputation of the area they belong, in terms of quality of products and working conditions". *Area reputation* subcategory was used to evaluate the effects on local development due to the role that territory plays in qualifying products. Concerning the impacts on *Area Reputation* caused by working conditions, we not assessed them using this subcategory.

De Luca et al. (2015) consider *illegal work* and the *risk immigrants mistreatment* as the social impacts of the of working conditions in *Area Reputation* subcategory . We consider appropriate to assess the effects of these aspects on Local Community in the subcategory 'Safe and Healthy Living Conditions' in terms of verifying if workers have access to adequate health services and security systems provided at local level.

Lastly, inventory indicators were proposed according to the path designed in the UNEP/SETAC Methodological Sheets.

#### **4. Results and discussion**

Stakeholder categories have been detailed based on sector data:

- Workers: the category is composed by full-time workers, fixed-term workers, seasonal workers (employed on a farm for a temporary period), family related workers (full-time workers with family relationship up to the third degree).
- Local community: the category is defined according to the life cycle stage. The viticulture stage involves the population of Municipalities where vineyards are settled. The transformation stage involves the population of Municipalities where the facilities for producing, bottling and storage the wine are settled. The marketing and selling stage involves the population of Municipalities with which the product has a strong link (established through specific parameters such as local economic development, certification of product origin certificate etc.);
- Value chain actors: the category refers to inputs and services suppliers. In particular, in the marketing and selling stage it refers to wholesalers, Large Scale Retailers, wine bars [3];
- Consumers: End-users of wine;
- Society: the category covers organizations that from micro level (local authorities) to macro level (national bodies, associations) directly or indirectly interact with the analysed system.

Activity	Stakeholders categories	Impact subcategory	Inventory indicator description
Orders Management	Workers	Working conditions	Fulfillment of agreed contracts [12] Work-life balance: benefits from flexible working arrangements to balance work and private life
		Professional accomplishment	Distribution of responsibilities among family related workers Willingness to continue working in the same company or sector[12] Willingness to be trained regarding the work activities [12] Training courses [11-13]
		Fair salary	Regular payment [12-13] Minimum income according to law [12-13] Premium rate to compensate overtime working
		Equal opportunities	Educational level of family related workers Unequal treatments [10-13-14]
		Health and safety	Work accidents, complaints for injuries [12-10] Occupational diseases [12-10] Appropriate working equipment [12] Training programs for workers regarding occupational health and safety[12]
		Social benefit	Social benefits provided by law or by sectoral agreements [15]
	Society	Contribution to economic development	Estimated employment impact [16] Estimated contribution to national economy: Export trade; Tax incentive [15]; Fiscal contributions / Taxes [15]
Marketing & Selling	Consumers	Transparency	Well-defined and clear information [13] Availability of information about the company and suppliers [9]
	Local Community	Area Reputation	Wine quality certification [10] Presence of quality certificates of origin for local products
	Value chain actors	Suppliers relations	Payment on time [9] Training courses for retailers

*Table 1: Impact subcategories and Inventory indicators description per Stakeholder category by corresponding support activity for the stage "marketing and selling"*

Table 1 presents details related to one of the analysed life cycle stages, specifically Marketing and Selling stage. For each activity there, we identified the involved stakeholders, their impact subcategories and we provided description of inventory indicators specifying their references. In Marketing and Selling support activities we included also 'Workers' and 'Society' stakeholder categories presenting the same impact subcategories and impact indicators that were defined for the 'Orders Management' activities (which consist in orders intake, lots preparation and lots consignment).

## 5. Conclusion and Future Outlook

This work presents the initial results of an ongoing research that aims to implement a basic framework for applying S-LCA to the Italian wine sector. The next step to consolidate the model will be to check if the inventory indicators extrapolated from literature correspond with those chosen by stakeholders. The study highlights that further research is necessary to implement S-LCA methodology in order to improve its application in agri-food sector.

For example, in agri-food sector, raw materials origin is of particular importance more than other sectors. We suggest to develop and integrate *Area Reputation* as an impact subcategory to evaluate social impacts for Local Community.

## 6. References

- [1] OIV, 'State of Vitiviniculture World Market', Available online [http://www.oiv.int/oiv/files/0%20-%20Actualites/EN/OIV\\_Note\\_Conj\\_2014\\_%20EN.pdf](http://www.oiv.int/oiv/files/0%20-%20Actualites/EN/OIV_Note_Conj_2014_%20EN.pdf)
- [2] ISTAT, '6th Agriculture Census – Atlas of Italian Agriculture', Edited by Bellini, G., Lipizzi, F., Cosentino, F. and Giordano, P., ISBN: 978-88-458-1781-6
- [3] Mediobanca, 'Indagine sul Settore Vinicolo', (March 2015), Available online [www.mbres.it](http://www.mbres.it), ISSN 1825-6104
- [4] ISTAT, '6th Agriculture Census – Characteristics of Agricultural Farms', Edited by De Gaetano, L., ISBN:978-88-458-1800-4
- [5] ISTAT, 'Uso e Abuso di Alcol in Italia', (April 2014), Available on line <http://www.istat.it/it/archivio/88167>
- [6] Tamburini, E., Pedrini, P., Marchetti, M. G., Fano, E. A. and Castaldelli, G., 'Life Cycle Based Evaluation of Environmental and Economic Impacts of Agricultural Productions in the Mediterranean Area', *Sust.* 7(3) (2015) 2915-2935.
- [7] Dreyer, L., Hauschild, M. and Schierbeck, J., 'A framework for social life cycle impact assessment', *Int. J. Life Cycle Assess.* 11(2) (2006) 88–97.
- [8] UNEP/SETAC, 'Guidelines for social life cycle assessment of products', UNEP/SETAC Life Cycle Initiative, Paris, (2009)
- [9] UNEP/SETAC, 'Methodological sheets of sub-categories of impact for a Social LCA', (2010) Available online <http://lcinitiative.unep.fr>.
- [10] De Luca, A. I., Iofrida, N., Strano, A., Falcone, G. and Gulisano, G., 'Social life cycle assessment and participatory approaches: A methodological proposal applied to citrus farming in Southern Italy', In: *Integrated Environmental Assessment and Management*, Edited by Richard J. Wenning, Wiley Online Library, (2015)
- [11] Revéret, J.P., Couture, J. and Parent, J., 'Socioeconomic LCA of Milk Production in Canada', In: *Social Life Cycle Assessment*, Springer Singapore, (2015) 25-69.
- [12] Aparcana, S. and Salhofer, S., 'Application of a methodology for the social life cycle assessment of recycling systems in low-income countries: three Peruvian case studies', *Int. J. Life Cycle Assess.* 18(5) (2013) 1116-1128.
- [13] Jørgensen, A., Le Bocq, A., Nazarkina, L., and Hauschild, M., 'Methodologies for social life cycle assessment', *Int. J. Life Cycle Assess.* 13(2) (2008) 96-103
- [14] Ekener-Petersen, E. and Finnveden, G., 'Potential hotspots identified by social LCA—part 1: a case study of a laptop computer', *Int. J. Life Cycle Assess.* 18(1) (2013) 127-143.
- [15] Bork, C.A.S., Junior, D.J.D.B. and de Oliveira Gomes, J., 'Social Life Cycle Assessment of three Companies of the Furniture Sector', *Proceedings of the 22nd CIRP conference on Life Cycle Engineering, Procedia CIRP* 29 (2015) 150-155.
- [16] Foolmaun, R.K. and Ramjeeawon, T., 'Comparative life cycle assessment and social life cycle assessment of used polyethylene terephthalate (PET) bottles in Mauritius', *Int. J. Life Cycle Assess.*, 18(1) (2013) 155-171.



# Social Life Cycle Assessment in the honey industry

Author(s): (M. D'Eusanio<sup>1</sup>, M. Serreli<sup>2</sup>, L.Petti<sup>1</sup>)

<sup>1</sup>Dipartimento di Economia, Università "G. d'Annunzio" Pescara – Italy

<sup>2</sup>serrelimonica@gmail.com

E-mail contact: l.petti@unich.it

## 1. Abstract

*The goal of this paper is to assess and present the social aspects of the supply chain of honey through the Social Life Cycle Assessment (SLCA). Honey, and all its beekeeping products, are the subjects of a thriving market; indeed, Italian beekeeping accounts for 1.1 million beehives and an estimated turnover of 70 million euros [1]. It is important to note the value of bee pollination for the conservation of natural plant biodiversity. Certainly, it has been estimated that about 35% of food consumption depends directly on the pollination of fruit and vegetable crops or indirectly on the pollination of cultivated fields to forage for livestock. The expected outcome is achieving greater awareness in terms of sustainability, reinforcing customer loyalty and strengthening interaction of the supply chain.*

## 2. Introduction

Honey is a highly concentrated water solution of two sugar types, dextrose glucose and levulose (fructose), which account for about 85% of the solids in honey. The importance of honey is associated not only to nutritional reasons (e.g., a high and immediate energy intake, presence of enzymes and amino acids that make it an excellent supplement) [2], but also to sustaining the natural cycle of plants. Bees are known to be sentinels of the ecosystem, allowing pollination and conservation of plant biodiversity; a reduction in their activity would have negative effects on both the entire environmental and industrial systems [1]. A sustainable agri-food system can reach a shared responsibility of the entire supply chain also by: - enhancing integrated resources in all its components, - considering the impacts of its products beyond its own sphere of local operation within a life cycle perspective and - assessing the existing vertical and horizontal linkages within the sub-sector as well as the functions and roles of actors from input supply to the market [4, 5]. The goal of this paper is to assess and present the social aspects of the supply chain of the honey produced by the Apicoltura Luca Finocchio enterprise, following the Social Life Cycle Assessment (SLCA) methodology. This case study is based on the "Guidelines for Social Life Cycle Assessment of Products" [6] and on the Subcategory Assessment Method (SAM) [7]. The ultimate goal is to provide a complete picture of the social impacts associated with honey along its life cycle: from input suppliers to consumers. The honey value chain analysis encompasses four phases: 1) the input suppliers, including the organisations producing hive equipment, beeswax, supplement feeding, queen bees and bees supply, honey collection and transport by the beekeeper; 2) honey processing; 3) honey primary packaging; 4) the wholesale or retail distribution.

## 3. Methodological Issues

The SLCA is based on the methodological framework of the E-LCA [8]. Social and socioeconomic performances assessed with SLCA directly affect positively or negatively the stakeholders of the enterprise [9] and influence its decisions for the improvement of the product life cycle. The method used for assessing the subcategories in this paper is SAM [7].

The object studied in this paper is the life-cycle of 500 gr of honey (equivalent to the sweetening power of 1 kg of sugar) in a jar in primary packaging. The case study assesses the performances at the level of all five stakeholders: workers, consumers, local communities, value chain actors and society. The system boundaries comprise the phases from gate to gate of the life cycle of the product; Figure 1 illustrates the different processes involved in the honey life cycle. The system boundaries are demonstrated with the dotted line. It was not possible in the framework of this study to analyse all background processes in detail. The system includes the following phases: 1) Honey production including only the hive equipment; 2) honey harvest; 3) honey processing; 4) packaging and 5) distribution. Some process units have not been included in the analysis because of the difficulties met whilst looking for primary data especially from the value chain actors. The second step was the data collection using field research, interviews and questionnaires, based on the Methodological Sheets for Sub-categories [6]. The evaluation of the subcategories of this study has been carried out using SAM.

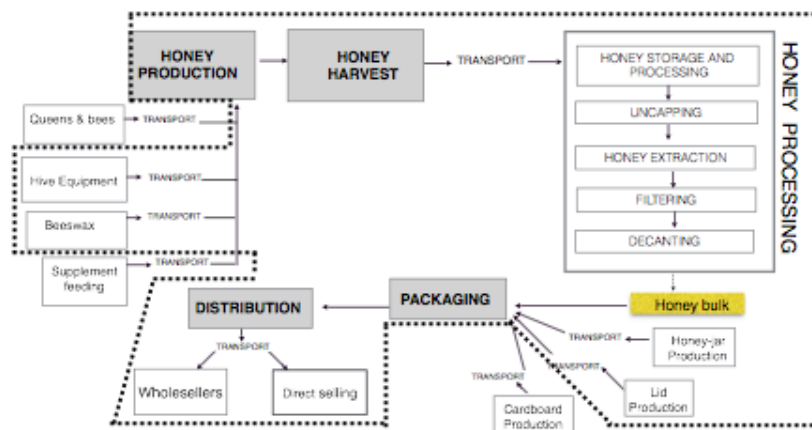

Figure 1: process flow of the honey and system boundaries

### 3.1 Discussion and results

The results of the assessment show an almost uniform behaviour of the organisations of honey supply chain with regard to some subcategories, such as:

**Working Hours** range between six to eight hours and they usually start from early in the morning. The agricultural work is characterised by flexible working hours and by nightlife displacements of bees in the different fields of flowers, in order to obtain various types and grades of honey;

**Freedom of association and collective bargaining**, the workers do not join a union out of their personal choice; also child labour is absent in this organisation, such as forced labour.

**Transparency**: the organisations, which monitor the transparency possess a website, but they produce no certificates nor sustainability reports for company conduct;

**End of life responsibility**: in this case study, the company does not provide accurate and complete information to consumers regarding appropriate end-of-life options. Consumers have suggested different options for the recycling of the product after it has been used, such as using honey-jar for décor, etc.

As far as the Local Community is concerned, honey is involved in the promotion of the cultural heritage through the implementation of educational programmes: today's children will be tomorrow's citizens that are aware of the important role of beekeeping.

The health and safety of consumers is protected by the organisation and this commitment is spread along the honey value chain.

The stakeholder society received a high score because the organisation is involved in projects of public engagement, which give the possibility to improve its sustainability, thanks to the awareness of the role played in biodiversity and environmental by beekeeping. Indeed the pollinators strongly influence ecological relationships, ecosystem conservation and stability, genetic variation in the plant community, floral diversity, specialisation and evolution society itself.

#### **4. Improvements and conclusions**

The organisation's website is an excellent showcase for consumer feedback, it also allows consumers to give voice to their opinions and complaints, enabling improvement on the whole. Furthermore, the organisation pays attention to consumers' health and safety, but there is room for improvement with regard to the end-of-life management and transparency. Moreover, this work has revealed a weakness among the honey value chain actors, showing a lack of collaboration with the producer. Unfortunately, the largest obstacle is cultural; the company does not get involved in helping in this type of analysis. Social responsibility of companies can be of benefit towards the rethinking of the business strategy, which brings its mission, vision and policy to better focus on the company [10]. For example, the company could apply a sustainability policy and implement the sale of unpackaged honey (to save in plastic), to safeguard the environment and ensure a good final price. The CSR leads to the strengthening of corporate reputation through a commitment to social and environmental aspects [10] thus obtaining a collective agreement. "The ultimate goal of an S-LCA technique is to promote the improvement of social conditions throughout the life cycle of a product, where human well-being" [6, p.16] is a central concept that needs to be defined and articulated. Beekeeping has a positive effect on the ecosystem in which it operates; those who play a role in beekeeping perform a service for the territory and contribute to the improvement of the environment. On basis of the FAO [3] data, the bee pollination not only has results for fruits, berries or seeds, but it may also give a better quality of produce, and the efficient pollination of flowers may also serve to protect the crops against pests. Bees are a natural resource, freely available in the wild, and beekeeping ensures the continuation of natural assets. As bees visit flowers, they are not only collecting food for today, but by their pollinator activities, they are ensuring future generations of food plants, available for future generations of bees, and for us too. Flowering plants and their associated bees are interdependent: you cannot have one without the other. With regard to the definition of a livelihood, it is clear that beekeeping actually helps to sustain the natural resource base. In this perspective researching, communicating and promoting this kind of products is something fundamental.

#### **5. Acknowledgements**

The authors would like to thank the company "Apicoltura Luca Finocchio (Abruzzo)" for their kind cooperation and Dr. Ioannis Arzoumanidis for his contribution to reviewing this paper.

## 6. References

- [1] Coldiretti, 'Dimezzato il miele, è allarme furti', Il giornale delle imprese agroalimentari, 15 Aprile 2015.
- [2] White. J.W. Jr., 'Detection of Honey Adulteration by Carbohydrate', JAOAC. 63 (1)(1980) 11-18.
- [3] Brandbear N., 'Bees ad their role in forest livelihoods', Non-wood forest products, 19 (2009) 13-16.
- [4] Benoît-Norris, C., Cavan, D., and Norris, G., 'Identifying social impacts in product supply chains: overview and application of the Social Hotspot Database', Sustainability 4 (9)(2012) 1946-1965.
- [5] Trust, K., 'The Nature and Markets of Honey Value Chains in Uganda', DIMAT, 2012, 22-24.
- [6] Benoît, C., Mazijn, B., 'Guidelines for social life cycle assessment of products', Unep/Setac, Life Cycle Initiative, 2009, Belgium.
- [7] Sanchez Ramirez, P.K., Petti, L., Haberland, N.T., and Ugaya C.M.L., 'Subcategory assessment method for social life cycle assessment. Part 1: methodological framework', International Journal Life Cycle Assess, 19 (2014) 1515–1523.
- [8] ISO 14044:2006. Environmental Management, Life Cycle Assessment, Requirements and Guidelines. International Organization of Standardization, 2006.
- [9] Hosseinijou, S.A., Saeed, M., and Shirazi, M.A., 'Social life cycle assessment for material selection: a case study of building materials', International Journal Life Cycle Assess, 19 (2014) 620–645.
- [10] Molteni M., 'Responsabilità sociale e performance d'impresa. Per una sintesi socio-competitiva', Vita e Pensiero, 2004. List and number all bibliographical references at the end of the paper under the major heading

## **Environmental and social impact indicators of soil consumption**

*Monica Lavagna<sup>1</sup>; Vito D'Incognito<sup>2</sup>; Alberto Prinzo<sup>1</sup>; Sara Ganassali<sup>1</sup>*

*1Politecnico di Milano, Dip. ABC, via Bonardi 9, 20133 Milano*

*2Take Care International, via Vallazze 95, 20131 Milano*

*E-mail contact: [monica.lavagna@polimi.it](mailto:monica.lavagna@polimi.it); [vdincognito@take-care.it](mailto:vdincognito@take-care.it)*

### **1. Abstract**

*This research is aimed to evaluating the impacts associated to the change of land use from agricultural and forest soils to artificial soils and estimating the losses of soil functions within the Lombardy region. Due to the available data sources, 5 years representative of different historical periods (1926, 1955, 1980, 1999 e 2007) have been examined, but due to the different scopes of the sources only the territory of Bergamo, Brescia and Cremona provinces where chosen for the completeness of data. As it is evident, each increase of the artificial soil reduces the agricultural soil, and it produces negative effects on the functionality of the soil. The effects considered in the paper are crops production losses and anthropic emissions increase; they are expressed by means of a set of indicators like CO<sub>2</sub> sequestration losses, potential agricultural production depletion, evapotranspired water decrease and emission of energy/heat in the atmosphere.*

### **2. Introduction**

The scope of the paper is to analyse the environmental and social consequences of the land consumption. The paper is based on the analysis of the available data of the land (or soil) functions and distributions over the time; the data were examined with the target to identify the agricultural, forest and artificial soils evolution. Due to the available data sources, the soil analysis was applied to an historical period of about 80 years (1926[1], 1955[2], 1980[3], 1999[4] e 2007[5]). Of course, due to the different origins and scopes of the books, not all the data are comparable and only the territory having the full set of required data were used, as it is the case for Bergamo, Brescia and Cremona provinces of the Lombardy Region. The data evolution could be summarized as an urbanization trend of growth and a rapid decrease of natural areas, which, in some way, could be extended to other provinces of the Lombardy and also to other Regions. In this research, the soil consumption has been connected to a growing environmental inefficiency, which may be represented by means of the following impacts: crops production losses and anthropic emissions increase, that could be represented by means of a set of indicators that express the agricultural production losses and the climatic regulation capacity losses with the consequent increase of the atmospheric temperature.

### **3. Analysis of soil cover data of Lombardy and environmental assessment**

The values of the surface (hectares = ha) of the three categories of land use (agricultural soil, forest soil and artificial soil) in the provinces of Bergamo, Brescia and Cremona in the period 1926-1955 show the prevalence of agricultural and forest areas; the urban areas are minority and limited to specific areas. The land data of 1926 [1] are complete only for the agricultural soil, but they are not sufficient for identifying the forest and artificial soils; the reason is the propaganda of the fascist period concerning the campaign of Italian wheat production. The successive timeframes show the growth of the urbanization processes, with the increase of the artificial surface (28,4% of Bergamo land area and 35% of Brescia land area) [6]. At the same time there is an important decrease of the agricultural land, more than 50% of the total land area.

As opposed to agricultural areas, the surface of the forest land and semi-natural areas, show an increase: +80,000 ha (from 504,000 in 1955 to 584,000 ha in 2007, according to DUSAF [4] data), against +195,000 ha of new urbanized areas (increased from 91,000 to 286,000 ha). This trend stems from the abandonment of the agricultural activity in the foothills area (with a shift of the land from agricultural to forest).

### 3.1 Indicators and environmental assessment

The land use change is an irreversible landscape transformation and its increase led to permanent agro-ecological losses. In order to estimate the environmental damage caused by the process of consumption and transformation of soils, several environmental and productive indicators [7] can be associated to the surfaces of the category of land use change:

- emission of CO<sub>2</sub> stocked in the soils: 20 kg CO<sub>2</sub>eq stock/m<sup>2</sup>;
- loss of the annual capacity of the soil to accumulate CO<sub>2</sub>: 5 kg CO<sub>2</sub>eq/y\*m<sup>2</sup>
- loss of evapotranspiration due to the waterproofing of natural soils 600 l/y\*m<sup>2</sup>;
- agricultural production depletion potential, wheat production losses 500g/y\*m<sup>2</sup>;
- manpower requirements in agricultural soils: 0,06 person/ha y [8]

increase of emission into the atmosphere of energy/heat: 17,50 kWh/y\*m<sup>2</sup>. The adopted indicators are known literature values used to measure and monitor soils functionality change.

In the following tables and diagrams are reported the results of the indicators application to the soil consumptions.

Agricultural soils						
		1926-27	1955	1980	1999	2005-2007
<b>Bergamo</b>	ha	173.485	115.360	106.681	82.429	77.976
<b>Brescia</b>	ha	292.548	220.984	209.187	180.206	167.315
<b>Cremona</b>	ha	155.257	161.429	164.989	153.768	151.370
<b>Amount</b>	<b>ha</b>	<b>621.290</b>	<b>497.773</b>	<b>561.857</b>	<b>416.403</b>	<b>396.661</b>

Table 1: Agricultural Soil comparing in five historical periods.

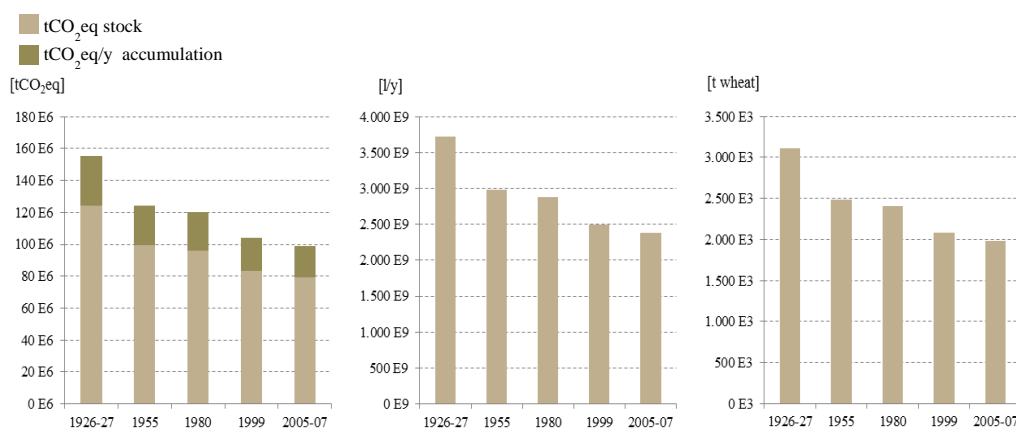

Figure 1: Environmental and productive indicators trend of Agricultural Soils

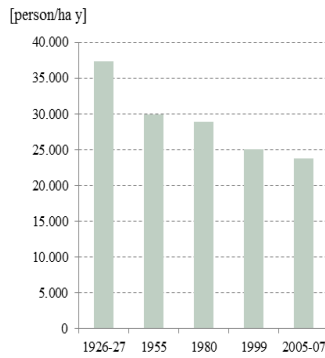

Figure 2: Manpower requirements in Agricultural Soils

		Forest soils			
		1955	1980	1999	2005-2007
<b>Bergamo</b>	ha	147.423	143.620	154.563	154.569
<b>Brescia</b>	ha	219.333	216.460	224.910	230.929
<b>Cremona</b>	ha	6.071	1.192	4.328	4.723
<b>Amount</b>	<b>ha</b>	<b>372.827</b>	<b>361.272</b>	<b>383.801</b>	<b>390.221</b>

Table 2: Comparison between surface area of Forest soils in four historical periods

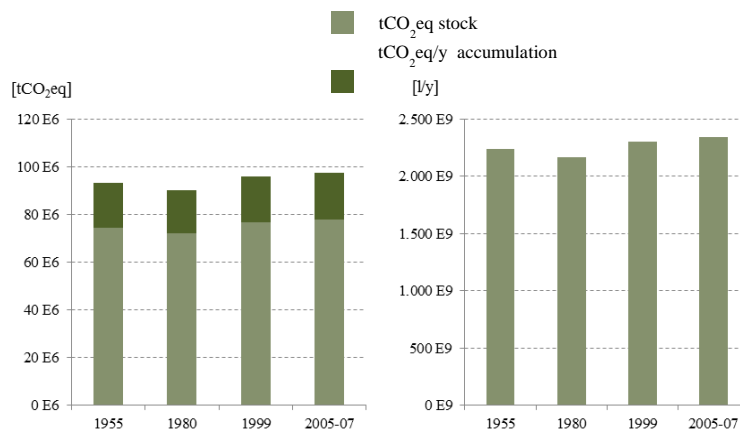

Figure 2: Environmental indicators trend of Forest Soils

		Artificial soils			
		1955	1980	1999	2005-2007
<b>Bergamo</b>	ha	8.297	21.268	33.887	38.274
<b>Brescia</b>	ha	12.850	28.074	47.273	53.996
<b>Cremona</b>	ha	6.894	9.163	16.524	18.694
<b>Amount</b>	<b>ha</b>	<b>28.041</b>	<b>58.505</b>	<b>97.683</b>	<b>110.964</b>

Table 3: Comparison between surface area of Artificial soils in four historical periods

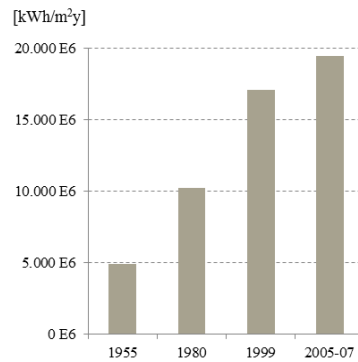

Figure 3: Environmental indicator trend of Artificial soils

The comparison between results obtained by the association of indicators to land use categories, shows as the cropland's progressive reduction leads to a loss of productive value, evapotranspiration ability and a loss of CO<sub>2</sub> soil storage. The loss of agricultural soil is higher in Bergamo and Brescia provinces, due to the highest industrialization. They are foothills territories and the availability of croplands is less if compared to Cremona province, that is situated in Po valley and bounded to agricultural activities. Forest areas increase, between 1980 and 2007, thanks to environmental policies development that incentivize the reforestation, the growth of trees for wood production (Reg. 2080/92) and the colonization of abandoned agricultural lands. With the increase of forest and natural areas, there is an increase of carbon soil stock, potential CO<sub>2</sub> storage ability and evapotranspiration of soils. In the timeframes analyzed the growing demand of settlement soil is feed by transformation processes in productive and service sectors, due to the location of logistic and commercial services. Added to this there is the demand of higher urban life quality, that promote urban sprawl and its pressure on the environment, with a consequent and permanent loss of agricultural resources (between 1955 and 1999). Artificial areas see an increase of atmospheric temperature (urban heat island) due to the growth of energy consumption and the lack of urban green areas. These problems are responsible of energy increase for cooling, of surface water temperature increase and of suspension into the atmosphere of greenhouse gas emissions (harmful to human health). We can confirm that the loss of croplands depends by the increase of other soil use categories: his value is the same to the sum of the increase of artificial areas and forest areas.

#### 4. Conclusion and discussion

The results show some trends of worsening of environmental and living conditions linked to soils artificialization. In some nations the issue of zero land consumption has become regulation, in order to promote the riqualification of brownfield sites. In Germany, since 15 years policies to control soil consumption are active in order to achieving the threshold of 30 ha/day within 2020 (from 129 ha/day and the new goal of zero soil consumption within 2050). In Italy it is estimated a daily soil use of 668 ha/day, that is not justified by the demographic growth value. Land consumption cause a reduction of the biocapacity available for every citizen and all population. In Italy, using the Global Footprint Network data (revised in 2008) [9], the ecological footprint is equal to 4,8 ha/pro capite againts a biocapacity of 1,2 ha/procapite. Therefore cropland reduction of some Lombardy provinces can be applied to the whole Italy and it identifies a soil reduction of 33%, from 1,05 to 0,7 ha/pro capite, in timeframes considered.



This situation does not concern only Italy but the whole western world and shows an additional problem: how to maintain or increase food production through intensification of land use with fertilizers or with the use of marginal soils. However they require a higher environmental burden and a higher economic commitment for equal production results [10]. Soil consumption has negative effects also on society: the share of people employed in agricultural sector, between 2000 and 2012, shows a decrease about 51% (from 2,26% to 1,36%). This value seems to be proportional to regional croplands reduction [11]. However, the increase of awareness about the effects of soil protection and market recovery have led to occupation growth of 1% in 2012, breaking the sharp contraction trend of agriculture employment. The low land preservation cause phenomena that incentivize natural and cultural heritage depletion. Landscape fragmentation is caused by urban sprawl expansion and soil sealing, that exercise a heavy pressure on water resources, ecosystem and biodiversity with an irreversible alteration of green spaces quality, a deterioration of life quality and a landscape degradation. This causes a damage to historical and cultural land value that has also a great economy importance (e.g. as source of tourism).

## 5. References

- [1] Sindacato Nazionali Tecnici Agricoli, Prima mostra nazionale del grano. I progressi della granicoltura italiana ', (Milano, 1928)
- [2] Banca dati Volo GAI regione Lombardia (1954)
- [3] Banca dati Volo TEM regione Lombardia (1980)
- [4] Banca dati DUSAF 1.1 regione Lombardia (1998-1999)
- [5] Banca dati DUSAF 2.0 regione Lombardia (2005-2007)
- [6] Osservatorio Nazionale sui Consumi di Suolo, 'Primo rapporto 2009', Maggioli editore, Santarcangelo di Romagna, 2009
- [7] Brenna S., 'L'uso del suolo in Lombardia negli ultimi 50 anni. Prime analisi sulle banche dati', ERSAF-ente regionale per i servizi all'agricoltura e alle foreste, Milano, 2011
- [8] Tabella Regionale dei valori di impiego di manodopera, Tabella ULA, Decreto n. 15339 del 6 Dicembre 2007
- [9] Ecological footprint and Biocapacity data" Global Footprint Network, 2008
- [10] Report from the EU Commission "on indirect land use change related to biofuels and bioliquids, Bruxelles 22.12.2010
- [11] VI Censimento generale dell'agricoltura, <http://censimentoagricoltura.istat.it/>

# Tools to improve the energy efficiency of the institutional food system

Authors: (Matteo Clementi<sup>1</sup>, Chiara Ducoli<sup>1</sup>, Gianni Scudo<sup>1</sup>, Paola Caputo<sup>2</sup>)

<sup>1</sup>Department of Architecture and Urban Studies, Politecnico di Milano, Milano

<sup>2</sup>Department of Architecture, Built Environment and Construction Engineering, Politecnico di Milano, Milano

E-mail contact: [matteo.clementi@polimi.it](mailto:matteo.clementi@polimi.it)

## 1. Abstract

*This research originates from a wide multi-disciplinary project aimed at developing a self-sufficient approach to improve the institutional food system in an area of Northern Italy. The aim of this research is to give some guidelines to implement ideal scenarios of food production, processing, consumption, and waste management at the local level. A methodology has been developed to analyze the main energy flows and matter related to this catering, and to outline possible optimal scenarios. This methodology also allows to analyze case studies and to suggest improvements in order to reduce their energy consumption exploring all the steps of the supply chain (considering the Life Cycle Assessment approach). The results for the current development level of the research allow the analysis and the development of improving scenarios of 20 supply chains among the main in the menus. The data in the database are mainly related to the production phase and transformation. Future investigation will cover more deeply the cooking phase and waste management.*

## 2. Introduction

The information here presented show some results of a work, which is part of a wider multidisciplinary project called “Bioregione” and funded by Fondazione Cariplo. The aim of this research is to suggest strategies to check the food self-sufficiency in the institutional food system of a “bioregion”, that could be defined as an area required to achieve the self-sufficiency in terms of food supply. In this specific case, the area includes Lombardia, a region of Northern Italy and the municipality of Novara (a town in Piemonte, the region bordering Lombardia to the west). The paper shows the actual level of development of a tool to verify and improve local self-sufficiency. To reach this goal, a database has been developed to bring together the bioregional food demand and the food local supply. The model presented in this research (the Food Chain Model - FCM) takes care of this issues.

## 3. Method

To outline optimum scenarios of production, processing, consumption, and waste management it has been necessary to streamline the food chains, retracing all the stages of the life cycle of the main food types, developing a database able to quantitatively describe the main steps of the food chains and to evaluate the environmental impacts of each step by the adopted impact indicators.

The use of quantitative indicators (Productive Land and Cumulative Energy Demand - CED) allows a comparison among the environmental impacts related to different scenarios. In this framework, our work package is devoted to the analysis and optimization of the main flows of matter and energy related to the several steps of the food chains of the institutional catering [1].

The Productive Land indicator is aimed at assessing the balance between local demand and supply and CED has been considered as the indicator that would lend transparency to the energy use profile in the supply chain in order to identify and choose effective improving options. The method of calculation adopted for this indicator (CED) refers to the assumptions set out in the supporting documentation for the database Ecoinvent [2].

The development of the FCM has been supported by specific databases and by data collected in the scientific literature. In particular, the analysis of the embodied energy in products used as agricultural treatments and nutrients refers to the Swiss data bank, Ecoinvent [3], as well as the analysis of the transportation phase. Field production storage and food processing refer to the database LCAfood [4] and to other scientific publications and reports about Environmental Product Declarations. LCAfood collects information related to Danish companies and local productions in the context of Northern Europe. The data has been updated about the on-field production, by adapting the yields and energy/material budgets with characteristic values of Northern Italy [5].

The methodology proposed in this research is divided into the following steps:

- Editing of the FCM database using scientific literature data, concerning the main foods and the related stages of the meal life cycle, including waste management.
- Integration of the collected data with practices adapted to the local agricultural yield and good practices in the field of production, consumption and waste management.
- Breakdown of each food chain at a level of resolution appropriate to the development of improving scenarios. In order to be able to identify the highest impact steps, and then the most effective choices to reduce the energy consumption and the related soil occupation (in particular when using renewable resources available locally).
- Compiling the FCM with data on the food demand (in kilograms or tons) of the case study.
- Quantifying the environmental impacts of the menu related to different periods of time, for instance the weekly menu (fig. 1) or the annual menu (fig. 3) [6] [7].
- Development of improving scenarios by replacing the generally accepted practices with good production practices related to the same kind of food, replacing it with foods of different kinds but with similar nutritional properties, reducing transport distances, etc..

#### **4. Results and conclusions**

The FCM model is currently tested on a territorial scale, carrying on the analysis of the supply chains, which constitute the main food scholastic needs in an area made up of a group of municipalities that occupies 26% of the area of the province of Milan [6]. It was previously tested on a weekly menu in some schools in the city of Milan [7]. Figure 1 shows some of the results relating to this application and refers to the amount of non-renewable primary energy (CED) used for production, transport and cooking of some of the main food of a weekly menu in three schools of Milan.

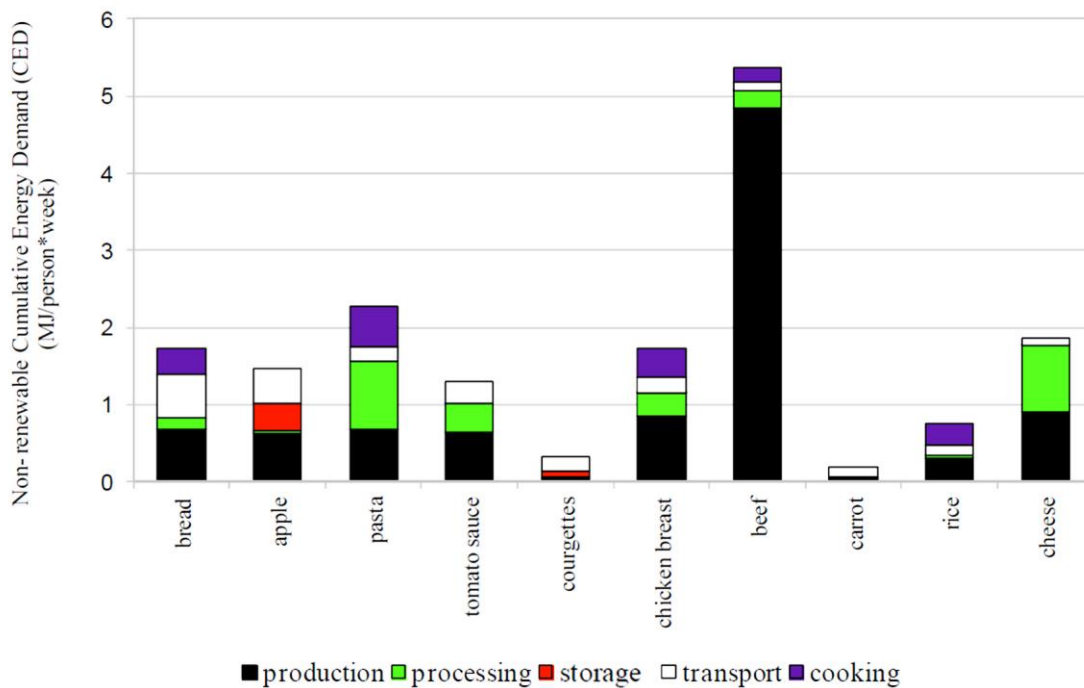

Figure 1: Non-renewable CED (Cumulative Energy Demand) of some foods on the menu of the case studies (one week consumption / person)

The current level of development of the FCM sees the complete definition of the methodological aspects, a comprehensive compilation of the database with scientific literature data and the detailed deepening of some of the main food chains representative of the local demand (20 foodchains), integrating data with practices adapted to the local agricultural yield.

The aggregated results in Figure 2 show the amount of the CED indicator applied to the analysis of one of the 20 supply chains. It reports the differences of the primary non-renewable energy used in different methods of cultivation and different distances between production and consumption related to one kg of bread.

Figure 3 shows the aggregate data related to the same indicator and referring to the current application of FCM in the province of Milan. It is possible to see that significant primary energy consumptions are due to the preparation of the meal followed by food production, waste management and meal consumption. It follows that the future development of the work cannot exempt itself from a deeper knowledge of the preparation of meals and related energy consumption.

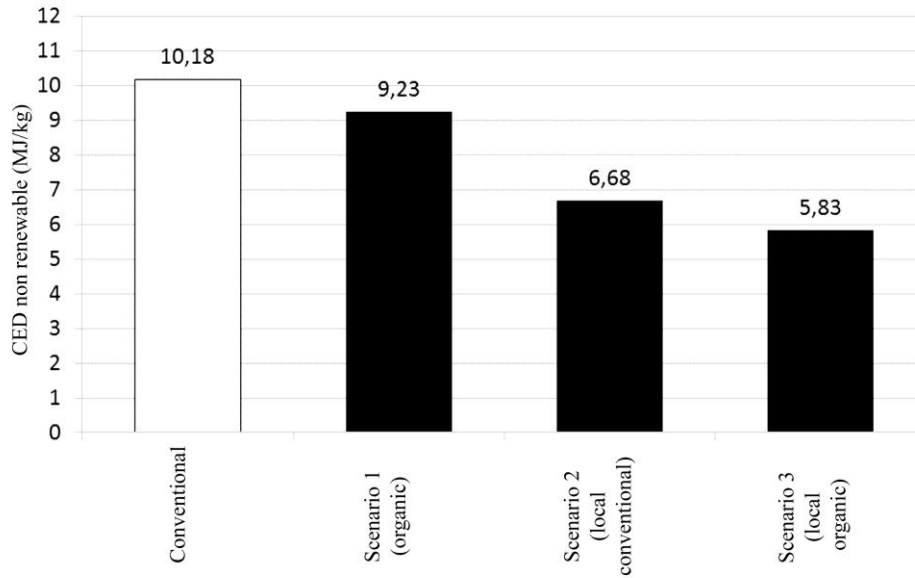

Figure 2: Comparison among the consumption of non-renewable energy source in the supply chain of 1 kg of bread (from in field production to the cooking facility delivery). It considers the production from conventional agriculture, organic agriculture (scenario 1), locally produced conventional (scenario 2), locally produced organic agriculture (scenario 3)

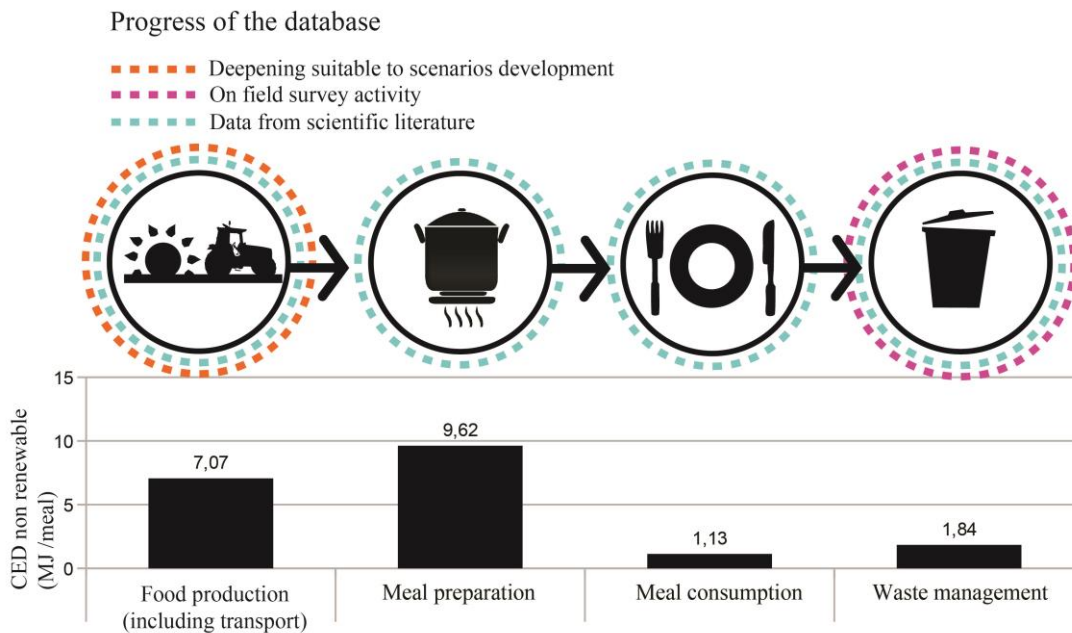

Figure 3: Primary energy consumption in the main steps of the supply chain of a meal (representative of the average annual consumption), correlated to information showing the current level of development of the database supporting the assessment model (FCM)

## 5. References

- [1] Clementi, M., Ducoli, C., Scudo, G., 'Potenzialità di utilizzo del metodo LCA nella ristorazione collettiva', in 'Life Cycle Assessment e ottimizzazione ambientale: esempi applicativi e sviluppi metodologici', Conference proceedings, Milano, 27- 28 June (2013).
- [2] Hischer, R., Weidema B., et al., 'Implementation of Life Cycle Impact Assessment Methods. Ecoinvent Report No. 3, v2.2'. Swiss Centre for Life Cycle Inventories, Dübendorf, Switzerland, (2010).
- [3] Nemecek, T., Kägi, T., 'Life Cycle Inventories of Agricultural Production Systems; Ecoinvent Report No. 15, v2.0'; Agroscope Reckenholz-Taenikon Research Station ART, Swiss Centre for Life Cycle Inventories: Zurich and Dübendorf, Switzerland, December (2007).
- [4] Nielsen, P. H., Nielsen A. M., Weidema B. P., Dalgaard, R., Halberg N., 'LCA food data base' (2003). Available online: [www.lcafood.dk](http://www.lcafood.dk).
- [5] Istat, Italian National Institute of Statistics, 'Data warehouse del 6° Censimento Generale dell'Agricoltura' (2012). Available online: <http://dati-censimentoagricoltura.istat.it>
- [6] Ducoli, C., Clementi, M., Caputo, P., Scudo, G., 'I quaderni di Bioregione, Modulo Scarti Energia e Ambiente', n.1, under publication, 2015, downloadable from October 2015 from the website [www.bioregione.eu](http://www.bioregione.eu).
- [7] Caputo, P., Ducoli, C., Clementi, M., 'Strategies and Tools for Eco-Efficient Local Food Supply Scenarios', in *Sustainability* 6, (2014), pag 631-651.

---

## Notes

- [<sup>1</sup>] Key Note (2013). Market report plus 2013: ready meals. Teddington, UK.
- [<sup>2</sup>] Sheely, M. (2008). Global adoption of convenience foods. *Am. J. of Agricultural Economics* 90(5) 1356-1365.
- [<sup>3</sup>] Mintel (2013). Prepared meals – UK – May 2013. <http://academic.mintel.com/display/664508>.
- [<sup>4</sup>] Millstone, E. and Lang, T. (2008). The Atlas of food: who eats what, where, and why (2<sup>nd</sup> ed.). Earthscan: London.
- [<sup>5</sup>] ILO (2014). Database on Labour Statistic. LABORSTA Internet. <http://laborsta.ilo.org>.
- [<sup>6</sup>] Skrivankova, K. (2014). Modern slavery: how can we end forced labour in the UK? York: Joseph Rowntree Foundation. [www.jrf.org.uk/publications/forced-labour-united-kingdom](http://www.jrf.org.uk/publications/forced-labour-united-kingdom).
- [<sup>7</sup>] CFA (2014). Healthy Eating. Chilled Food Association.
- [<sup>8</sup>] Defra. (2014). Food statistics pocketbook, 2013 update. [www.gov.uk](http://www.gov.uk).
- [<sup>9</sup>] Scarborough, P., Bhatnagar, P., Wickramasinghe, K. K., Allender, S., Foster, C. and Rayner, M. (2011). The economic burden of ill health due to diet, physical inactivity, smoking, alcohol and obesity in the UK: an update to 2006–07 NHS costs. *Journal of Public Health* 33(4) 527-535.
- [<sup>10</sup>] McPherson, K. (2014). Reducing the global prevalence of overweight and obesity. *The Lancet* 384(9945) 728-730.
- [<sup>11</sup>] WHO/FAO (2003). Diet, nutrition and the prevention of chronic diseases. Geneva: WHO/FAO.
- [<sup>12</sup>] Downing, E., and Harker, R. (2012). Food prices and affordability - commons library standard note. [www.parliament.uk/business/publications/research/briefing-papers/SN06436/food-prices-and-affordability](http://www.parliament.uk/business/publications/research/briefing-papers/SN06436/food-prices-and-affordability).
- [<sup>13</sup>] WHICH? (2013). Cutting back and trading down: the impact of rising food prices. WHICH?, 19 November 2013. [www.staticwhich.co.uk/documents/pdf/which-report-cutting-back-and-trading-down-the-impact-of-rising-food-prices-341023.pdf](http://www.staticwhich.co.uk/documents/pdf/which-report-cutting-back-and-trading-down-the-impact-of-rising-food-prices-341023.pdf).

## *Acknowledgements*

Rete Italiana LCA acknowledges the **scientific committee** for their precious contribution in evaluating the abstracts and in defining the conference program and the **organising committee** for their valuable commitment

The conference is organized in cooperation with **Livestock Environmental Assessment and Performance (LEAP) Partnership**



Rete Italiana LCA acknowledges **Nestlé** for its generous financial support to the organisation of lunches during the Conference in Stresa



Rete Italiana LCA acknowledges **Selerant** for its financial support to the organisation of the coffee-breaks during the Conference in Stresa



Published by ENEA  
Relations and Communication Unit

Lungotevere Thaon di Revel, 76  
00196 Rome  
*www.enea.it*

Editorial review: Giuliano Ghisu  
Cover design: Cristina Lanari  
On-line in October 2015