

Article

Exploiting Olive Mill Wastewater via Thermal Conversion of the Organic Matter into Gaseous Biofuel—A Case Study

Alfredo Crialesi ¹, Barbara Mazzarotta ^{1,*} , Marco Santalucia ², Fabrizio Di Caprio ³ , Alfonso Pozio ⁴, Alessia Santucci ⁵  and Luca Farina ^{5,*} 

¹ Dipartimento di Ingegneria Chimica Materiali Ambiente, “Sapienza” Università di Roma, Piazzale Aldo Moro 5, 00185 Rome, Italy; alfredocrialesi@gmail.com

² Azienda Della Toffola S.p.A., Via Feltrina, 72, 31040 Signoressa di Trevignano, Italy; msantalucia@dellatoffola.it

³ Dipartimento di Chimica, “Sapienza” Università di Roma, Piazzale Aldo Moro 5, 00185 Rome, Italy; fabrizio.dicaprio@uniroma1.it

⁴ ENEA-TERIN, C.R. Casaccia, Via Anguillarese 301, 00123 Roma, Italy; alfonso.pozio@enea.it

⁵ ENEA-FSN, C.R. Frascati, Via Enrico Fermi, 45, 00044 Frascati, Italy; alessia.santucci@enea.it

* Correspondence: barbara.mazzarotta@uniroma1.it (B.M.); luca.farina@enea.it (L.F.)

Abstract: Olive oil is one excellence of the Italian food industry: around 300 kt yr⁻¹ are produced, creating roughly the same amount of olive mill wastewater (OMW) to be disposed of. The present work describes a process to exploit OMW by converting its organic compounds to valuable gaseous biofuel. A sample OMW was characterized (COD, TOC, solids, and polyphenols) and submitted to membrane filtration tests to concentrate the organic compounds. Based on the results of the experiments, a treatment process was outlined: the retentate streams from microfiltration and ultrafiltration steps were fed to a cracking and a steam reforming reactor, respectively; the obtained syngas streams were then mixed and sent to a methanation reactor. The process was simulated with Aspen Plus (AspenTech©) software, assessing operating conditions and streams compositions: the final biofuel is around 81 mol.% methane, 4 mol.% hydrogen, and 11 mol.% carbon dioxide. The permeate stream cannot be directly disposed of, but both its amount and its polluting charge are greatly reduced. The heat needed by the process, mainly due to the endothermic reactions, can be obtained by burning an amount of olive pomaces, roughly corresponding to one-third of the amount left by olive treatments giving rise to the processed OMW feed.

Keywords: olive mill wastewater; membrane filtration; biofuel; steam reforming; cracking; methanation



Citation: Crialesi, A.; Mazzarotta, B.; Santalucia, M.; Di Caprio, F.; Pozio, A.; Santucci, A.; Farina, L. Exploiting Olive Mill Wastewater via Thermal Conversion of the Organic Matter into Gaseous Biofuel—A Case Study. *Energies* **2022**, *15*, 2901. <https://doi.org/10.3390/en15082901>

Academic Editors: José Carlos Magalhães Pires and Petar Varbanov

Received: 6 March 2022

Accepted: 13 April 2022

Published: 15 April 2022

Publisher's Note: MDPI stays neutral with regard to jurisdictional claims in published maps and institutional affiliations.



Copyright: © 2022 by the authors. Licensee MDPI, Basel, Switzerland. This article is an open access article distributed under the terms and conditions of the Creative Commons Attribution (CC BY) license (<https://creativecommons.org/licenses/by/4.0/>).

1. Introduction

Olive oil is increasingly appreciated, due to its healthy properties and excellent flavor, driving a corresponding increase in olive oil consumption and production, which more than doubled over the last 30-year period [1,2], as shown in Figure 1, exceeding 3 Mt in 2020. Around 2 Mt yr⁻¹ of olive oil is produced in the EU: the main Member States involved are Spain (66% of EU production), Italy (15%), and Greece (13%) [3]. EU quality labels showing protected designation of origin (PDO) and protected geographical indication (PGI) have already been registered for roughly 120 different types of olive oil, more than 40 of which are produced in Italy, and about 30 each in Spain and Greece [3]. In the EU olive plantations cover around 5 Mha, mostly in Spain (53%), followed by Italy (22%); around 1,500,000 farms are involved in olive production, mostly in Italy (33%) and Greece (30%) [3]. These data indicate that in Italy olive oil production is fragmented into several small farms: the average size of olive plantations per farm is around 2 ha, much lower than in Spain (5.8 ha).

Olive oil is obtained by mechanical extraction: the olives are cleaned, then pass into the grinder (mill), maintained at a temperature below 27 °C (cold extraction). Finally, the olive

oil is separated from the remaining solid, which consists of a mixture of olive pulps and pits, called olive pomace, using traditional presses, two-phase decanters, or three-phase centrifugation systems.

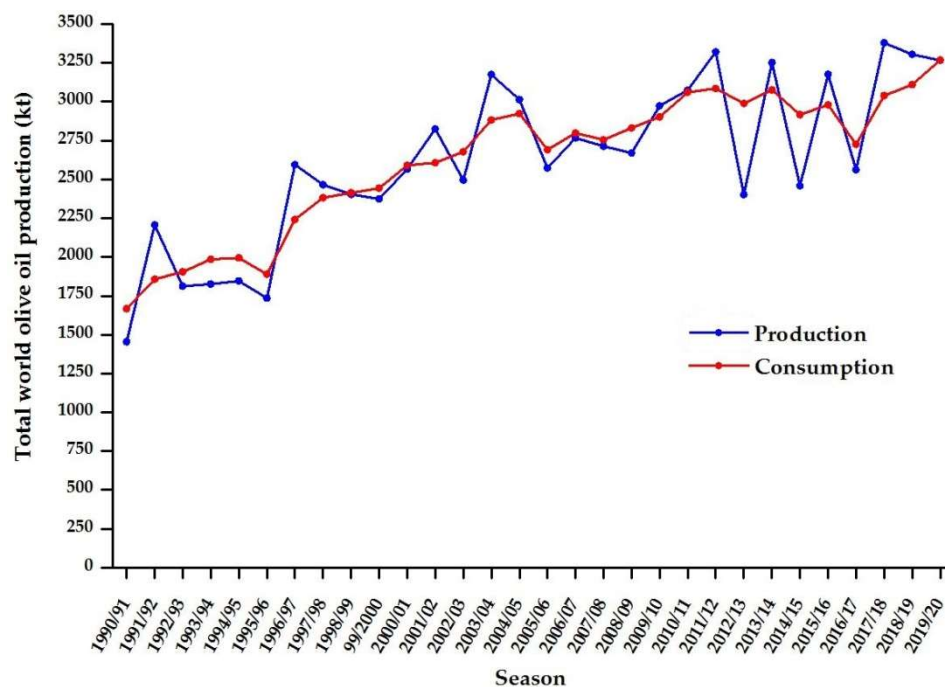

Figure 1. Trend of world consumption and production of olive oil from 1990 to 2020 [1,2].

Water consumption mainly depends on the pressing method: the amount of olive mill wastewater (OMW) ranges from 0.3 to 1.2 m³ t⁻¹ of processed olives: in particular, three-phase milling, where water is added to improve the fluidity of the olive paste, is the method originating the highest amount of OMW. On average, processing 1000 kg of olives using a three-phase centrifugation system requires the addition of 1000 kg of water [4] and gives rise to about 200 kg of oil, 600 kg of olive pomace, and 1200 kg of vegetation wastewater.

OMW presents a strong pungent smell; high content of solid matter (up to 20 g L⁻¹); low pH, in the range 2.5–5; COD value up to 220 g L⁻¹; and COD/BOD5 ratios in the range 2.5–5, indicating a poor biodegradability, mainly associated to its high content of polyphenols (up to 80 g L⁻¹) [5–8], and exhibiting antioxidant and antibacterial effects [4]. OMW composition is greatly variable depending on the region, age, and growth of the olive trees and on milling and processing techniques: water is in the range 83–94 wt.%, organic matter in the range 4–16 wt.%, and minerals are in the range 0.4–2.5 wt.% [9]. Phenolic compounds, which are highly pollutant and phytotoxic [4], represent around 2–15% of the organic fraction [9].

The direct discharge of OMW in superficial water bodies is forbidden and, in most cases, it is disposed of in open evaporating ponds or spread on agricultural lands: the first practice requires large areas, causes odor nuisance, and produces a sludge difficult to remove, the latter may be beneficial when applied at controlled rates. On the other hand, uncontrolled disposal of OMW on soils can cause serious problems: soluble polyphenols have phytotoxic and antimicrobial effects; lipids increase soil hydrophobicity and decrease water retention; and low pH and high mineral content affect soil acidity, salinity, and nutrient leakage [10,11]. It is suggested [12] that safe use of OMW in agriculture may require the reduction of suspended solids, noxious odors, polyphenols and high organic matter content, heat sterilization, and further purification using ion exchange, but also that OMW should be applied to selected crops, at specific spreading rates and timing, at the right leaf stage of crops and under some weather conditions.

Physical-chemical treatments and oxidation processes can be also applied for OMW reclamation [13]: they include wet oxidation, Fenton advanced oxidation, ozonation, coagulation-flocculation based treatments, photocatalytic treatments, and electrochemical processes. In recent years integrated membrane processes have been proposed for the treatment and/or valorization of OMW [14]: different combinations of microfiltration (MF), ultrafiltration (UF), nanofiltration (NF), and reverse osmosis (RO) have been proposed, depending on the final destination of permeate and retentate streams. Membrane filtration processes are capable of reducing the polluting charge of OMW, before the reuse of the water or its treatment in conventional facilities, but also of concentrating the organic matter, which may be a source of valuable biophenolic fraction [15–17]. OMW valorization may include second oil extraction, gasification, anaerobic digestion, and composting to produce fertilizers and biopolymers [4,16]. However, membrane treatments present a number of limitations, due to OMW characteristics: high total suspended solids concentration, high viscosity, and high osmotic pressure. Given this, the membrane may undergo severe fouling and proper operating modalities should be adopted to reduce this undesired phenomenon [18]. Catalytic reforming of OMW has been studied in both traditional [19] and membrane reactors [20–22], which were capable to produce syngas consisting of hydrogen, CO₂, and methane. In particular, the hydrogen yield achieved 2–3 kg per ton of OMW treated. The high dilution of the OMW could significantly reduce the energy efficiency of the reforming processes in which, indeed, the liquid phase has to be concentrated before its gasification. In alternative to this OMW pretreatment, the combined reforming of OMW and methane [23] or bioethanol [24] has been proposed in order to use the excess water in OMW for the reforming of the added hydrocarbon or alcohol.

The annual amount of OMW produced in Italy, where 3-phase centrifugation is generally preferred, is estimated at around 3 Mm³: managing such a huge quantity of liquid wastes is a real problem, due to their high polluting capacity, the rather short time interval (few months in the year) when they are produced, and the great number of small-medium enterprises involved. In Italy, the legislative decree 152/06 identifies OMW as a manufacturing by-product, to be committed exclusively to authorized subjects, to be possibly exploited or to be disposed of only if this is not possible. However, the most common practice of managing OMW is their controlled land spreading, ruled by the law 574/96: an annual limit of 50 and 80 m³ ha⁻¹ is established for wastewater derived from traditional or continuous olive mills, respectively, but the rather high costs of this procedure (5–20 € m⁻³ of OMW) may encourage the manufacturers to exceed the above limits, with detrimental consequences for the environment. Several studies have taken into account the recovery of methane from anaerobic digestion of the OMW. However, the major limitation is the inhibition of methanogenic bacteria by simple phenolic compounds, certain organic acids and polyphenols: due to this, pretreatment methods are needed, aiming to remove these natural inhibitors improving digestion of OMW [25].

This work analyzes the technical feasibility of the conversion of the organic compounds of OMW into valuable gaseous products by thermal conversion. Membrane separation experiments were performed on a sample of OMW to define the operating sequence and characterize the obtained permeate and retentate streams. This information was used to determine the characteristics of the feed to the conversion process, where syngas is obtained by cracking and steam reforming reactions. A final methanation step was adopted to reduce the carbon dioxide and increase the methane concentration of the gaseous biofuel. Operating conditions of the main equipment, heat, and mass balances were determined by means of process simulation software.

2. Materials and Methods

2.1. Experimental

The OMW used in the experiments has been supplied from Carlini enterprise, an olive mill processing about 10 t of olives per day. In particular, the OMW was derived from the treatment of a mix of different cultivars in the surrounding Arsoli (Italy) and was obtained

from a vertical 3-phase centrifuge. A total volume of about 33 L of OMW was stored in polypropylene tanks for food use, immediately transported to ENEA Research Centre in Frascati, and placed in a freezer to preserve its original characteristics.

The organic matrix contained in OMW is, as usual, very diluted and, therefore, should be concentrated before being fed to a conversion process. To this end, membrane filtration experiments were performed by Della Toffola S.p.A. (Trevignano, Italy), a company which is specialized in advanced technology for agriculture [26], in its facility in Trevignano (Italy). Generally speaking, membrane filtration technology is widely used for the treatment and purification of wastewaters and, therefore, it has been taken into account to exploit its efficiency in concentrating the organic matter of the OMW.

The experiments consisted of submitting the OMW to batch filtration using tubular ceramic membrane modules: their characteristics are listed in Table 1.

Table 1. Characteristics and operating conditions of the membrane modules.

Characteristics of the Membranes	Value
Number of channels	7
Diameter of each channel	2 mm
Length of each module	0.25 m
Permeable surface	0.034 m ²
Trans-membrane pressure	1.5 bar (MF)/2 bar (UF)
Tangential flux velocity	2.5 m s ⁻¹ (UF)/3 m s ⁻¹ (MF)
Permeate flux	60 L h ⁻¹ m ⁻² (UF)/90 L h ⁻¹ m ⁻² (MF)

Batch runs were performed, recirculating the retentate until the desired separation targets were reached. A first attempt, adopting a single MF step was not satisfactory in terms of organic matter concentration, and a double step treatment, shown in Figure 2, was preferred. It consisted of a microfiltration step (pore size 1.4 µm) reducing the permeate volume to 60% of the original OMW feed volume, followed by an ultrafiltration step (300 kDa, equal to a pore size of 9 nm) of the obtained permeate.

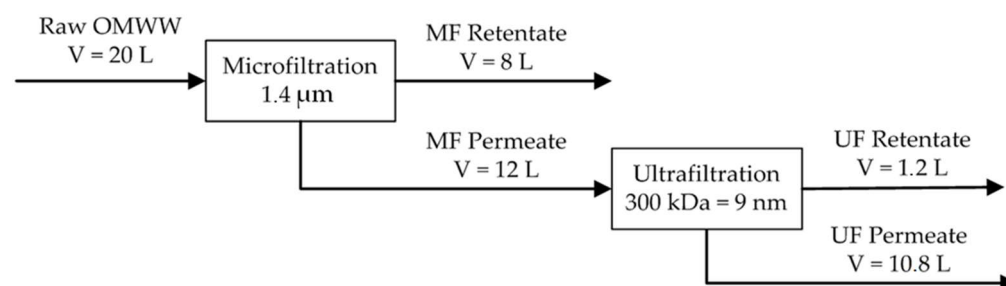

Figure 2. Scheme of adopted membrane filtration.

Raw OMW, as well as the streams obtained from membrane separation, were characterized in terms of COD, TOC, suspended solids, and total polyphenols; the results are listed in Table 2. Details about experimental procedures, analytical techniques, and used instrumentation are reported elsewhere [27].

The characteristics of the retentate streams obtained from the MF and UF steps of the process are rather different; as shown in Figure 2, the amount of the retentate from the MF step is about seven times that from the UF step. Table 2 shows that TOC concentration, which is an index of the organic matter content of the stream, is also higher for MF retentate than for UF one: this result may suggest adopting different strategies to process these two streams.

Table 2. Characterization of the OMW upstream and downstream of the filtration.

Sample	TOC (g L ⁻¹)	TOC _{St. Dev.} (g L ⁻¹)	COD (gO ₂ L ⁻¹)	Total Solids (mL L ⁻¹)	Total Polyphenols [28] ¹ (g _{GAE} L ⁻¹)
Raw OMW	12.46	±0.58	91.70	100	0.39
MF Retentate	22.77	±1.41	77.75	150	0.04
MF Permeate	3.57	±1.12	32.67	<10	0.25
UF Retentate	10.35	±0.49	29.75	10	0.45
UF Permeate	2.33	±0.07	34.25	<10	0.12

¹ GAE: Gallic Acid Equivalent.

It has also to be noticed that a substantial reduction of the polluting content of the permeate stream from the UF is also obtained: TOC decreased by 81.3%, COD by 62.6%, and total polyphenols by 58%.

2.2. Conversion Reactions

In the past years, ENEA carried out some experiments in Frascati laboratories to demonstrate that ultrapure hydrogen can be obtained by submitting to reforming OMW, using special membrane reactors, provided with Pd alloy tubes to separate the produced hydrogen [23,24]. The experience gained from this process suggested the investigation of the possible use of OMW as a substrate to obtain syngas.

Most recently several studies have taken into account the catalytic steam reforming of synthetic OMW for high selectively hydrogen production [29,30]. These studies have shown that the H₂ yield can reach values between 8.5–10 mol_{H₂} mol⁻¹_{OMW} leading to a TOC conversion close to 100%.

Generally speaking, both thermal cracking and steam reforming reactions can be adopted to obtain syngas from the organic matrix of OMW, which is a rather heterogeneous mixture of lipids, pectin, organic acids, mucilage, carbohydrates, phenols, tannin, and lignin [31].

2.2.1. Thermal Cracking

Thermal cracking is typically endothermic and includes a number of reactions (decarboxylation, decarbonylation, and rupture of the C-C bond) originating lighter compounds, whose relative amount depends on the operating conditions adopted and on the characteristics of the feed. The main factor influencing the composition of the product is the temperature: experiments carried out on CANadian Oil Low Acid demonstrated that by increasing the temperature, the gaseous product contains more light compounds (ethylene, methane, hydrogen) and less carbon monoxide and dioxide [32]. A minimum temperature of 250–300 °C is required for the reaction, but undesired coke precipitation also starts around 300 °C, according to the reaction.



2.2.2. Steam Reforming

Steam reforming reactions, which are endothermic as well, produce hydrogen from light organic feeds. The reactions for generic oxygenated and hydrocarbon compounds can be written as follows:

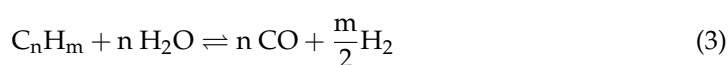
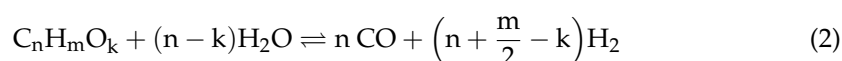

High temperature and moderate pressure conditions are generally selected, and the reaction is supported by proper catalysts (usually noble or transition metals). The amount of steam is kept in the range 2.5–3.5 with respect to the organic matter; this condition favors

the water gas shift reaction, which starts around 650 °C, converting CO into CO₂, and giving rise to additional hydrogen production.



2.2.3. Methanation

The gaseous stream obtained from thermal cracking of the organic substrate of OMW is expected to consist of a mixture of hydrogen, light hydrocarbons (mostly methane), and carbon dioxide. The stream obtained from steam reforming will contain mainly hydrogen and carbon dioxide, with traces of carbon monoxide. A high concentration of CO₂ and CO is undesirable since it will reduce the heating power of the biofuel gas. By submitting the gaseous stream to methanation reactions carbon dioxide and monoxide can be converted into methane:

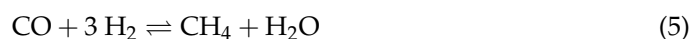

Methanation reactions are highly exothermic and are carried out at 250–400 °C, in the presence of a catalyst based on Ni combined with other substances (Ru, Rh, Pt, Fe, Co).

2.3. Conversion Process

The conversion process is schematically shown in Figure 3. A membrane pretreatment is followed by two distinct process lines, converting the retentate streams by thermal cracking or steam reforming: the obtained products are separated by the condensable fraction, mixed, and fed to the methanation reactor. The final product is the gas fraction obtained separating the condensable liquids that, in turn, should be treated and disposed of, as well as the residual permeate stream from the membrane separation step.

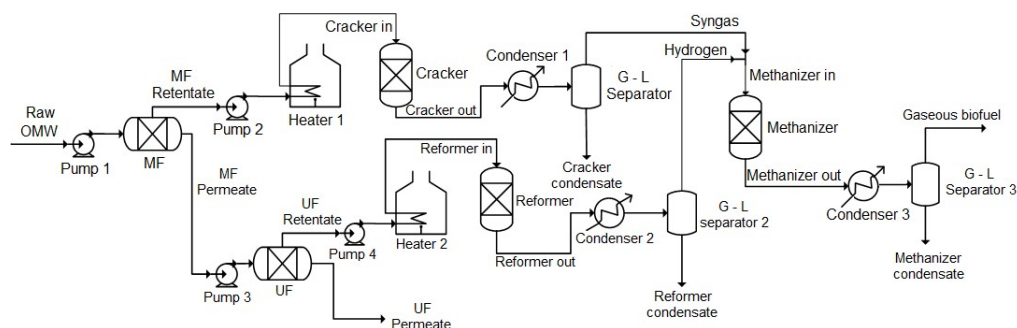

Figure 3. Scheme of the process.

Raw OMW is pumped by Pump 1 to the MF unit, which separates a concentrated retentate (MF Retentate), to be further processed, from a diluted permeate (MF Permeate), which is fed by Pump 3 to the UF unit. The permeate from this latter (UF Permeate) should be treated and disposed of, while the retentate (UF Retentate), less concentrated than the MF one, is further processed, too.

The two retentate streams obtained from MF and UF steps are different in flowrate and organic compound content terms (see Figure 2 and Table 2) but, in principle, both can proceed to thermal cracking or to steam reforming lines, as will be discussed later in detail. In general, the best results were obtained feeding: (i) the larger and more concentrated stream of retentate from the MF step to the cracking reactor, and (ii) the smaller and less concentrated retentate stream from the UF step to the reforming reactor.

Accordingly, the retentate from MF unit (MF Retentate), pumped by Pump 2, is heated to about 350 °C in the furnace Heater 1 and fed to the cracking reactor: the product (Cracker out) is cooled and condensed with tower water in Condenser 1: the gaseous fraction (Syngas) is separated from the condensed liquid (Cracker condensate) in G-L Separator 1.

The permeate stream from UF (UF Permeate) is discharged and sent to water treatment, while the retentate (UF Retentate), pumped by Pump 4, is heated and vaporized in the furnace Heater 2, up to about 700 °C, and fed to the reformer, where a hydrogen rich gaseous mixture (Reformer out) is produced. Moreover, this stream is cooled and partially condensed with tower water, in Condenser 2; gaseous fraction (Hydrogen) is separated in G-L Separator 2 from the condensable liquid fraction (Reformer condensate).

The two gaseous streams (Syngas and Hydrogen) obtained from cracking and reforming lines are mixed and fed to the methanizer; the temperature was set at 300 °C and the H₂:CO₂ operating ratio at 3.13. Although the methanation reaction would be thermodynamically favored by a moderate pressure, the pressure was not increased, to avoid the need for a compressor. The product stream is cooled and condensed in Condenser 3: from the gas-liquid separator G-L Separator 3 the final gaseous biofuel is obtained (Biofuel gas) while the liquid phase (Methanizer condensate), mainly consisting of water generated by the reactions (Equations (5) and (6)), is discharged. In the methanizer reactor, some coke is also formed; it precipitates on the catalyst which should be periodically regenerated.

3. Results

3.1. Process Simulation

3.1.1. Design Basis

A feed of 5 m³ h⁻¹ of raw OMW, as typically obtained from milling and centrifugation of 5 t h⁻¹ of olives, was considered. Such values roughly correspond to the capacity of a medium-large olive milling facility, or of a few smaller ones. It is intended that an OMW storage is provided, to allow the treatment plant to run continuously.

The composition of OMW is very complex, consisting of variable amounts of different organic compounds, mainly polyphenols, sugars, and lipids [33]. For process simulation purposes the TOC concentration of the feed was assumed to be only associated with the presence of oleic acid, which is the main constituent of the lipidic fraction which, in turn, is the main constituent of the organic matrix. Accordingly, the estimates of the composition of the products obtained from the conversion of the OMW organic compounds were based on the assumption that all organic carbon was made of oleic acid.

Table 3 shows the flow rate and composition of the raw OMW fed to the plant and the streams obtained from MF and UF separation steps, based on the results of membrane separation tests. Moreover, TOC values have been converted to oleic acid concentrations and, as stated above, reference is made to the stream's name reported in Figure 3.

Table 3. Flow rate and composition of the streams fed to the plant.

Stream	Flow Rate (L h ⁻¹)	TOC (g L ⁻¹)	Oleic Acid Equivalents (g L ⁻¹)	Oleic Acid Organic Load (kg h ⁻¹)
Raw OMW	5000	12.46	16.29	81.472
MF Retentate	2000	22.77	29.78	59.544
MF Permeate	3000	3.57	4.67	14.006
UF Retentate	300	10.35	13.54	4.061
UF Permeate	2700	2.33	3.05	8.227

3.1.2. Simulation Software and Assumptions

The simulation of the process to convert OMW into gaseous biofuel described in Figure 3 was made using Aspen Plus (AspenTech©) process simulation software, assuming stationary state conditions and NRTL thermodynamic system.

The conversion products taken into account are:

- gaseous phase: hydrogen, carbon monoxide, carbon dioxide, water, light hydrocarbons up to C₄;
- liquid phase: toluene, benzene, and water;
- solid phase: graphitic carbon.

The following simplifying assumptions were also adopted:

- adiabatic reactors were assumed for all the conversion steps;
- the reactors were modeled based on free Gibbs energy minimization criterion to reach chemical and phase equilibrium conditions, based on the knowledge of the following information: operating pressure; operating temperature, or thermic power exchanged, and chemical compounds present in the outlet stream;
- Furnaces Heater 1 and Heater 2 supply to the feed both the heat to reach the reaction temperature and that required by the endothermic cracking and reforming reactions; it is assumed the reaction to take place inside the furnace, but two distinct units were needed for simulation purpose;
- the exothermic methanation reaction was assumed as isothermal; accordingly, the equipment should be provided with a proper cooling system (jacket, coils, or external recirculation) to remove the reaction heat;
- membrane separation units were simulated based on the cut-off mass balances resulting from the experiments;
- volumetric lobular type (Pumps 1 and 2) and gear type (Pumps 3 and 4) pumps were selected, due to the low flow rate and high viscosity of the liquids streams.

3.2. Results of the Simulation

3.2.1. Thermal Cracking Section

Table 4 shows the operating conditions of each unit, i.e., reactor, condenser, and gas-liquid separator of the thermal cracking process line; Table 5 shows the flow rate and composition of the gaseous Syngas stream separated downstream of the cracking reactor.

Table 4. Operating conditions of the cracking line.

Operating Condition	Cracker	Condenser 1	G-L Separator 1
Flow rate (kg h ⁻¹)	2055.7	2055.7	2055.7
Pressure (bar)	5.0	4.8	4.5
Inlet/outlet temperature (°C)	40.0/355.9	355.9/60.0	60.0/59.9
Heat supplied (+) or removed (−) (kW)	+1730	−1591	-

Table 5. Characteristics of the syngas stream obtained from the cracking line.

Variable	Syngas Stream
Flow rate	(kg h ⁻¹) 102.8
CH ₄	(mol.%) 18.98
H ₂	(mol.%) 57.06
CO ₂	(mol.%) 19.54
CO	(mol.%) 0.06
H ₂ O	(mol.%) 4.37

It can be noticed that the gaseous Syngas stream, rich in hydrogen, also contains around 20% of both methane and carbon dioxide. The flow rate of the liquid waste obtained from the separator (Cracker condensate) is 1953 kg/h, i.e., about 20 times that of the gaseous product; it consists of 99.06 wt.% water and should undergo a water treatment process before disposal.

3.2.2. Steam Reforming Section

Table 6 shows the operating conditions of each unit, i.e., reactor, condenser, and gas-liquid separator of the steam reforming line; Table 7 shows the flow rate and composition of the gas separated downstream of the reforming reactor.

Table 6. Operating conditions of the steam reforming line.

Operating Condition	Reformer	Condenser 2	G-L Separator 2
Flow rate (kg h ⁻¹)	303.5	303.5	303.5
Pressure (bar)	7.0	6.8	6.6
Inlet/outlet temperature (°C)	40.0/702.1	702.1/60.0	60.0/60.0
Heat supplied (+) or removed (−) (kW)	+324	−303	-

Table 7. Characteristics of gaseous stream obtained from the steam reforming line.

Variable	Hydrogen Stream
Flow rate (kg h ⁻¹)	7.91
CH ₄ (mol.%)	0.01
H ₂ (mol.%)	81.38
CO ₂ (mol.%)	14.91
CO (mol.%)	0.72
H ₂ O (mol.%)	2.99

In this case, the gaseous stream is rich in hydrogen and contains around 15% of carbon dioxide, while its methane content is negligible. The liquid to gas ratio for the product from the reformer is around 38, almost double than obtained from the separator downstream of the thermal cracking reactor, even if the overall flow rate is much lower. The liquid waste (Reformer condensate) is estimated as 296 kg h⁻¹ and its water content is 99.15 wt.%; therefore, this stream should also undergo a water treatment process before disposal.

3.2.3. Methanation Section

The gaseous streams obtained from the cracking and the reforming reactors are mixed and sent to the methanation reactor; the total flow rate and composition of this feed are listed in Table 8.

Table 8. Characteristics of the stream feeding the methanation reactor.

Variable	Methanizer in Stream
Flow rate (kg h ⁻¹)	110.7
CH ₄ (mol.%)	16.99
H ₂ (mol.%)	59.60
CO ₂ (mol.%)	19.05
CO (mol.%)	0.13
H ₂ O (mol.%)	4.23

Table 9 shows the operating conditions of each unit, i.e., reactor, condenser, and gas-liquid separator of the methanation section; Table 10 shows the flow rate and composition of the final gaseous stream (Biofuel gas).

The simulation results also indicate the presence of a not negligible coke generation rate (0.73 kg h⁻¹) in the methanation reactor; this undesired phenomenon will require periodical removal and regeneration of the catalyst.

About 78 mol.% of carbon dioxide contained in the feed has been transformed into methane, consuming in the reaction the greatest part (around 97 mol.%) of the hydrogen originally present; nevertheless, carbon dioxide concentration in the final gas is still above 10%, as a consequence of the much higher flow rate of the stream obtained from the cracking line. It has to be noticed that, differently in the previous gas-liquid separations, in this case, the liquid phase (Methanizer condensate) obtained from the gas-liquid separator downstream of the methanation reactor (51 kg h⁻¹) is slightly less than the gaseous one.

On the other hand, its water content (97.01 wt.%) is lower, indicating that more drastic water treatment would be needed before disposal.

Table 9. Operating conditions of the methanation reaction line.

Operating Condition	Methanizer	Condenser 3	G-L Separator 3
Flow rate (kg h ⁻¹)	110.7	110.7	110.7
Pressure (bar)	4.0	3.8	3.5
Inlet/outlet temperature (°C)	60.0/300.0	300.1/50.0	50.0/50.0
Heat supplied (+) or removed (−) (kW)	−41.2	−49	-

Table 10. Characteristics of the final biofuel gas stream out of the methanation reactor.

Variable	Biofuel Gas
Flow rate	(kg h ⁻¹) 59.7
CH ₄	(mol.%) 81.30
H ₂	(mol.%) 4.34
CO ₂	(mol.%) 10.97
CO	(mol.%) 0.01
H ₂ O	(mol.%) 3.38

4. Discussion

The obtained results show that starting from an initial OMW flow rate of 5 m³ h⁻¹, 59.7 kg h⁻¹ of valuable biofuel gas have been obtained. This means a yield of about 1.2 wt.% reaching a TOC conversion close to 96%; this can be regarded as an encouraging result and, in principle, comparable with what has been outlined in the literature data for steam reforming of synthetic OMW [29,30]. However, other two different schemes have been devised and simulated, such as feeding the UF retentate to the cracking line and the MF retentate to the reforming one or simplifying the scheme by concentrating the feed with a single MF step and feeding the retentate to the sole reforming line, as described below.

4.1. Alternative Process Options

When the larger and more concentrated retentate stream is fed to the reformer, 148.6 kg h⁻¹ of gas is obtained downstream of the reactor, containing around 76 mol.% hydrogen and 19 mol.% carbon dioxide; on the other hand, feeding the retentate stream in the cracking line, 7.1 kg h⁻¹ of syngas is obtained, containing around 72 mol.% hydrogen, 16 mol.% carbon dioxide, and less than 8 mol.% methane. Mixing these two streams, a composition of around 76 mol.% hydrogen and 19 mol.% carbon dioxide is obtained, methane concentration being less than 0.4%. Such a hydrogen-rich stream may directly represent a valuable biofuel, provided that carbon dioxide is removed, for example, using Pressure Swing Adsorption or Temperature Swing Adsorption methods. However, feeding this stream to a methanation reactor, 53 kg h⁻¹ of gaseous products are obtained, containing around 88 mol.% methane, 4 mol.% hydrogen, and 4.5 mol.% carbon dioxide. The flow rate is 10% less than that obtained following the Figure 3 scheme, but the methane content is higher and the carbon dioxide lower. On the other hand, the thermal power required by the endothermic reactions, globally 2501 kW, increases by more than 21%. In particular the power requirement of the reformer operating at 700 °C (2245 kW), i.e., a much higher temperature with respect to the cracking unit (around 350 °C), increases by a factor of 7. All the above considered, the original scheme reported in Figure 3, seems preferable.

The second option, feeding the retentate from MF directly to the steam reformer, and just recovering the gaseous fraction of the product, after condensation, gives rise to a greater amount of gaseous product (142.5 kg h⁻¹) with a high hydrogen content (around 78 mol.%), but also containing more than 18% of undesired carbon dioxide. The process is

greatly simplified by the absence of UF, cracking, and methanation units, but a much larger reformer unit will be needed. The thermal power required by steam reforming reaction is 1611 kW, around 78% of that globally required by cracking and reforming units in the scheme of Figure 3; on these bases, the last option was abandoned.

4.2. Biofuel Composition

Focusing the attention again on the original scheme of Figure 3, the final composition of the biofuel gas greatly depends on the operating conditions adopted in the methanation reactor. Figure 4 shows the trends of methane, hydrogen, carbon dioxide, and water concentration in the reactor vs. the temperature, as obtained from the process simulator.

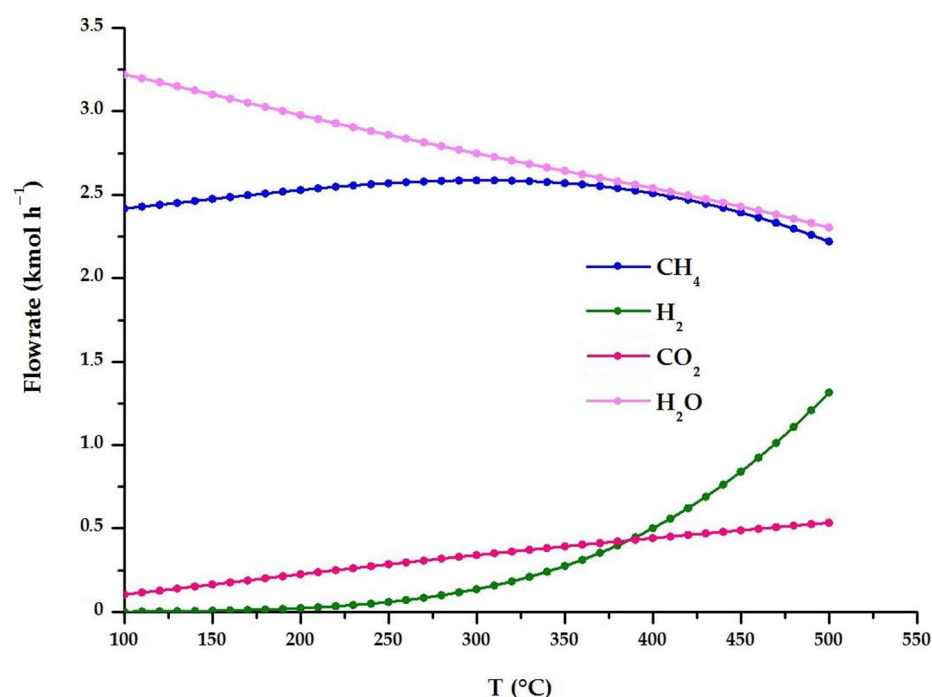

Figure 4. Methane, hydrogen, carbon dioxide, and water concentration in the methanation reactor as a function of the temperature.

Based on this diagram, the methane content of the final gaseous biofuel is maximized around 300–310 °C.

4.3. Heat Balance

The heat power required to sustain the endothermic reactions into cracking and reforming reactors shown in Figure 3 is 2.05 MW (see Tables 8 and 9); such an amount is not particularly high, and, therefore, conservatively assuming an overall efficiency of heat exchange in the furnace around 60%, it can be estimated that 3.5 MW should be supplied for the syngas production upstream the methanation. This energy can be obtained from conventional fuels, such as methane, but a more sustainable option would be to recover heat by the combustion of olive pomace. The heating power of olive pomace lies in the range of 13.4–15.9 MJ kg⁻¹ [34] depending on its oil and pits content, and on the ratio of pulps to pits. Assuming the lower figure, to obtain 3.5 MW, around 940 kg h⁻¹ of olive pomace should be burnt. This flow rate is not a particularly high value, bearing in mind that the plant is fed with OMW deriving from the processing of 5000 kg h⁻¹ of olives which, typically, originate 3000 kg h⁻¹ of olive pomace.

Finally, the scheme of Figure 3 suggests that some heat recovery among process streams is possible; in fact, the temperatures of the inlet streams to the reactors are in the range of 40–60 °C, the operating temperatures of the reactors in the range of 300–700 °C,

and the outlet streams from the reactors need to be cooled and condensed, down to a temperature of 50–60 °C. In the scheme, it was assumed to supply heat in the furnace and to remove heat with tower water; for a water temperature rise of 25 °C, a flow rate around 58 m³ h⁻¹ will occur. Heat recovery can be provided by heat exchange between the feed and the product streams of each reactor: however, the flow rates of the process streams are very low, and most of the heat needed by the process depends on the endothermic reactions taking place in the cracking and reforming units. Assuming a minimum temperature difference of 15 °C among the streams, around 0.7 MW can be globally recovered; this will reduce both the heat to be supplied and that to be removed.

5. Conclusions

Based on an experimental data set, a conceptual design of a novel process capable of producing gaseous biofuel from the organic matter of the OMW has been presented.

Laboratory-scale membrane filtrations were performed, aiming to concentrate the organic matter of the OMW in the retentate streams of MF and UF steps.

The composition of the organic matter both of raw OMW and downstream the filtrations has been characterized in terms of TOC, COD, total solids, and total polyphenols.

Under the assumption that all organic carbon was made of oleic acid, thermal processes based on cracking and steam reforming have been evaluated to investigate the conversion of the organic matter into syngas.

Both the gaseous products obtained from cracking and reforming contain 15–20 mol.% carbon dioxide, which can be partially converted to methane in a methanation reactor. From a feed of 5 m³ h⁻¹, a final flow rate of 59.7 kg h⁻¹ of biofuel gas consisting of 81 mol.% methane and residual content of carbon dioxide less than 11 mol.% is obtained.

It has been evaluated that the heat requirements of the process, mainly associated with the thermal cracking and steam reforming reactions, could be supplied by the combustion of a reasonably low flow rate of olive pomace corresponding to less than 1 t h⁻¹, i.e., one-third of the total production.

Further investigation will be needed to assess operating and investment costs that could be rather high due to the number of needed equipment, the operating conditions of the reactors, the regeneration of catalyst, and the cleaning operations of the membranes. However, savings could be expected following the significant decrease in terms of volume (54%) and organic pollutant load (81%) of the liquid wastes to dispose of.

Author Contributions: Conceptualization, A.C., L.F. and B.M.; methodology, A.C., L.F., M.S., F.D.C. and B.M.; software, A.C., B.M. and L.F.; validation, L.F., B.M., F.D.C., A.S. and A.P.; formal analysis, A.C., L.F., M.S., F.D.C., B.M., A.S. and A.P.; investigation, A.C., L.F., M.S., F.D.C., B.M., A.S. and A.P.; data curation, A.C., L.F., F.D.C. and B.M.; writing—original draft preparation, B.M. and L.F.; writing—review and editing, B.M., L.F., A.S. and F.D.C.; visualization, A.C., L.F., M.S., F.D.C., B.M., A.S. and A.P.; supervision, B.M. and L.F. All authors have read and agreed to the published version of the manuscript.

Funding: This research received no external funding.

Acknowledgments: This study was performed in the framework of the “Membrane-lab.” research activity. The authors would like to thank *Silvano Tosti*. Furthermore, all of the authors would like to thank the external collaborators that were involved, namely “*Frantoio Carlini*”, *Francesco Petrazzuolo* and *Annalaura Iannone*.

Conflicts of Interest: The authors declare no conflict of interest.

References

1. International Olive Oil Council (IOOC). Available online: <https://www.internationaloliveoil.org/wp-content/uploads/2020/12/HO-W901--17--12--2021-C.pdf> (accessed on 17 January 2022).
2. International Olive Oil Council (IOOC). Available online: <https://www.internationaloliveoil.org/wp-content/uploads/2020/12/HO-W901--17--12--2021-P.pdf> (accessed on 17 January 2022).

3. The EU Olive and Olive Oil Sector—Main Features, Challenges and Prospects, Briefing, September 2017. Available online: [https://www.europarl.europa.eu/thinktank/en/document/EPRS_BRI\(2017\)608690](https://www.europarl.europa.eu/thinktank/en/document/EPRS_BRI(2017)608690) (accessed on 17 January 2022).
4. Morillo, J.A.; Antizar-Ladislao, B.; Monteoliva-Sánchez, M.; Ramos-Cormenzana, A.; Russell, N.J. Bioremediation and biovalorization of olive-mill wastes. *Appl. Microb. Biotech.* **2009**, *82*, 25–39. [[CrossRef](#)] [[PubMed](#)]
5. Tsagaraki, E.; Lazarides, H.N.; Petrotos, K.B. Olive mill wastewater treatment. In *Utilization of By-Products and Treatment of Waste in Food Industry*; Oreopoulou, V., Winfried, R., Eds.; Springer Science + Business Media: New York, NY, USA, 2007; pp. 133–157.
6. Amaral, C.; Lucas, M.S.; Coutinho, J.; Crespi, A.L.; Anjos, M.D.R.; Pais, C. Microbiological and physicochemical characterization of olive mill wastewaters from a continuous olive mill in Northeastern Portugal. *Bioresour. Technol.* **2008**, *99*, 7215–7223. [[CrossRef](#)] [[PubMed](#)]
7. Coz, A.; Villegas, M.; Andre, A.; Viguri, J.R.; Mantzavinos, D.; Xekoukoulotakis, N.P. Management scenarios for olive oil mill waste based on characterization and leaching tests. *J. Chem. Technol. Biotechnol.* **2011**, *86*, 1542–1547. [[CrossRef](#)]
8. De Marco, E.; Savarese, M.; Paduano, A.; Sacchi, R. Analytical, nutritional and clinical methods e characterization and fractionation of phenolic compounds extracted from olive oil mill wastewaters. *Food Chem.* **2007**, *104*, 858–867. [[CrossRef](#)]
9. Davies, L.C.; Vilhena, A.M.; Novais, J.M.; Martins-Dias, M. Olive mill wastewater characteristics: Modeling and statistical analysis. *Grasas Aceites* **2004**, *66*, 233–241. [[CrossRef](#)]
10. Sierra, J.; Marti, E.; Garau, M.; Cruanas, R. Effect of the agronomic use of olive oil wastewater: Field experiments. *Sci. Total Environ.* **2007**, *378*, 90–94. [[CrossRef](#)]
11. Fiorentino, A.; Gentili, A.; Isidori, M.; Monaco, P.; Nardelli, A.; Parrella, A. Environmental effects caused by olive mill wastewaters: Toxicity comparison of low-molecular-weight phenol components. *J. Agric. Food Chem.* **2003**, *51*, 1005–1009. [[CrossRef](#)]
12. Koutsos, T.M.; Chatzistathis, T.; Balampekou, R.L. A new framework proposal, toward a common EU agricultural policy, with the best sustainable practice for the re-use of olive mill wastewater. *Sci. Total Environ.* **2017**, *622–623*, 942–953. [[CrossRef](#)]
13. Ochando-Pulido, J.M.; Pimentel-Moral, S.; Verardo, V.; Martinez-Ferez, A. A focus on advanced physico-chemical processes for olive mill wastewater treatment. *Sep. Purif. Technol.* **2017**, *19*, 161–174. [[CrossRef](#)]
14. Gebreyohannes, A.Y.; Mazzei, R.; Giorno, L. Trends and current practices of olive mill wastewater treatment: Application of integrated membrane processes and its future perspectives. *Sep. Purif. Technol.* **2016**, *162*, 45–60. [[CrossRef](#)]
15. Russo, C. A new membrane process for the selective fractionation and total recovery of polyphenols, water and organic substances from vegetation waters (VW). *J. Membr. Sci.* **2007**, *288*, 239–246. [[CrossRef](#)]
16. Cassano, A.; Conidi, C.; Giorno, L.; Drioli, E. Fractionation of olive mill wastewaters by membrane separation techniques. *J. Hazard. Mater.* **2013**, *248–249*, 185–193. [[CrossRef](#)] [[PubMed](#)]
17. Roig, A.; Cayulea, M.L.; Sánchez-Monedero, M.A. An overview on olive mill wastes and their valorization methods. *Waste Manag.* **2006**, *26*, 960–969. [[CrossRef](#)] [[PubMed](#)]
18. Stoller, M.; Azizova, G.; Mammadova, A.; Vilardi, G.; Di Palma, L.; Chianese, A. Treatment of olive oil processing wastewater by ultrafiltration, nanofiltration reverse osmosis and biofiltration. *Chem. Eng. Trans.* **2016**, *47*, 409–414.
19. Casanovas, A.; Galvis, A.; Llorca, J. Catalytic steam reforming of olive mill wastewater for hydrogen production. *Int. J. Hydrogen Energy* **2015**, *40*, 7539–7545. [[CrossRef](#)]
20. Tosti, S.; Accetta, C.; Fabbicino, M.; Sansovini, M.; Pontoni, L. Reforming of olive mill wastewater through a Pd-membrane reactor. *Int. J. Hydrogen Energy* **2013**, *38*, 10252–10259. [[CrossRef](#)]
21. Tosti, S.; Sansovini, M. A process for treating waste waters of oil mills by means of reforming reactions, and plant therefor. European Patent No. 13829002.8, 15 February 2017.
22. Tosti, S.; Cavezza, C.; Fabbicino, M.; Pontoni, L.; Palma, V.; Ruocco, C. Production of hydrogen in a Pd-membrane reactor via catalytic reforming of olive mill wastewater. *Chem. Eng. J.* **2015**, *275*, 366–373. [[CrossRef](#)]
23. Tosti, S.; Fabbicino, M.; Pontoni, L.; Palma, V.; Ruocco, C. Catalytic reforming of olive mill wastewater and methane in a Pd-membrane reactor. *Int. J. Hydrogen Energy* **2016**, *41*, 5465–5474. [[CrossRef](#)]
24. Alique, D.; Bruni, G.; Sanz, R.; Calles, J.A.; Tosti, S. Ultra-Pure Hydrogen via Co-Valorization of Olive Mill Wastewater and Bioethanol in Pd-Membrane Reactors. *Processes* **2020**, *8*, 219. [[CrossRef](#)]
25. Messineo, A.; Picciotto Maniscalco, M.; Volpe, R. Biomethane recovery from olive mill residues through anaerobic digestion: A review of the state of the art technology. *Sci. Total Environ.* **2020**, *703*, 135508. [[CrossRef](#)]
26. Della Toffola. Available online: www.dellatoffola.it (accessed on 26 January 2022).
27. Cialesi, A. Trattamento delle Acque di Vegetazione dei Frantoi Oleari Mediante un Processo di Separazione a Membrane e Reforming. Master’s Thesis, “Sapienza” University of Rome, Rome, Italy, 20 January 2021.
28. Singleton, V.L.; Orthofer, R.; Lamuela-Raventós, R.M. Analysis of total phenols and other oxidation substrates and antioxidants by means of Folin-Ciocalteu reagent. *Methods Enzymol.* **1999**, *299*, 152–178.
29. Rocha, C.; Soria Luís, M.A.; Madeira, M. Screening of commercial catalysts for steam reforming of olive mill wastewater. *Renew. Energy* **2021**, *169*, 765–779. [[CrossRef](#)]
30. Rocha, C.; Soria Luís, M.A.; Madeira, M. Use of Ni-containing catalysts for synthetic olive mill wastewater steam reforming. *Renew. Energy* **2022**, *185*, 1329–1342. [[CrossRef](#)]
31. Paraskeva, P.; Diamadopoulos, E. Technologies for olive mill wastewater (OMW) treatment: A Review. *J. Technol. Biotechnol.* **2006**, *81*, 1475–1485. [[CrossRef](#)]

32. Idem, R.O.; Katikaneni, S.P.R.; Bakhshi, N.N. Thermal cracking of Canola oil: Reaction products in the presence and absence of steam. *Energy Fuel* **1996**, *10*, 1150–1162. [[CrossRef](#)]
33. Goula, A.M.; Adamopoulos, K.G. A Method for Preparing a Novel Solid Product from Olive Mill Wastewater: Wastewater Characterization and Product Recovery, Drying Technology. *Dry Technol.* **2013**, *31*, 339–349. [[CrossRef](#)]
34. International Olive Oil Council (IOOC). *Olive Oil Quality Improvement*; International Olive Oil Council: Madrid, Spain, 1990.