

PAPER • OPEN ACCESS

Remote maintenance in IFMIF-DONES: current status and future development program

To cite this article: G. Miccichè *et al* 2025 *Nucl. Fusion* **65** 122007

View the [article online](#) for updates and enhancements.

You may also like

- [The IFMIF-DONES fusion oriented neutron source: evolution of the design](#)
W. Królas, A. Ibarra, F. Arbeiter et al.
- [Programme management in IFMIF-DONES](#)
M. García, A. Díez, A. Zsákai et al.
- [Logistics and maintenance: current status in the IFMIF DONES project](#)
F. Arranz, J. Chiachio, J.A. Garrido et al.

Remote maintenance in IFMIF-DONES: current status and future development program

G. Micciché^{1,*}, F. Arranz² , M. Mittwollen³, M. Mallouli⁴, V. Redondo⁵, M. Ferre⁵ , J. Garrido⁶, K. Varga⁶, M. Rouret⁶, E. Valenzuela⁶ , F. Barranco⁶ , A. Cano⁶, A. Cammi⁷, G. Benzoni⁷, C. Tripodo⁷, Y. Wang³, A. Zsákai⁸ , T. Dezsi⁹, T. Tonci¹⁰, M. Hoic¹⁰, M. Siuko¹¹, K. Raino¹¹, G. Mitchell¹² and E. Chris¹²

¹ ENEA, Department of Fusion and Nuclear Safety Technology, C.R. Brasimone, Camugnano, Italy

² CIEMAT, Madrid, Spain

³ Karlsruhe Institute of Technology (KIT), Karlsruhe, Germany

⁴ IDOM Consulting, Barcelona, Spain

⁵ Universidad Politécnica de Madrid, Centre for Automation and Robotics, Madrid, Spain

⁶ Department of Computer Engineering, Automation and Robotic, University of Granada, Granada, Spain

⁷ Politecnico di Milano, Department of Energy, Nuclear Engineering Division, Milan, Italy

⁸ Centre for Energy Research (CER), Hungarian Research Network (HUN-REN), Budapest, Hungary

⁹ C3D Engineering Consultant Ltd, Budapest, Hungary

¹⁰ Ruder Boskovic Institute, Zagreb, Croatia

¹¹ VTT Technical Research Centre of Finland, Tampere, Finland

¹² RACE, UKAEA, Culham Science Centre, Abingdon OX14 3DB, United Kingdom of Great Britain and Northern Ireland

E-mail: gioacchino.micciche@enea.it

Received 14 October 2024, revised 4 April 2025

Accepted for publication 23 April 2025

Published 24 September 2025



CrossMark

Abstract

The International Fusion Materials Irradiation Facility—DEMO Oriented Neutron Source (IFMIF-DONES) is a facility currently being built in Granada (Spain). It is an accelerator-driven intense neutron source designed for the study and qualification of structural materials under severe irradiation conditions of a neutron field with an energy spectrum similar to the one present in a fusion power reactor. IFMIF-DONES consists of complex systems and massive components that need to be assembled and maintained on site. For several of them, it is required to perform maintenance, inspection and monitoring tasks over many years in a hostile environment and in an efficient, safe, and reliable manner. The maintenance of IFMIF-DONES systems and components, located mainly in the Test Systems, Lithium Systems, and Accelerator Systems, is classified as a remote handling (RH) 1st class activity. Over the last 5 years, much progress has been made in the definition of the maintenance activities to be performed for such a facility. The main achievements include: the definition of the RH maintenance requirements; implementation of the maintenance strategy; classification of components from the maintenance point of view; the development of the maintenance procedures and the design of the RH system (RHS). This

* Author to whom any correspondence should be addressed.



Original content from this work may be used under the terms of the [Creative Commons Attribution 4.0 licence](https://creativecommons.org/licenses/by/4.0/). Any further distribution of this work must maintain attribution to the author(s) and the title of the work, journal citation and DOI.

latter system comprises the whole set of RH equipment and tooling for the execution of the maintenance tasks. In addition, a wide experimental program is ongoing to validate the RH maintenance operations and the custom and special purpose devices used to implement them. In this paper, an overview of the present status of the IFMIF-DONES RHS design is given together with a description of the validation activities, either underway or planned in the next coming years, for the RH maintenance of various systems and components of the facility.

Keywords: IFMIF-DONES, maintenance, remote handling maintenance

(Some figures may appear in colour only in the online journal)

1. Introduction

The International Fusion Materials Irradiation Facility—DEMO Oriented Neutron Source (IFMIF-DONES, from here on referred to as DONES) is a facility that is under construction in Granada (Spain), planned as part of the European fusion-generated electricity roadmap. It is designed to study and qualify structural materials under severe irradiation conditions of a neutron field with an energy spectrum similar to the one present in the first wall of DEMO. To reach the expected irradiation condition of materials, DONES should be operated as intensively as possible to enhance and maximize the radiation damage produced yearly. According to this, each system of DONES is designed to guarantee an availability of more than 90% to achieve the goal of an overall availability of 70% of the plant, [1]. However, systems and components are subjected to degradation and require to be monitored, inspected, and maintained to function as per design. In DONES, there are several components [2] whose maintenance is considered critical, which can compromise the plant's regular functioning. These maintenance operations will be carried out by means of remote handling (RH) procedures using the RH system (RHS) developed for IFMIF-DONES.

This paper deals with the RHS design status, the RH maintenance needs in DONES, and the validation activities status. Therefore, this paper following sections provide an overview of the RHS and maintenance processes for the Test System (TS) (section 3), for the Accelerator System (AS) (section 4), and for the Lithium System (LS) (section 5). Then the RH control system is presented (section 6) along with the Viewing System (VS) (section 7). Finally, the results of the RH validation activities supporting the design of DONES components and technologies are provided in section 8.

2. The RHS of IFMIF-DONES

The DONES RHS is a man-in-the-loop system for performing remote maintenance tasks on the machine and machine components, and it is operated from the dedicated RH control room (RHCR). The DONES RHS covers all areas of the plant where maintenance is required, the AS, the TS, and the LS. The RHS is then managed by a control system and requires a VS for operator monitoring and operation.

The RHS then consists of the following subsystems t[3]:

- RHS of the LSs: devoted to the maintenance of the Li loop and the Li purification components, such as the target assembly (TAA), the dump tank (DT), and the hot and cold traps;
- RHS of the TSs: devoted to the maintenance of the Test Cell (TC) internal components, such as the High Flux Test Module (HFTM) and the plugs to close the TC itself;
- RHS for the ASs: devoted to the maintenance of the beam dump (BD), the scraper, the modules in the Target Interface Room (TIR), and of the Radiation Isolation Room (RIR) components;
- VS: devoted to supporting the RH operators during the maintenance operations;
- RH control system: devoted to managing, monitoring, and executing maintenance operations by using an integrated environment consisting of human machine interfaces (HMIs), virtual reality, and camera systems.

The RHS has been designed based on the DONES plant design requirements and to satisfy several principles to ensure its effectiveness in performing all maintenance tasks within the expected time allocated for the yearly RH preventive maintenance [1]. Among the RH design requirements of the RHS, the one having major impact in terms of its effectiveness, there is its capability to perform parallel operations in all maintenance areas of DONES, and inside of each area as well. A complete set of design requirements of the RHS is already defined and it is kept constantly updated taking into account the design evolution of the DONES' systems. The RHS also will include equipment and tooling for the execution of maintenance tasks in case of failure scenarios and the recovery of the systems. Furthermore, the RH needs also influence the development of DONES components leading to using custom and one-of-a-kind designs that requires thorough validation before adoption in the facility.

2.1. Maintenance needs in IFMIF-DONES

Several DONES components require regular and scheduled maintenance and replacement in case of failure. However, due to the neutron activation of the components, the environment

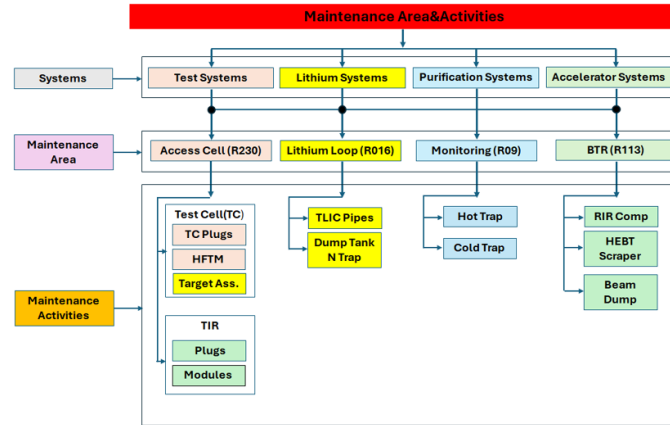

Figure 1. High level maintenance activities of DONES system. Reprinted from [3], Copyright (2019), with permission from Elsevier.

is extremely radioactive, and therefore the maintenance operations must be performed using the RH approach. Based on the criteria defined by the DONES project, hands-on maintenance is assumed free for areas below $10 \mu\text{Sv h}^{-1}$, and RH is directly required for areas above 100mSv h^{-1} . The areas with moderate doses of $10 \mu\text{Sv h}^{-1}$ – 100mSv h^{-1} are subjected to as low as reasonably achievable (ALARA) evaluation to reduce occupational radiation exposures [4]. The maintenance for the areas with expected doses higher than 100mSv h^{-1} operations will be carried out exclusively using RH. All components, which need to be remotely maintained, have been identified and classified according to the classification adopted in ITER [3, 5]. These components are located in different areas of the plant: the TC, the lithium loop, the purification loop, and the Beam Transport Room (BTR). Figure 1 shows the high-level RH maintenance for DONES classifying the activities according to the areas of the facility.

Most of these components belong to the first class of the RH components classification except a few, such as the cartridge and the cold traps, that are designed for the lifetime of the facility and thus maintained only in case of failure. Among the maintenance areas of DONES, the Access Cell (AC) covers almost all (i.e. 90%) of the yearly preventive RH maintenance. This is because, from the AC, the maintenance of the TAA, the HFTM and the modules in the TIR will be performed [3]. Furthermore, critical preliminary operations will be carried out during maintenance time to give access to these components, which are located in the TC, the facility's most activated area (see CH# 4 for reference).

3. The RHS and the maintenance processes for the TS components and systems

3.1. TS overview

The TS is one of the key systems inside DONES, which includes the TC, where, at the Target, the neutron beam is produced, which then penetrate the HFTM to irradiate the material specimens [1, 3]. Figure 2 shows a section view of the TC illustrating all of the components (besides HFTM and the TAA) that have to be handled by the TS RHS. The TC is designed to

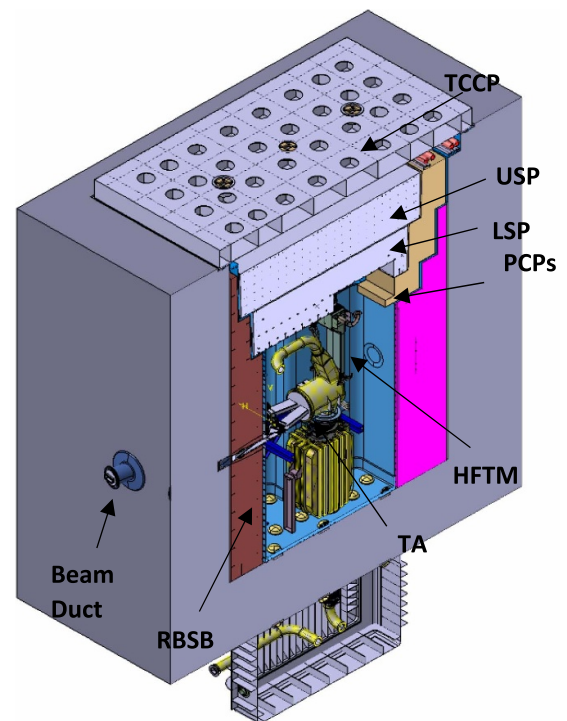

Figure 2. Section view of the TC. Reproduced from [6]. CC BY 4.0.

be fully maintainable [6]. This means that apart of the bucket, the grey part in the picture, that is permanent, all other components are designed to be replaceable. In details, the TC consists of components belonging to the 3rd class of components (e.g. designed for the life time of DONES), such as the removable biological shielding blocks (RBSBs), the steel liner that represents the first safety protection barrier and of the plugs that close the TC in the upper part: the upper shield plug (USP) and the lower shielding plug (LSP). All cables and the cooling systems for the HFTM are feedthrough the piping and cables plugs (PCPs). The TC is finally hermetically closed on the top by means of the TC cover plate (TCCP) and the sealing system. This latter system allows to keep the 50 KPa of He pressure inside the TC.

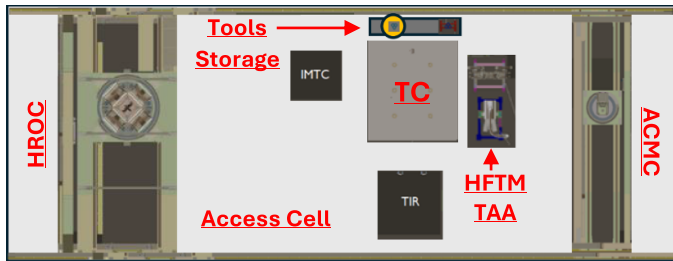

Figure 3. Top view of the AC at the maintenance time.

The TC is the most activated area of DONES plant [4] and requires a big effort in terms of maintenance of its components that must be performed via RH.

The scheduled maintenance operations to be performed in the TS are then the following: the opening and closing the TC, the replacement of the HFTM, the inspection of the TC, and the transportation of irradiated components to/from the Irradiating Material Treatment Cell (IMTC). Instead, the components that require corrective maintenance from the TS RHS in the unlikely case of their failure are the following: the PCPs, the TC liner, and the RBSBs.

3.2. The RHS of the TS maintenance

The RHS of the TS is located in the AC and consists of two main cranes and several tools and end effectors [3]. It should be pointed out that a few equipment and end effectors of the RHS of the TS are common to those of the RHS of the LS and of the AS. These equipment will be described only in this section. The AC, as main maintenance area, is sized to temporarily store all the TC removable components, like the TCCP, the USP and the LSP while the TC is opened. Furthermore, the AC is designed to also accommodate the shielding plugs for the TIR and the IMTC. Finally, the ‘fresh’ components, i.e. unirradiated HFTM, are stored inside the AC prior to installation in the TC. A general view of the AC layout during maintenance is given in figure 3.

The RHS in the TS is designed on the basis of several general requirements which must be fulfilled to not compromise the overall availability of DONES. Therefore, all the remote maintenance processes have to be planned and performed in an optimal sequence to provide an availability of the TS of 90% to reach an overall plant availability of 70% [3]. The RHS of the TS is dedicated to perform all the maintenance work in the AC and especially in and around the TC, which covers approximately 90% of all preventive RH work of IFMIF-DONES. Indeed, the AC RHS will perform the maintenance of the TC, of the TAA, the HFTM and the modules in the TIR that belong to the AS [7]. Furthermore, the RHS of the TS is designed for the handling of heavy and massive components with a weight of up to 120 tons, such as the TC shielding and TIR plugs. In figure 4 the two main RHE of DONES TS RHS, the Heavy Rope Overhead Crane (HROC) and the Access Cell Mast Crane (ACMC) [3], are shown.

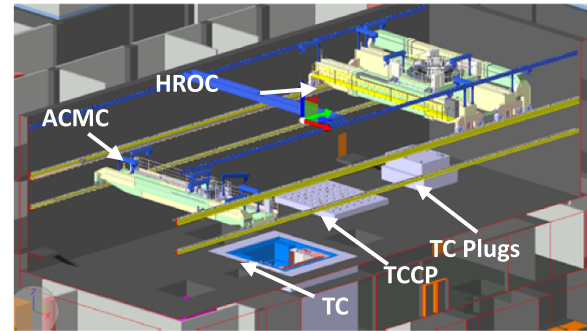

Figure 4. View of the AC and cranes for TC maintenance.

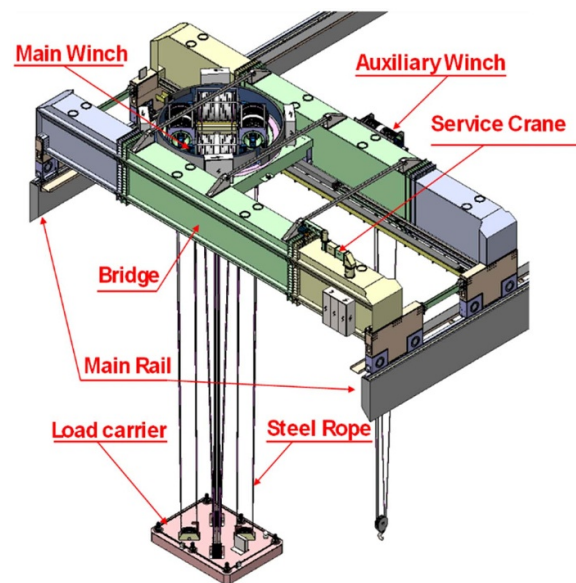

Figure 5. View of the 3D model of the HROC.

The HROC is a multi-rope double beam overhead crane, designed to lift and transfer any large and heavy components of the TC, such as TCCP, USP and LSP, requiring moderate positioning accuracy. As of today, the crane has reached its final engineering design having a maximum working load of 140 tons, with an auxiliary hoist with 15 tons lifting capability to move other lighter components as well as help lifting and supporting of some irregular pieces. The crane has 6 DOF including rotation around the vertical axis (X , Y , Z , RX , RY , RZ) with maximum translational speed of 50 mm s^{-1} and maximum rotational speed of 2° s^{-1} . A 3D model of the HROC is shown in figure 5.

In addition to the Cartesian translational axes, the HROC is designed to have the capability of inclining the components hanging under its plate in any directions in the space.

More in detail, the synchronized lifting and lowering of all ropes at the same time lifts the plate and the load only in the Z direction, while the differential lifting and lowering of the ropes gives the rotation along the horizontal axes RX and RY . The additional rotational vertical axis (RZ) allows to

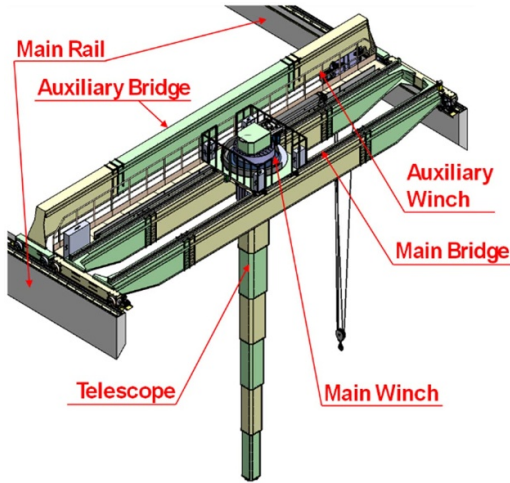

Figure 6. Final engineering design of the ACMC.

Table 1. Main ACMC work parameters.

Parameter	Values
Telescope max load	3, 25 t
Telescope fully extended	16, 30 m
Maximum rotation angle	360°
DOF for telescopic mast	4 (X, Y, Z, RZ)
Speed (min—max) X, Y axes	0.1/20 m min ⁻¹
Speed (min—max) Z axis	0.05/10 m min ⁻¹
Speed (min—max) RX axis	0.2/2° s ⁻¹
Repeatability X, Y, Z	±10 mm
Repeatability RZ	±1°

place the component with the desired position. The detailed engineering design of the HROC is done by the Faculty of Mechanical engineering of the University of Zagreb. The HROC is designed to have a maximum accuracy of 5 mm on the X and Y plane, while of 1 mm on the Z plane. Besides the rotational accuracy around the axes (RX, RY, RZ) is foreseen to be of 1°.

The ACMC [3] is a specialized crane dedicated to the RH maintenance operations inside the TC and the TIR. The ACMC is a nuclear grade double beam overhead crane equipped with a vertical telescopic boom. At the lower end of the telescopic mast a gripper change system (GCS) is installed allowing the use of several different RHE [3], the parallel kinematic manipulator (PKM) [8], the robotic arm (RA) that then host the specific tool needed for the maintenance or the lift frame for the TAA replacement.

The design also includes an auxiliary winch with payload up to 6 tons. In figure 6 the final engineering design of the ACMC is shown which is produced by the University of Zagreb as ongoing task. The main design Characteristics of the ACMC are included in the next table 1.

The ACMC telescopic boom is designed to transmit all the necessary electrical and pneumatic signals through the GCS to the end effectors. A view of the present design of the

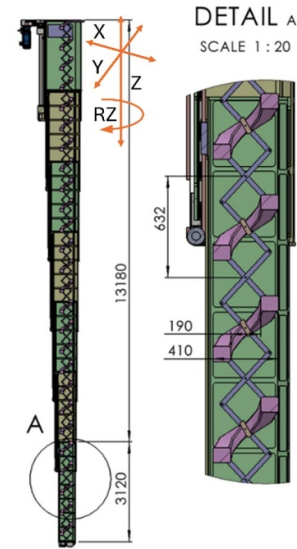

Figure 7. Fully extended boom and cables management.

cable management inside of the telescopic boom is shown in figure 7.

An alternative cable management system is currently under investigation with the scope to reduce the number of cables within the telescopic boom. The investigation is addressing the possibility to use a MUX (Multiplexor) technology and the compatibility to radiation of the existing off-the-shelf MUX systems. Finally, the telescopic boom is designed to reach the bottom of the TC to perform rescue tasks.

The PKM [8] is based on a standard (albeit inverted) 6 DOF Stewart platform configuration: the upper plate is rigidly connected with the ACMC boom while the lower plate is connected to the upper one with six linear actuators. It is designed to have 2 t of payload capability. The PKM kinematic structure allows the precise positioning of the TAA or the HFTM required in the limited TC space without the need for a repositioning of the crane. Furthermore, the PKM structure allows to move and tilt the tools connected to the PKM lower plate such as the TAA Gripper (a lifting/positioning frame for TAA installation and removal) or the HFTM adaptor. A picture of the PKM designed is shown in figure 8. The PKM, similarly to the ACMC, transmit the electrical and pneumatic signals to the end effector on the lower plates of the GCS via an internal umbilical (not represented in the 3D model).

The PKM is designed to be self-recoverable and it shall include redundant sensors and actuators to comply with the single-failure criterion. According to this, a 7th backup redundant actuated leg, identical to the other six, which remains unactuated during normal operation (i.e. it is passively back-driven when the platform moves) has been introduced. This redundant PKM design is the typical solution employed to guarantee fault-tolerance to mission-critical PKMs.

The RA [3] can perform delicate RH maintenance operations on components in the TC. The system is designed to have 7 DOF and to be mounted on the ACMC telescopic boom. The

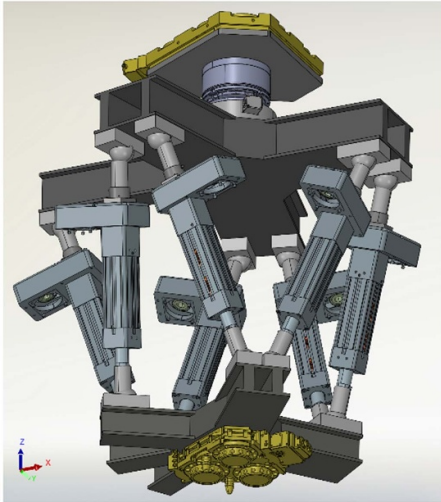

Figure 8. 3D view of the PKM design. Reprinted from [8], Copyright (2022), with permission from Elsevier.

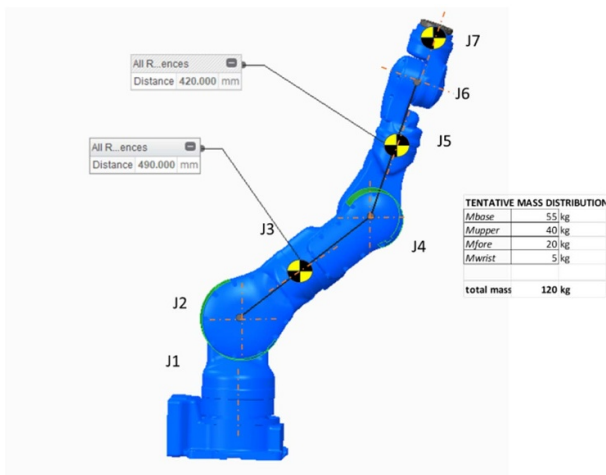

Figure 9. Preliminary design of the RA.

RA will then equip different tools and end-effectors to perform the maintenance operations in the TC. Furthermore, the RA can also perform transport tasks of light components. The design uses as reference on MOTOMAN SIA20D/SIA20 F from Yaskawa®. The preliminary design was done by ENEA, while the detailed engineering design will be in charge of industry. A picture of the preliminary design of the RA is shown in figure 9, reporting also some preliminary details. Similarly to the PKM and the ACMC also the RA needs to deliver all the signals to the end-effectors connected to the gripper (via the GCS) without any exposed cable similarly to the Staubli RA designs (like the TX2-90).

One further important RHE is the HFTM-adaptor, for coupling the HFTM to the PKM, a lifting/positioning frame for HFTM installation and removal. This component is connected to the PKM via the GCS and enable the replacement of the HFTM. The system provides safe and reliable

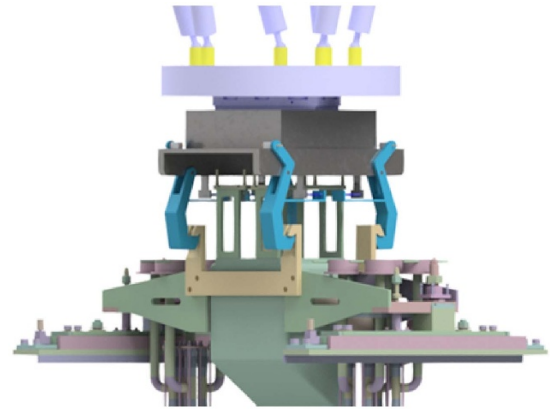

Figure 10. HFTM-adaptor. Reproduced from [9], with permission from Springer Nature.

connection between the HFTM and the ACMC during the lifting, transportation and positioning of the HFTM. The adaptor is designed by Universidad Politécnica de Madrid (UPM) (ES) and is shown in figure 10 [9].

3.3. The maintenance process for the TS

The maintenance of the TS involves the opening and closing of the TC, the inspection of the TC, the replacement of the HFTM and the transportation to and from the IMTC, and the Post Maintenance Acceptance Tests (PMATs) on the HFTM. These maintenance operations are composed of several sub-tasks that the RHS needs to fulfill during the TS maintenance. For example, before the start of the maintenance a set of conditions and requirements must be met, called ‘preconditions’, which depends on the system. In the case of the TC components the set of preconditions imposes that the operations to turn off the beam have been completed, that the RHS is ready and operational, and that the area preparation (i.e. delivery of new components) is completed. Once the preconditions are all satisfied, the TS RH maintenance can be initiated. Then, after the completion of the TS maintenance, the PMAT tests are performed to assess if the system is ready to operate in DONES so that if the outcome is negative, corrective actions must be implemented. The first step in the TS maintenance involves all the operations necessary for the opening of the TC, a process that requires the intervention of both the ACMC and of the HROC. The HROC first removes the TCCP and then the USP and the LSP as shown in figure 11, while the ACMC, in this phase, is used only to detach the cooling pipes of the LSP.

After the completion of the TC opening operations, the area is inspected before proceeding with the replacement of the HFTM. Then, the ACMC releases and removes the HFTM ancillary system such as signals and cooling lines. After the ancillary systems have been removed from TC the ACMC detaches the HFTM from the supports, equips the PKM and the adaptor, and then retrieves the HFTM from the TC. Next, the ACMC releases the TAA module and lifts it from the

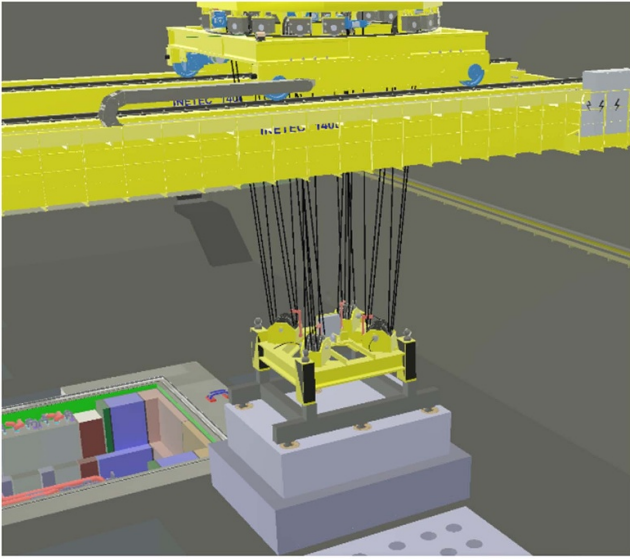

Figure 11. VR simulation view of the HROC removing the LSP.

TC to install a new one along with the TAA ancillary systems. After the TAA installation and the successful outcome of the PMATs, either a new or used HFTM (if a second irradiation cycle is foreseen) is then positioned inside the TC. Once the HFTM is positioned, the ancillaries are installed and the PMATs are successful, a final inspection is carried out and if the outcome is positive, the operations to close the TC start. Figure 12 shows the flowchart of the HFTM removal operation. In the figure the procedures to replace the HFTM ancillary systems, the electrical connector (EC) bridge and the cooling pipes, are represented as ‘external’ subsets of the overall procedure. Finally, after the completion of the PMATs to the TC components, the closing operations start where all the shielding blocks and the connections are reinstalled.

In figure 13 a screenshot of the simulation of the removal operation for the HFTM is shown.

The RH maintenance process for the TC components in general has been defined and preliminary assessment on its feasibility has been performed. As for the HFTM simulation of the maintenance procedures has been carried out through virtual reality simulation. This latter activity proved the feasibility of the maintenance operation as well as the kinematics of the designed RHE and the effectiveness of the implemented RHS for the TS.

4. The RHS and the maintenance processes for the AS components and systems

4.1. Overview on the AS

In the accelerator, the deuterons are taken up to the energy level of 40 MeV before interacting with the liquid lithium target. Indeed, due to the high energy of the beam the AS also requires

RH. More in detail, RH maintenance is required in the high energy beam transport (HEBT) line scraper [10], the BD, the TIR, and in the RIR. The AS components in the accelerator vault that require RH and the corresponding RHS are reported in figure 14 [1, 3, 11]. Not indicated in the figure is the TIR, housed in the AC.

The HEBT is then equipped with a scraper that has the function to remove the halo of the beam to reduce the losses downstream, preventing activation of diagnostics, magnets, and vacuum equipment. The HEBT scraper, see figure 15, is located inside a shielding structure, and housed in a support suitable for RH with a GCS on top.

The RIR is also part of the HEBT line and is composed of the last accelerator modules located in the accelerator vault. The RIR gathers diagnostics devices such as beam profile chamber and beam position monitor, vacuum components, and a safety system composed of a lead shutter chamber. The RIR systems are grouped in a module equipped with a GCS to enable replacement similarly to the HEBT scraper.

The BD [13] is a cone made of copper with a shielding made by layers of polyethylene, lead, and iron that will be used when commissioning the accelerator. The BD has been designed by IREC(ES), and it is based on the design of the one used in the linear IFMIF prototype accelerator (LIPAc) but with several modifications both in the shielding [13] and the cartridge [14]. The BD is equipped with two mobile carts that open the shielding revealing the cartridge. The replacement process of the BD cartridge follows the same steps of the HEBT scraper. A picture of the BD is shown in figure 16 [13].

The TIR is an AS subsystem housed in the AC and is composed of several modules for monitoring and controlling the beam before hitting the lithium target in the TAA. Due to the location in the AC, the maintenance of the TIR is performed by the ACMC and the HROC, along with a specialized system called Deployable Robotic System (DEROSY). The AS RH maintenance regions can then be subdivided into two main ones: the BTR region and the TIR region according to the location in DONES. In particular, the BTR region RHS covers the maintenance of the HEBT scraper, the BD, and the RIR modules. The operations in the TIR region are instead limited to the maintenance of the TIR modules.

4.2. The RHS of the BTR region

The BD area is serviced using two cranes based on the same design: the Accelerator Mast Crane South (AMCS), used for the maintenance of the BD, and the Accelerator Mast Crane North (AMCN) that instead maintains the HEBT Scraper and of the RIR modules [15]. Both cranes have been designed by Ansaldo S.P.A.(It). An illustration of the AMCN and of the AMCS in the AS is given in figure 17. Furthermore, the figure shows a CAD view of the BD region indicating also the HEBT, the RIR modules and the BD.

The AMCN/S have a maximum payload of 3.2 t and 4 DOF enabling translation on the X, Y, and Z axis and rotations on the

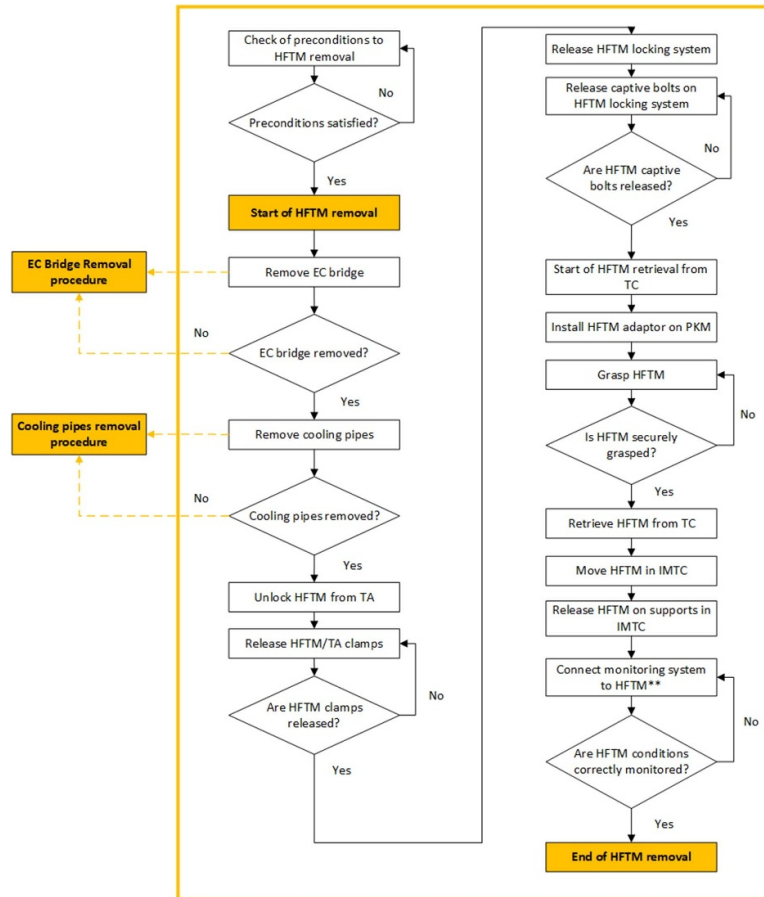

Figure 12. Removal operations of the HFTM—flow chart.

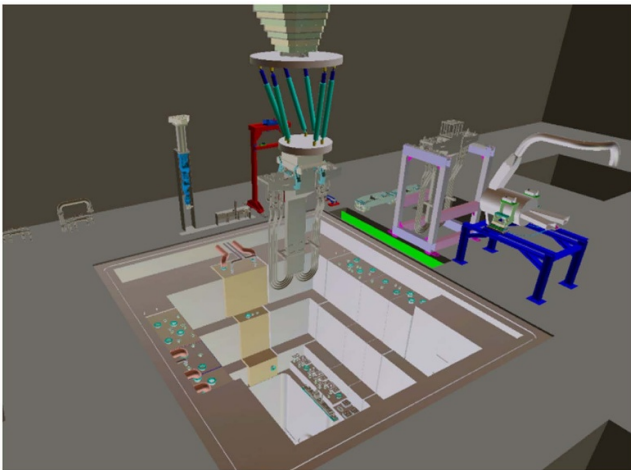

Figure 13. Overview of the HFTM removal operation.

Z axis (RZ). The design of the system includes the following items:

- a main bridge providing structural support and integrity;
- carriage with rotation around the vertical axis, allowing 180° rotation towards each side;

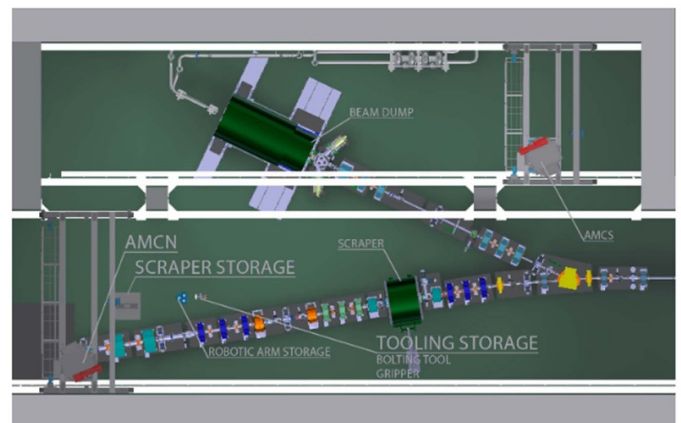

Figure 14. Elements of the AS requiring remote handling.

- a telescopic mast controlling the ascent and descent of the GCS at the bottom of the mast that then connects to the different RHE and to the AS components;
- a chain drive hoist to provide auxiliary function for hands on operations;
- end carriages providing movement along the rails;
- an access platform granting safe access during installation and maintenance activities;
- civil structure providing support to DONES structure.

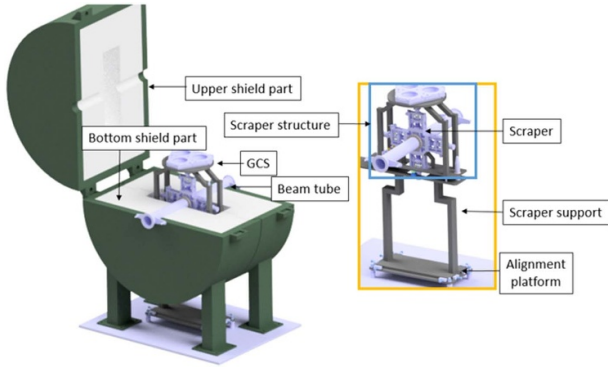

Figure 15. Structure of the HEBT scraper [10, 12].

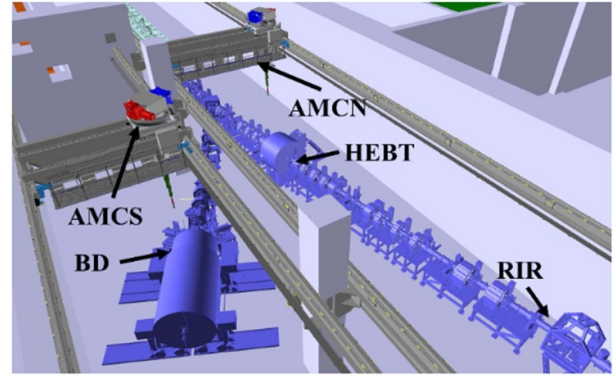

Figure 17. Accelerator vault RHE in the BD region [3, 15].

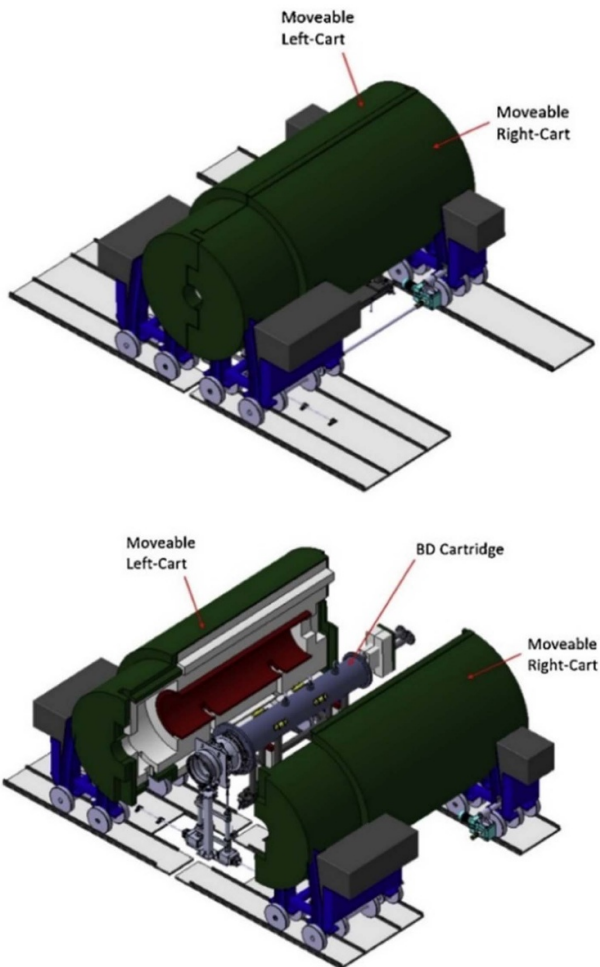

Figure 16. BD module structure. Reprinted from [13], Copyright (2020), with permission from Elsevier.

Figure 18 shows the 3D CAD view of the AMCN/S showing the different subsystems.

The RHS in the BTR includes also a RA, similar to the one used in the TS, and tools for inspection and screwing/unscrewing operations.

The maintenance process of the BD, HEBT scraper, and of the RIR are similar and involve the opening/closing of the shielding, the release/lock of the connections with the beam

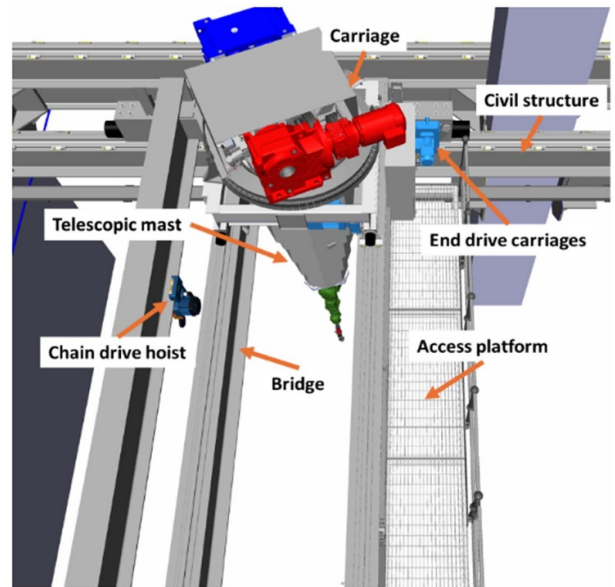

Figure 18. AMCS/N design identifying each subsystem.

lines, and the replacement of the component. Furthermore, once a new component is installed, it needs to be aligned with the rest of the AS to ensure correct beam trajectory [16]. As example, figure 19 shows the VR simulation of the BD maintenance, where the new cartridge is lifted from the transport and installed in the opened shielding. Then, once that the cartridge has been fixed in position, the BD shield is closed by moving the two carts. The process is similar for the HEBT scraper, when the HEBT scraper module needs to be replaced, the shielding is first opened and the scraper connected to the crane via a GCS [3, 10, 12, 16]. Once that the connection is secured the crane lifts the scraper and takes it to the storage position. Finally, a new HEBT scraper module is installed, aligned, and secured in the shielding.

4.3. TIR region maintenance

The TIR room contains four accelerator modules, that monitor and control the beam before hitting the lithium target [12]. Due to the vicinity with the TAA, severe levels of activation are expected in the TIR requiring RH maintenance. Therefore, to

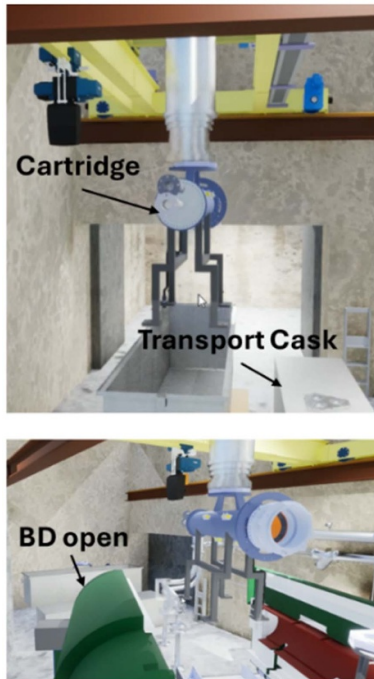

Figure 19. VR view of the BD installation process [17].

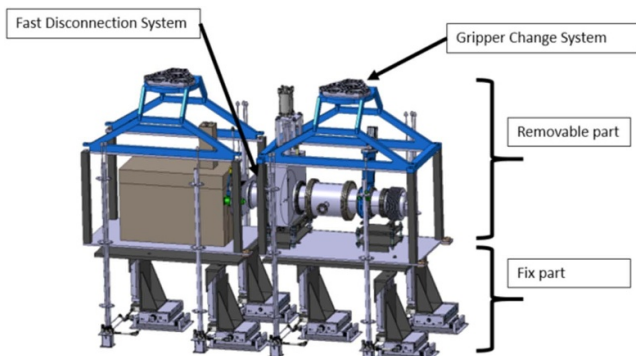

Figure 20. Modules 3 and 4 of the secondary line in TIR.

enable RH maintenance, the connection among the modules is done via fast disconnection systems (FDSs) [18]. Then, each of the modules includes a GCS on top to be grasped by the ACMC. An example of the TIR modules is shown in figure 20 (For TIR modules 3 and 4).

The TIR modules are composed of a removable and of a fixed part. Before a module is removed, it is disconnected by operating the bolts of the FDS to then retract the flexible bellow that connects the two modules. Then the boom of the ACMC is connected with the GCS and lifts the removable section of the TIR module. Once a new removable part is installed, the fixed part can be used to adjust the alignment with the beam line using several bolts extended to the top of the modules. The bolts then act on sliding tables used for adjusting the position of the modules. The TIR modules replacement

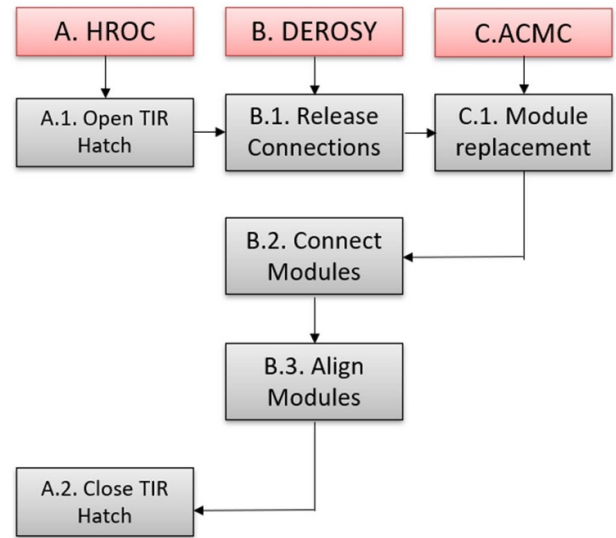

Figure 21. Flowchart for TIR module replacement.

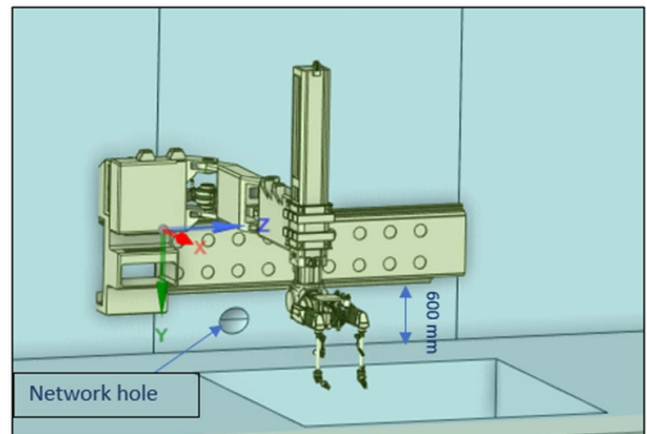

Figure 22. DEROSY positioning in the AC.

process is summarized in figure 21 showing also which RH equipment perform the operation.

One purpose-designed RHS for the maintenance of the TIR is the DEROSY whose main function is to perform precise operations, such as detaching connectors or handling bolting tools using a twin manipulator design. Initially defined by UKAEA, the DEROSY consists of a set of rails fixed to the wall, over which a carriage moves linearly equipped with a horizontal boom and a vertical mast connected to a pair of twin manipulators. Figure 22 shows a preliminary view of DEROSY inside of the AC, while figure 23 shows a closeup view of the servo manipulator.

It should be pointed out that also other configurations are being evaluated by the designers to assess the potential use of a serial manipulator instead of the twin one. This is because the TIR area will be quite crowded of cables and pipes and the use of a twin manipulator, despite recommended, could not be possible in a few phases of the maintenance.

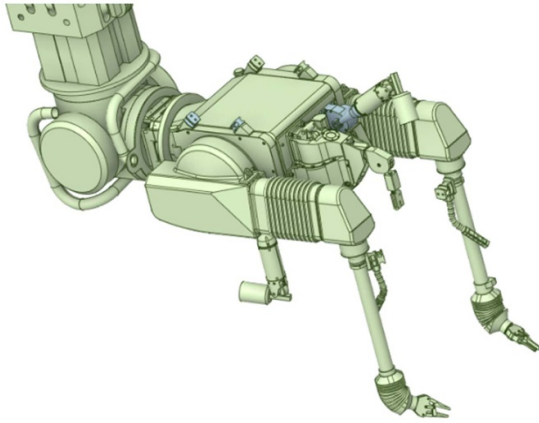

Figure 23. DEROSY servo manipulator.

The DEROSY is composed of a horizontal articulated boom that allows the system to cover the entire area of the TIR in the horizontal plane. Then, the telescopic mast extends vertically into the TIR giving the system the ability to move along the vertical axis. Finally, the servo-manipulator mounted at the bottom of the mast carriage performs the operations. The twin manipulator uses a 6 DOF design and a maximum payload of 20–25 kg driven by a master-slave controller. The engineering development of this equipment is in the early stage of the design being carried out by IDOM (ES). A thorough analysis of the requirements was done including: functional, technical, control elements and accessories, radiation hardness and structural. In addition, a kinematic analysis has been done providing insight of the reachable areas inside TIR.

4.4. Future developments in the RH of the AS

The RH equipment and procedures have reached the target state of development defined at project level and in some cases even more. That is the case of the cranes in the accelerator vault which is succinctly explained in section 4.2. Future developments should focus on the engineering design of the tooling and the DEROSY system, supported by analysis done with virtual reality simulations. Some particular topics of interest for future research activities would be the development of connections for electrical signals and cooling fluids as well as vacuum connections.

5. The RHS and the maintenance processes for the LS components and systems

5.1. Overview of the LS

The main function of the LSs is to provide a suitable neutron flux for the irradiation of the materials of interest. Therefore, activation of materials due to neutrons and presence of lithium deposited all around the Li loop, even when the loop is drained, lead to most of the components inside the LS are classified as RH 1st and 2nd class forbidding any human intervention during maintenance. RH activities for the LS are devoted to the maintenance of three main systems, the Target System

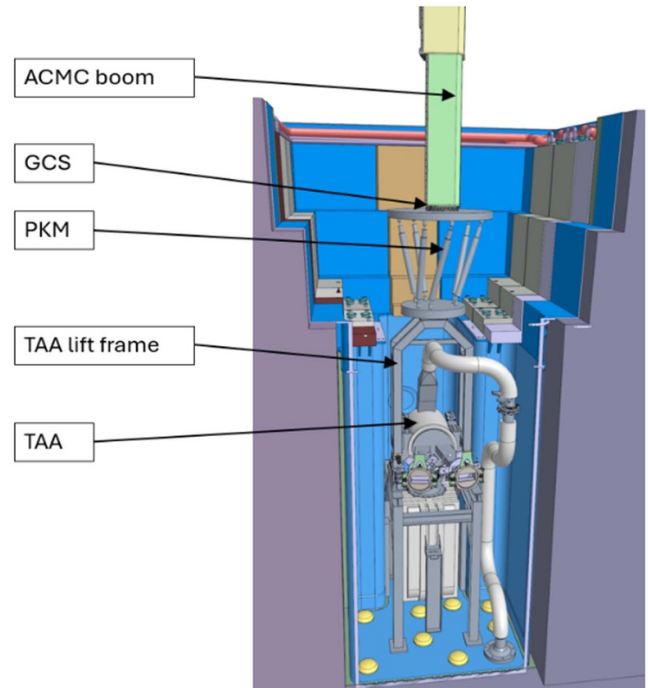

Figure 24. Current design of TAA connected to the ACMC via the PKM.

(TSY), the Heat Removal System (HRS), and of the Impurity and Control System (ICS). More in detail, the TSY consists of the components of the Lithium loop located inside the TC, such as the TAA and the Quench Tank (QTA), the beam ducts (BDs) and the inlet and outlet pipes of the TAA itself [19]. In addition, ancillaries' components and devices such as thermal insulations, heating systems, electric connectors are also parts of these components requiring RH maintenance activities. The HRS includes the main Li loop and the DT, re-circulating the lithium between the Target System and the primary heat exchanger (PHX). The ICS consists of a branch line to the main Li loop, which extracts a fraction of the lithium and re-injects it after purification and impurity analysis. Moreover, the Test Cell Lithium Loop Interface Cell (TLIC), which is the interface between the heat removable system and TSY, will be remotely maintained during the annual preventive maintenance period [20].

5.2. The RHS for LS maintenance

In order to perform the maintenance of LS components, several RHE and RH tools have been proposed and verified during the last years. For the replacement of the TAA, the required RHE and tools have been defined and most of them are common to TS components and installed in the AC. The current design of the TS and the proposed RHE for handling the TAA is shown in figure 24.

One of the most important RHE in the maintenance of the LS is the RA, the same for the TS, which is used to provide dexterous operations and facilitate maintenance and handling of smaller tools. It has 7 axes of movement, and it is assumed

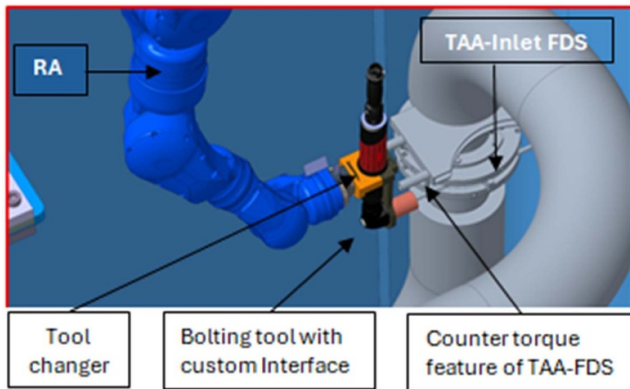

Figure 25. RA and bolting tool in during dismantling of TAA inlet FDS.

that it will have a female plug of the GCS attached to the main body to provide ease of connection/disconnection, which is the same system found in the ACMC. The RA will attach tools remotely via a tool changer. As a preliminary selection a fully mechanical tool changer is proposed by the company Grip®. This mechanism allows connection to the tool (including electrical connection) via following a special trajectory by the RA. The selected general bolting tool is a Desoutter® EAD280-370 (with torque capacity up to 280 Nm). This performance is enough for most of the activities (e.g. connection of BD bellows and FDS, connection of inlet Li pipe FDS, adjustment of TAA, etc). The highest required tightening torque in the whole system is needed to tighten the TAA outlet connection, which is about 400 Nm. Even if there are commercial bolting tools available which can fulfill this requirement, the project currently investigates other methods (e.g. custom designed gearbox operated by small(er) bolting tool or dedicated drive) since properly handling 400 Nm at the end of a RA in such tight environment is not straightforward (e.g. deploying proper counter torque feature). However, even the commercial bolting tools require some degree of customization, e.g. removal of on-board electronics as much as possible, as well as design of proper interface to the tool gripper. Figure 25 shows the RA and bolting tool in TC during dismantling or tightening of inlet FDS of TAA. Comprehensive kinematic analysis have been continuously carried out during the development with the aim of checking the reachability and available space of each location, where the bolting tool must interact with components.

Another area where RH maintenance activities related to LS components have to be carried out is the TLIC. The TLIC is a box like a vessel located on the ceiling of the Lithium room (LLC) accommodating inlet and outlet pipe sections of TSY [20]. It is equipped with two large removable hatches on both sides to give access to the internals, namely FDS connections and pipe segments of the Li pipes.

A number of RHE and tooling have been conceptually conceived for the maintenance operations to be performed. The RHE will be deployed at maintenance time through an

Automatic Ground Vehicle (AGV). Most of the movement of AGV in the building will be programmed, using proper traffic ruling and collision detection/avoidance between the different AGVs moving at the same time in the building.

Since the TLIC is high above the floor, the equipment is mounted on the lifting platform of the AGVs. The equipment can be categorized according to their manipulated components. The equipment and tools for the TLIC include the following: bolting tool and door holder frame to open the TLIC hatches, grippers to handle cables and instruments of TLIC box, and robotic manipulators to operate bolting tools and grippers. Instead, the equipment and tools for TSY components are the following: robotic manipulators to grab and hold components and tools, bolting tool, and grippers (essentially for cable and cable connectors).

Due to the required functionality and payload capacity for servicing the TLIC, the detailed design works resulted in the so-called Smart arm—Strong arm concept. The Smart arm is a commercial 7 DOF RA (with some possible customization, for example local shielding of electronics), pre-selected from Yaskawa. SIA 20D. The function of this RA is to carry out delicate tasks such as bolting and cable handling. The Strong arm is a fully custom designed manipulator with limited number of DOFs but high enough payload capacity and rigidity to handle the pipe segments (weight up to 60 kg). The Strong arm is responsible for holding the pipes in place while the Smart arm untightens the FDS. After that, the Strong arm moves the removed pipe segments to a pipe holder on the lifting platform. A mechanical, automatic tool holder is placed on the platform as well, so the tools for the different operations are quickly available. The failure modes and possibilities of the RH equipment (FMEA Analysis, rescue scenarios etc) have been investigated as well. Figure 26(A) shows RHE for handling the TLIC, while figure 26(B) shows RHE for handling the LS components in the TLIC.

A detailed summary of the main RHE for the servicing of the TLIC, along with a description of the main characteristics is shown in table 2. The table also shows the reference RHE chosen for the LS RHS and if it is available off the shelves or if customization is required.

The other crucial component of the Target System is the QTA. In the current categorization the whole QTA has been categorized as class RH class 3rd which means that it is designed for the lifetime of the facility and is maintained only in case of failure. However, QTA is complex consisting of many parts which have expected lifetime considerably shorter than the plant life. These are the heaters and the instrumentation such as thermocouples, pressure gauges, level meters. There are two ways to handle this: re-classification of the whole QTA for regular maintenance or separate handling of components with shorter lifetime. Indeed, the vessel itself can be designed for a lifetime and can remain as class RH class 3rd. The project currently aims for the second option, namely separate RH management of instruments and heaters. There are numerous activities ongoing to define the proper RH processes and design the necessary RHE and tooling. Naturally most of

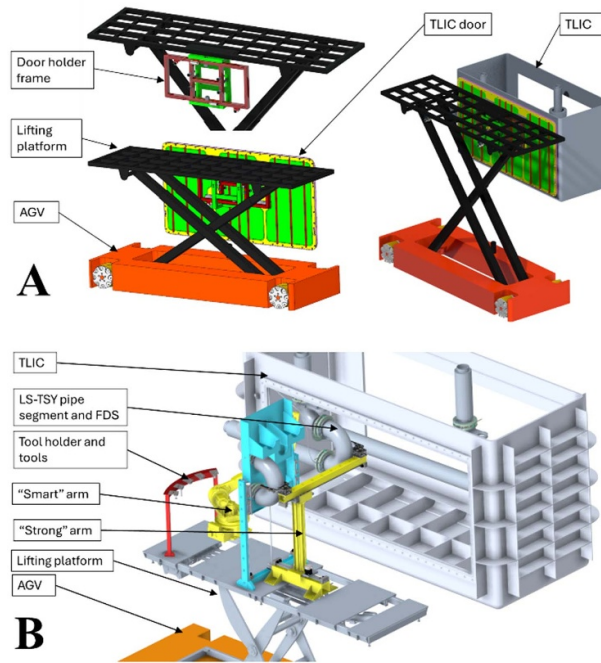

Figure 26. Proposed RHE for (A) handling the TLIC and (B) handling of the LS components inside the TLIC.

Table 2. Summary of main RHE for TLIC maintenance.

Type of RHE	Model	Description
AGV	KuKa UTV-2 series	Payload capacity: 3 t DOF: Omni directional, + platform tilting Accuracy: 3 mm
Lifting platform	Custom designed, possibly from company DeLyft	Payload capacity: 1 t Max. reaching height: 4.5 m
Smart arm	Customized Yaskawa Motoman GP25	Payload capacity max. 25 kg @1730 mm reach Max. reach: 2010 mm Payload capacity at max. reach: 12 kg DOF: 6
Strong arm	Completely custom design	Designed Payload capacity: 70 kg, and 270 Nm concentrated torque on the horizontal arm Max. stroke of horizontal arm: 1400 mm DOF: 2 + gripper
Bolting tool	Customized Desoutter EAD280-370	Max. output torque: 280 Nm
Flange cleaning	Completely custom design	Same as for TAA

the required tools are already available (such as APMC, RA, PKM, bolting tools), but there is a need for development of on purpose equipment such as for example holding frames for heating jackets. As well as further effort is needed from the design side to ensure the manipulability of the different components (e.g. defining the RH compatible separation and fixation method of heating jackets).

There are some further components in LS which require a certain degree of RH maintenance. These are the Li DT, PHX and electromagnetic pump. These components are still actively developed along with their RHE. Also, some kind of RH class de-separation similar to the one currently investigated in case of QTA is possible. For example, the instrumentation and heating jackets can be replaced periodically, while the

vessel/structures could be classified as RH-class 3rd (replacement only in case of failure).

5.3. Maintenance process for the LS components

In the last 5 years, the maintenance process of different LS components requiring RH approach has been defined and updated. The flowchart for TAA removal operations (figure 27) details the process beginning with verifying pre-conditions (the beam off is completed, TC conditioning completed, Li loop is drained). Once the preconditions are satisfied, the removal operation starts by installing a lift frame on the TAA. The next steps involve removing TAA ancillaries and disconnecting it from the beam lines. Subsequently, the TAA

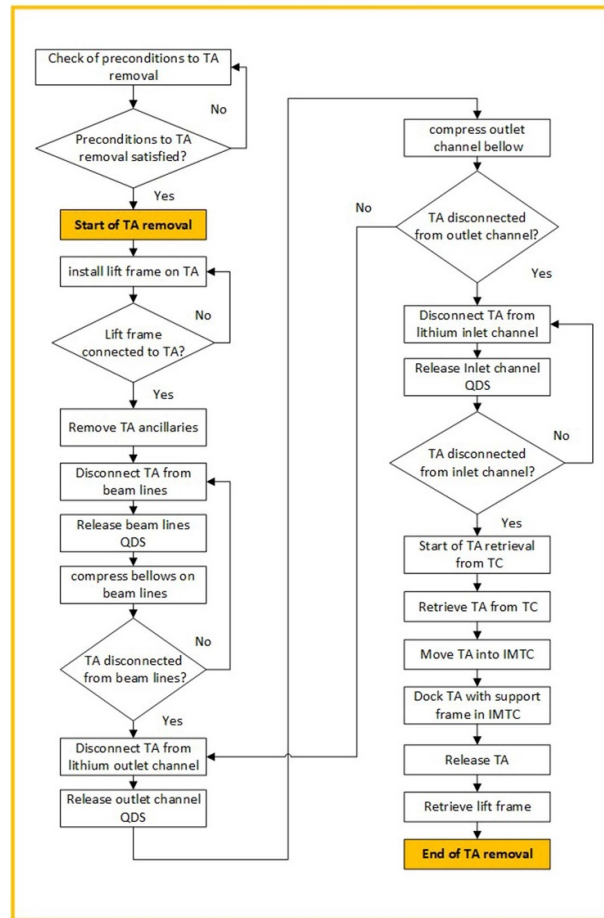

Figure 27. TAA removal operations—flowchart (shortened to just TA in the figure).

Table 3. List of preconditions to LS component RH maintenance.

LS component	Preconditions
TAA	HFTM removed from the TC. The robotic arm is attached to the telescopic mast arm.
TLIC	Movement area of AGV is cleared. AGV's are prepared with the respective configuration (Strong—Smart arm and door holder interface).

is disconnected from the lithium outlet and inlet channels, with bellows compression and FDS release at each stage. The TAA is then retrieved from the TC, moved to the IMTC, docked with a support frame, released, and finally, the lift frame is retrieved, concluding the removal operation. In general, the maintenance process of the LS components consists of several steps as follows: I area maintenance preparation, II inspection activities for ready for maintenance, III perform maintenance tasks (replacement/inspection and repair), and finally IV acceptance tests. The area preparation includes all the activities necessary to prepare for maintenance, such as components delivery to storage locations and RHE functionality checks.

The first actual step in the RH maintenance involves the inspection activities for ready for maintenance. In particular, the general conditions required for starting the maintenance activities inside the LS are, beam shutdown completed, TC conditioning/opening completed, Li loop is drained, and that all the required tools are available on the storage structure in

the AC. Moreover, other specific conditions required to start maintenance of each component have been defined. A list of these conditions is presented in table 3.

Then, once the inspections are completed, the step ‘perform the maintenance tasks to remotely maintain the LS components’ can start. Several RH steps shall be performed that depend mainly on the component design and the needed space for the RHE:

- For the TAA replacement, the following maintenance sequence has been defined, disconnect all electric connectors, disconnect the TAA from the lithium loop, disconnect the two beam ducts, remove the TAA, clean the flanges from lithium solid deposition, inspect the flanges, install a new TAA, and finally carry out the alignment procedure (as reported in [16]) and acceptance tests.
- For TLIC, the main operations to perform are: un-bolt and remove the doors, disconnect cable connections (FDS leak

detectors), remove the old pipe sections and FDSs, cleaning and inspection of the fix pipe flanges, install the new pipe sections and FDSs (no gasket replacement on site), reconnect cable connections (FDS leak detectors), carry out acceptance test with open TLIC, install the new TLIC door (no gasket replacement on site), replace TLIC instrumentation if needed, and finally carry out acceptance tests with closed TLIC. Several maintenance scenarios have been proposed to take into consideration the possible design of the AGV and TLIC doors.

- For the QTA, a preliminary maintenance process has been defined to perform its replacement. During this year, further study on the operation procedure is under investigation.
- For the HRS components, the maintenance strategy is not yet well defined, but the RHE required to carry out maintenance must be capable of performing the following tasks as a minimum: insulation removal/replacement, electrical connect/disconnect, bolt/unbolt connections, cut and weld pipe, position x-ray film, manipulate ultrasonic probe heads, lift equipment and maneuver in the room.

The final step in the RH maintenance requires to execute final acceptance tests: after performing the maintenance operations, acceptance tests should be carried out such as:

- Instrumentation checking of the components (pressure gauge, thermocouple, Li detectors etc.)
- Heating jacket testing using instrumentation (thermocouples).
- Welding inspection and verification.
- FDS lithium leak test.

6. The RH control system

The RH control system is responsible for controlling all the RHS equipment and instrumentation, from the ACMC to the bolting tool and requires real time control by the operator. In IFMIF DONES, the approach followed by the Central Instrumentations and Control System (CICS) is based on the definition of an upper control layer that acts as an orchestrator of the plant subsystems or Local Instrumentation and Control System (LICS) [3, 21]. This approach proposes a centralized control via CODAC and based on a distributed control framework, oriented to scientific instrumentation, massive data collection and execution of automated sequences. These features do not meet the needs of the RHS, which mainly consists of mobile mechatronic devices that must be controlled in real time by a human operator. It is therefore necessary to define an additional control layer within the RH LICS itself, which is responsible for providing these functionalities that the CICS is not able to cover. In particular, the RH control system (RHCS) shall provide: complete control over the RHS from the RHCR, standardized data interface to/from RH devices achieved using the Open Platform Communications (OPC) Unified Architecture (UA), reporting a single Common Operating State (COS) to the CICS while ensuring that each

RH device is able to manage their machine status, to offer manual control switching at any time, visualization of the operations through the VS cameras, management of every operational aspects of RH maintenance campaign on DONES, offline training simulations, force feedbacks on critical operations (e.g. through haptic controllers). Finally, the RHCS shall monitor, supervise, and archive all data relative to RH devices, while each workstation needs to be able to dynamically control any RH device (except the ones with specific interfaces) [3, 21].

In terms of control, two main conceptual groups or types of actions related to control are considered: Operational control and Process control. Operational control is related to the operation of RH devices such as commands, monitoring, or tuning parameters. Process control refers to the procedures and how the RHS coordinates with the rest of the plant. Specifically, it considers the relationship between the plant status and maintenance campaigns, resource allocation, scheduling or the coordination of the systems to be maintained using RH. In addition, the RHCR will also coordinate other aspects such as the task-to-operator assignments, scheduling or the management of spare parts.

6.1. RH control system architecture

It is considered that the CICS will perform coarse-grained control tasks (systems coordination at the plant level), and RH LICS will perform fine-grained control (RH device operation). In addition, the RHCS will comply with the basic architecture proposed for all LICS and replicate the three independent vertical control layers established in the facility (CODAC, MPS and SCS). This results in the control architecture shown in figure 28 [21].

The RHCS has five communication *networks* to interface with the CICS, and internally three additional ones:

- The *RH User Network* connects the workstations from the RHCR to the RH High Level Control System (RH HLCS) modules.
- The *RH Operational Network* connects the RH devices to the RH HLCS modules.
- The *RH Real-Time Network* connects haptic devices and special input devices at the RHCR directly to the RH Devices.

Finally, the RH HLCS consists of the RH Safety and the RH Interlock header Programmable Logic Controllers (PLCs) and 7 additional components:

- **Plant Controller:** it bridges Central CODAC and RH HLCS. In case CICS finally relies on a control framework not based on OPC UA, a gateway will be required to implement the translation between data formats.
- **RH SCADA:** it monitors and controls RH devices by collecting real-time data and providing automated responses. It

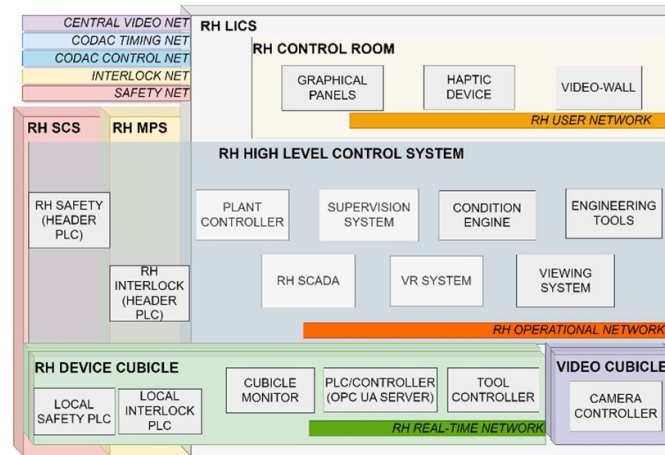

Figure 28. RH control system architecture. Reproduced from [21]. CC BY 4.0.

also implements data archiving and repositories for the HMI panels.

- Supervision system: it monitors the set of procedures followed during RH operations (RH campaigns). It is an advanced Computerized Maintenance Management System that stores the information needed to perform the operations (ideally using a structured language). It also manages resources and spare parts, schedules tasks, and collects logs and acceptance test results.
- VR system: it stores all the VR scenes needed by an operator and offers an interface to the Operational Network through an OPC UA aggregation server. This aggregation server will select the RH device positional values from the Operational Network and it will pass them to the User Network.
- Condition engine: it checks (in real time) multiple conditions that have to be met to operate RH devices such as plant and device status, the supervision system authorization, or collision free paths.
- VS: it provides video and audio digital streams and camera PTZ control. It is connected to the User Network and to the CCR.
- Engineering tools: a set of centralized engineering tools to program, configure and maintain RH device controllers and PLCs.

6.2. OPC UA standard interface

The design considers OPC UA as the standard interface for RH Devices and RH HLCS modules. OPC UA unifies inter-device and device-HLCS communications. There are different scenarios to integrate an OPC UA server into a RH device:

Case 1: The RH device has embedded OPC UA logic

Case 2: The RH device has no built-in OPC UA logic, but it can be accessed remotely. It requires software playing a bridge-like role, capable of connecting to the RH devices, extracting the data, processing it and finally, sending it to the OPC UA server.

Case 3: The RH device has no built-in OPC UA logic and cannot be remotely accessed. It requires a DAQ device (or similar) to probe the electric signals and convert them into digital values. If the DAQ device allows it, the OPC UA server could be also embedded into it. Otherwise, the RH device requires the software described in Case 2.

Currently, significant progress needs to be made in defining the policies, roles and strategies essential for the effective Process control of the RHS. This is crucial since it directly impacts on both, the internal RH LICs and CICS, and is closely tied to the operational states of the plant. Another important topic is the number of operators and engineers foreseen for the facility during its operational life: it is estimated that each shift will need a total of 16 RH operators concurrently working in the RHCR. Considering 8 h rotating shifts, this amounts to 48 operators to ensure continuous operation during maintenance campaigns.

These same operators may also have engineering backgrounds. Having a strong in-house engineering team dedicated to developing, maintaining and updating the RH control system will enable developing a more complex, flexible and feature-rich RHS compared to outsourcing these services to external companies.

Once these critical elements (policies, roles, strategies and workforce requirements) are clearly defined, the comprehensive list of requirements for the RH control system will be complete. This will be the foundation of the technological development phase, ensuring that the system is robust and capable of meeting the operational demands of the plant.

7. The VS

One of the most important components of the RHS is the VS. Indeed, the operator need to continuously monitor the RH operation during DONES maintenance. Due to the strong irradiation field in the areas of the plant that requires RH, the VS needs to employ radiation-resistant cameras. A few

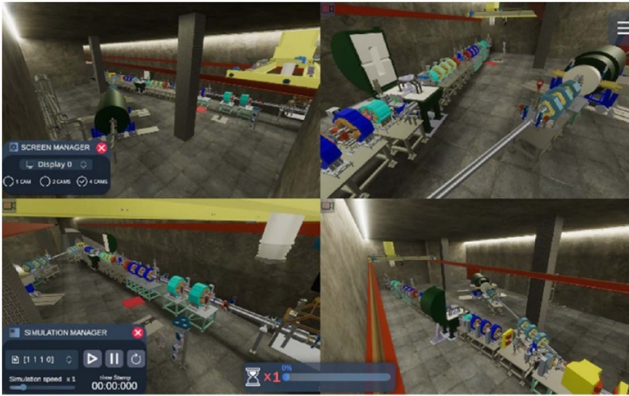

Figure 29. Operator view of the RH operation through the viewing system in VR simulations. Reproduced from [17]. CC BY 4.0.

dozen cameras are needed to comprehensively monitor these maintenance procedures. Most of the cameras are overview cameras, which must have pan-tilt-zoom capabilities, whereas some cameras will be attached to moving parts, and the light weight of these cameras is essential.

Color cameras based on semiconductor technology are available in the market, which can withstand high radiation, some models up to 1 MGy. The price of the cameras is a few tens of thousands of euros, and most camera models have zoom-pan-tilt capabilities, and often lighting. The cameras require supporting parts, including fixed cables (up to 100 m) and camera controllers, which must be placed in radiation-protected spaces.

The most promising camera models to be employed in DONEs were found to be the Ahlberg N35HR (www.ahlbergcameras.com/) and the Mirion Hyperion Compact Gen II cameras (www.mirion.com/). The locations and wiring of the cameras are under development. The work uses Virtual Reality animations, which show maintenance procedures in the DONEs facility model. The characteristics of the cameras of the virtual models (e.g. field of view) were set to be as similar as possible to the characteristics of the prime candidate camera model, and the size (width \times height) of the visualization windows were set to be the same as the output images of the prime candidate camera model. Thus, the VR animations show as realistically as possible what the DONEs RH operators will see during the maintenance operations (as shown in figure 29). Furthermore, the VR model allows to assess the cameras locations and identify the optimal one (also in terms of number of cameras) [17].

The calibration between the VR and the reality will depend and has been performed on the basis of the type of sensors used. Position sensors are essential for tracking the movement of RH Devices, and can be relative (incremental) sensors, which measure displacement from a reference point, and absolute sensors, which always provide a fixed position. Incremental sensors, such as rotary encoders, require an initial calibration to establish a reference. If power is lost, the

system must recalibrate before resuming operations. Absolute sensors, like absolute encoders or vision-based tracking, continuously provide position data without recalibration, ensuring greater reliability.

If the radiation levels to which the sensors mounted on RH devices are exposed could compromise their functionality and no radiation-hardened versions are available, the use of external sensors will be necessary. In this context, the VS can play a key role by incorporating tracking and pose estimation functionalities, using visual markers on RH devices [22] and external measurement systems such as high-precision laser sensors.

8. Main RH validation results achieved so far and planned for the future

Several experimental activities have been carried out in the context of IFMIF-DONES, focusing on two primary tasks: the validation of the RH components to be used in the TC [23] and the design of the RH control system. The final objective of the validation activities is to develop and analyze an integrated RH maintenance procedure for the TC components, accounting also for failure and rescue in future experimental activities (2024–2027). Furthermore, the validation activities adopted the Divertor Refurbishment Platform (DRP) lab of ENEA C.R. Brasimone, a multipurpose RH facility housing a robotic system similar to the one of DONEs AC. The current activities (2022–2024) involve the validation of the ECs bridge of the HFTM [24], the TAA connection system, and the selection of technologies for the RH control system. The following experimental activities (2024–2027) will involve procuring the TC components not yet available (i.e. the HFTM mock-up) and integrating them in a full-size TC mock-up to test and validate the maintenance operations on the TC components. Furthermore, a second facility in University of Granada (UGR) have been realized to test and validate the technologies for the RH CS.

8.1. RH validation for the ECs bridge for the HFTM

The EC bridge for the HFTM is a critical subsystem that delivers all the I&C signals to monitor the irradiation conditions of the specimens. The EC bridge comprises two floating multi-connector plates, each with 16 alumina-insulated EC, housed in a solid metal structure. This system has been subject of a thorough validation campaign, and the results are presented in [24].

Figure 30 shows a view of the EC bridge mock-up RH maintenance [24]. The bridge suitability for RH has been assessed with a thorough RH maintenance analysis, also testing the insulation properties of the alumina EC prototypes [24]. The experimental analysis highlighted that the EC bridge is suitable for RH, albeit with some required design modifications to the alignment and emergency-related system. The analysis also tested the properties of the alumina insulation

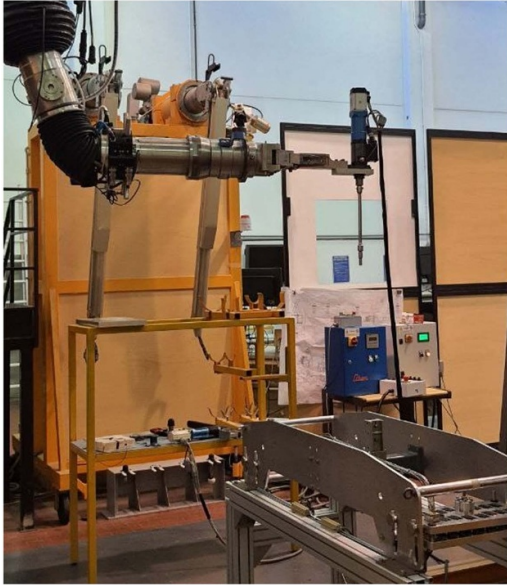

Figure 30. View of the RH maintenance tests on the DONES EC bridge. Reproduced from [24]. CC BY 4.0.

highlighting major shortcomings in the insulation resistance of the ECs. Therefore, a redesign of the ECs was completed with Glenair(It) and will be the subject of an irradiation test campaign in the MARIA nuclear reactor (PL).

8.2. RH validation for the new connection system for the target assembly

The connection system of the TAA has been modified, with respect to the previous DONES design, to include the fast disconnecting system (FDS) [18] directly on the beam line so that, in total, two connection systems will be installed on the DONES TAA. The FDS is composed of a rigid metallic chain that is tightened/released by acting on the FDS rods [18]. The connection system also uses a one point mechanism (OPM) to expand and compress the bellows by acting on the worm gearboxes thanks to the flexible shafts, which detaches the TAA. Then, once the bellow is fully extended, the FDS is closed by acting on the FDS rods ensuring the vacuum tightness of the connected flanges. Figure 31 shows a schematic view of the connection system as designed.

The analysis of the connection system focused on the repeatability of the foreseen RH operations, particularly on the extension/compression of the bellows and the correct engagement of the FDS by the moving flange. The OPM was thoroughly tested, being able to always complete the compression and extension of the bellows. The tests also testified the reliability of the mechanism, achieving final extended positions (after 130 revolutions) with a discrepancy below 0.1 mm. This low discrepancy is more attributed to manufacturing than to the quality of the OPM [25]. The OPM system was indeed able, both during hands on and using the Bolting tool, to equally transmit the torque to the flexible shafts. During the

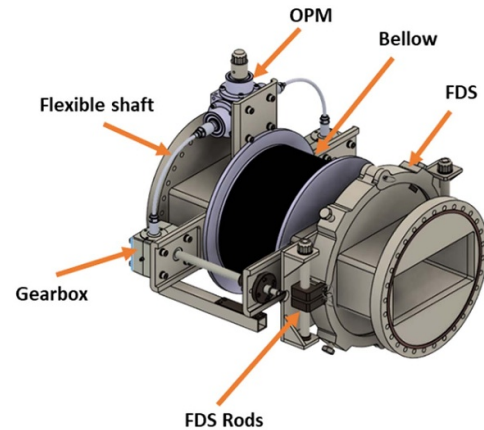

Figure 31. Schematic view of the compression system prototype. Reproduced from [25]. CC BY 4.0.

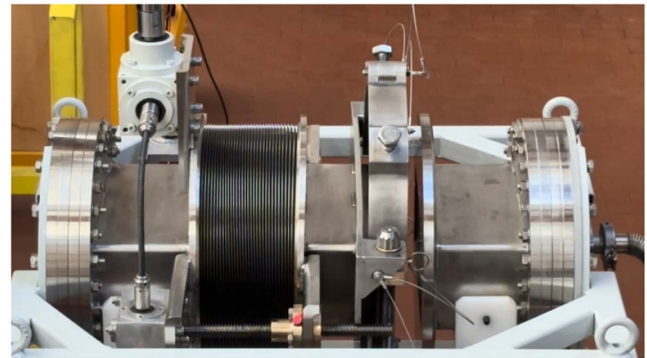

Figure 32. View of the FDS extension process. Reproduced from [25]. CC BY 4.0.

test it was measured that five rotations of the OPM corresponds to one rotation in the flexible shafts (observed on both sides) translating to a 5:1 reduction ratio. Furthermore, it was validated that the 5:1 ratio between the OPM and the flanges is kept for the entire extension/compression cycle. However, a non-perfect engagement of the flanges (~ 0.5 mm) is indeed observed after complete extension of the bellow, this misalignment never compromised the tightening of the FDS. Figure 32 shows a view of the extension process of the FDS before engaging the fixed flange (on the right).

Then, the entire connection assembly was tested to measure the leak rate using a Pfeiffer ASM-340 leak detector. The FDS was tested using three different gaskets, a rubber one (Viton O-ring), and two spring energized metal seals. The metal gaskets are made of two different metals with different compressibility, the first type is made of 304 stainless steel with a compressibility $Y = 200 \text{ N mm}^{-1}$. The second type is made of Inconel 718 with compressibility $Y = 100 \text{ N mm}^{-1}$. Using the second gasket the system was indeed able to achieve satisfactory leak rates (below $10^{-11} \text{ Pa m}^3 \text{ s}^{-1}$) when bolted at 80–100 Nm, while using the SS304 one the leak rate achieved was not satisfactory even when bolting the FDS to 270 Nm.

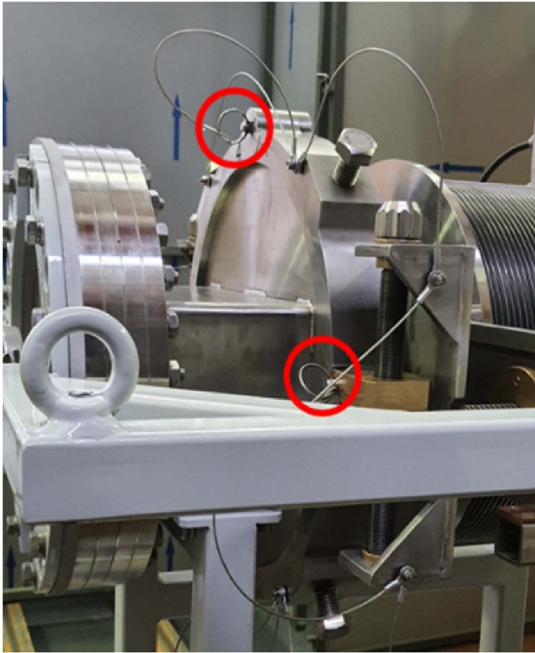

Figure 33. View of the FDS safety pins.

The experimental activity also analyzed all the emergency-related components and found out that improvements are indeed necessary to enable for the rescue operations, as currently, the detachment pins (highlighted in figure 33) are unable to move when the FDS is tightened at nominal torque [25]. The detachment pins are needed in the case where the FDS rods are damaged and unable to detach the chain. In such occasion, the pins would be removed suppressing the link between the segments and enabling the opening of the FDS.

The experimental validation highlighted that the system is indeed suitable to RH, the FDS-OPM connection system was indeed capable of engaging and disengaging the beam-line mock-up. Furthermore, using the Inconel 718 gasket satisfactory leak rates were achieved. However, the safety related components requires redesign and assessment of the system transmission in DONES like conditions is necessary.

8.3. Validation of technologies for the RH control system

In the engineering design phase of the IFMIF-DONES RHS, one of the main objectives has been to propose a RHCS capable of providing the necessary functionality to perform the tasks efficiently, safely, and easily enough for the operators to use. This is a significant challenge, as introduced in section 6, considering two critical aspects: the RH devices for IFMIF-DONES will be in-kind contributions with different communication standards (heterogeneity of technologies), and the general lack of information about control system needs at this stage. Therefore, for the design phase of the RHCS, the focus

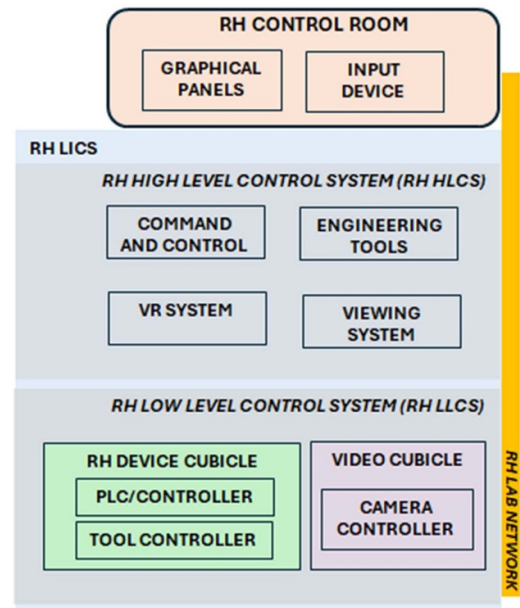

Figure 34. Simplified RHCS architecture of DONES RH Lab.

has been on, identifying the high-level requirements, prospecting for software tools, defining the architecture for the RH control system, and studying candidate technologies for data and interface standardization.

The DONES RH Lab has been created at the UGR to support and validate these proposals. A simplified version of the control system is proposed in figure 34, dedicated to the control of the devices listed in figure 35. The goal is to develop a stand-alone RHS capable of executing RH tasks by leveraging industrial tools and standards already included in the components used. Focusing on the functional aspect, only 4 of the HLCS modules are strictly required to execute a tele-manipulation task:

- Engineering tools: enable configuration and setup of the devices.
- Command and control: provide user interfaces for interacting with the devices.
- VR system: offers a real-time virtual scene of the workspace.
- VS: provides real-time video stream from the laboratory cameras.

The functionalities implemented in the test bench have been successfully validated by executing a simplified procedure of the extraction of irradiated material samples. Due to its high complexity and accuracy requirements, it serves as a benchmark to validate the system's ability to perform other RH operations, including those expected during maintenance campaigns.

The procedure follows strict RH principles, avoiding direct manual intervention in the work area. The operator, positioned without a direct view of the robotic cell, relies solely on the camera system and virtual scene for guidance as shown

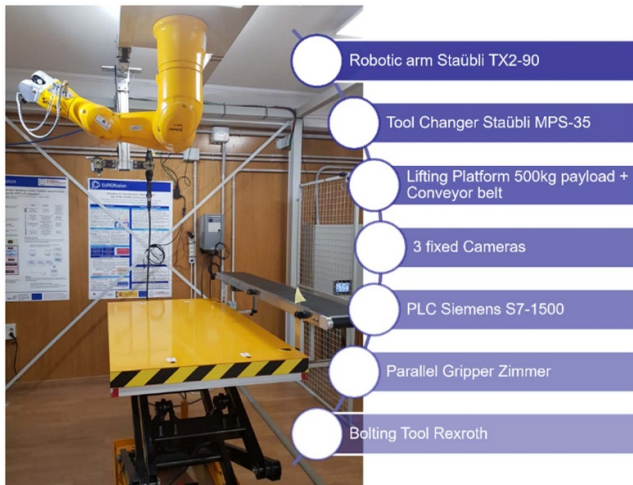

Figure 35. Devices of DONES RH Lab at UGR. Image Courtesy of Francisco Barranco (UGR-ES) and Elio Valenzuela (PHD student at UGR-ES).

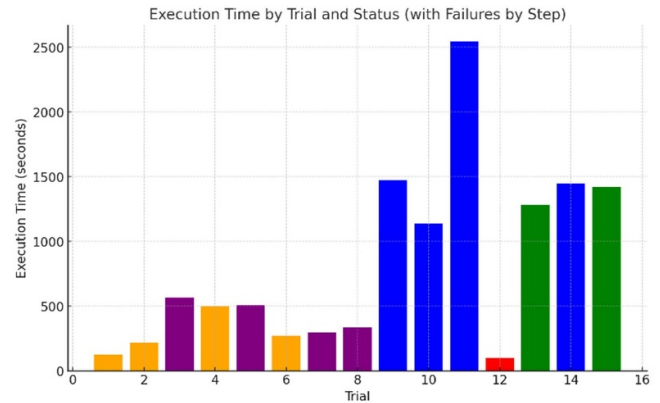

Figure 37. Execution time per trial. ‘The green color indicates that sequence is completed following the described RH procedure without any deviation, other colors show in which step the error occurred: red: step 1, orange: step 2, purple: step 3, blue: step 4, green: PASS’. Image Courtesy of Francisco Barranco (UGR-ES) and Elio Valenzuela (PHD student at UGR-ES).



Figure 36. Operator Workstation without direct view to the robotic cell. Image Courtesy of Francisco Barranco (UGR-ES) and Elio Valenzuela (PHD student at UGR-ES).

in figure 36. The operation is structured into four high-level steps:

1. Capsule introduction: positioning the capsule within the manipulator’s reach.
2. Placement on the work surface: picking up the capsule and placing it on the lifting platform.
3. Simulated cutting: using a pointer tool to mark the capsule’s edges.
4. Sample extraction and placement: removing and positioning samples in designated areas.

Results of the first fifteen trials are shown in figure 37. The task was successfully performed in a semi-structured environment after twelve trials, demonstrating the importance of training and highlighting the possible benefits of simulation-based procedure refinement to minimize errors before execution. Additionally, motion planning integration and offloading

kinematic calculations to an RH HLCS module were identified as critical improvements to enhance efficiency and reduce execution times.

The results show how the operator progressively learns and completes the described sequence through trial and error. The high-level definition of the tasks leaves several aspects to the operator’s discretion, such as the choice of trajectories, the movement speeds for each device, or the specific order of sample extraction. The difference between attempt 13 and 15 can be seen in the final positioning of the samples shown in figure 38.

The initial results obtained from this laboratory confirm the suitability of the preliminary technologies selected for the RHCS design, as well as the viability of a custom interface between OPC UA and EPICS for the integration of the RHCS with the CICS [21]. The adoption of industrial tools and standards has also proven advantageous, significantly reducing development time while leveraging the built-in functionalities provided by device manufacturers.

Future work will focus on extending system functionalities: integrating the haptic force feedback control for the RA, prototyping the supervision system, integrating AI techniques based on neural networks for object pose estimation to support telemanipulation, and unifying kinematics and motion planning for process automation using Robot Operating System (ROS2). Ongoing activities involve the deployment of Time-Sensitive Networking (TSN) in the robotic cell to support different traffic profiles, ensuring network determinism and low latency while consolidating multiple communication layers into a unified network infrastructure.

8.4. Future experimental program

In the framework of IFMIF-DONES RH maintenance for the TS, developing and validating the RH procedures for servicing the TC is of primary importance. Therefore, the future experimental program (2024–2027) will foresee the procurement

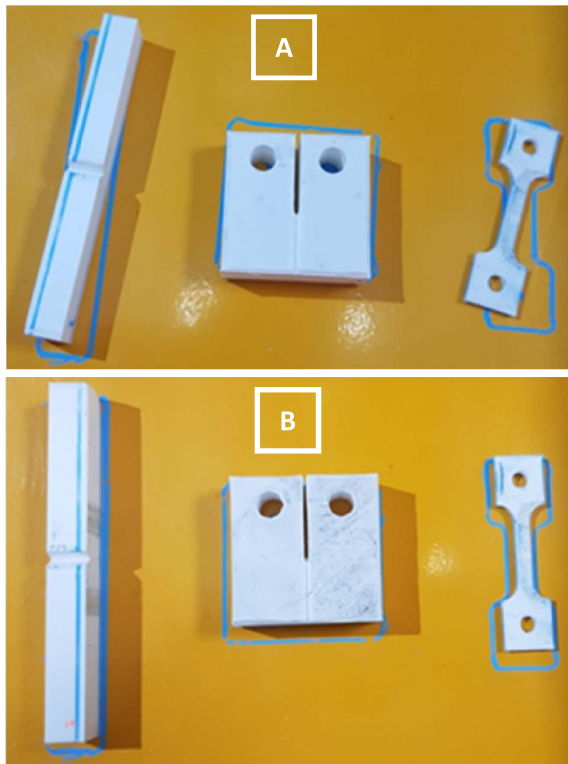

Figure 38. Final position of the extracted samples in designated areas. (A) shows trial 13, (B) shows trial 15.

and integration of the TC components in the DRP lab. In particular, the previously available TAA for IFMIF will be adapted to the IFMIF-DONES design by including the current version of the connection system. Then, a mock-up of the HFTM will be procured along with the locking system and a suitable connection system to mimic the PCP to house the EC bridge. Figure 39 shows the RH maintenance process for the maintenance of components in the TC. This RH maintenance procedure is general and provides a high-level view of the operations required for servicing IFMIF-DONES TC. In the context of the integrated test campaign on the TC components, this procedure will be expanded with the actual RH maintenance procedure for each subtask (i.e. the HFTM removal) accounting for the DRP lab RHS. The experimental activities will test and validate the RH procedure, analyzing potential failures and emergency-related systems to complete the rescue scenarios.

9. Conclusions

The maintenance of DONES systems and components is a very challenging activity requiring the use of RH technologies. There are no other facilities with similar requirements in terms of radiation levels and complexity like DONES. Over the last 5 years a great enhancement of the RHS design and of the maintenance process definition has been achieved. Several RHE are ready for the procurement, such as the HROC and the ACMC, other RHE are very well defined but there are still design work to be done being their level of maturity at the level of preliminary design phase or even more. A big effort

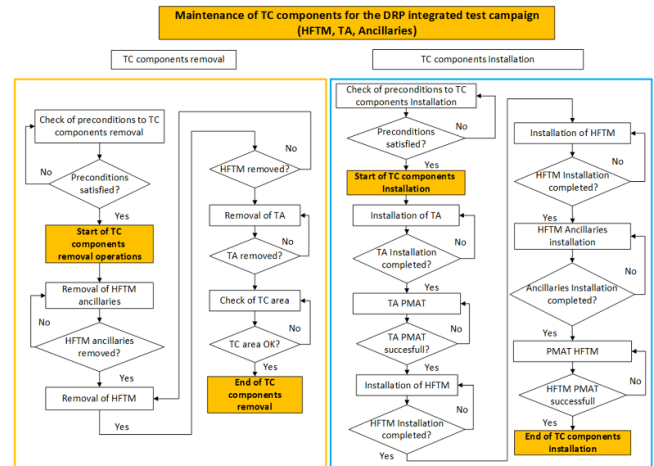

Figure 39. DONES TC RH maintenance procedure.

is going on with the virtual simulation of the maintenance process extensively used for the validation of the maintenance procedures and for the assessment of the suitability of the RHE developed. Almost all the pictures of this paper are taken from the virtual simulation movies.

A wide range of validation activities by using full scale mock-ups of components are still executing by national laboratories and future experimental test campaigns are planned. The most important one is the testing of the entire maintenance process of the TC components that will be performed from 2025 to 2027 and beyond. This latter test campaign is of a paramount importance for the final updating of the engineering design of the critical components requiring maintenance via RH.

Acknowledgments

This work has been carried out within the framework of the EUROfusion Consortium, funded by the European Union via the Euratom Research and Training Programme (Grant Agreement No 101052200—EUROfusion). Views and opinions expressed are however those of the author(s) only and do not necessarily reflect those of the European Union or the European Commission. Neither the European Union nor the European Commission can be held responsible for them.

ORCID iDs

F. Arranz [ID https://orcid.org/0000-0002-9591-4096](https://orcid.org/0000-0002-9591-4096)
 M. Ferre [ID https://orcid.org/0000-0003-0030-1551](https://orcid.org/0000-0003-0030-1551)
 F. Barranco [ID https://orcid.org/0000-0002-3721-0170](https://orcid.org/0000-0002-3721-0170)
 A. Zsákai [ID https://orcid.org/0000-0002-0645-3487](https://orcid.org/0000-0002-0645-3487)

References

- [1] Ibarra A. *et al* 2018 The IFMIF-DONES project: preliminary engineering design *IAEA Nucl. Fusion* **58** 105002

- [2] Micciché G. 2024 Basic guidelines for the design of remotely maintained components in DONES, *Eurofusion IDM*, EFDA_D_2NG7SN V1.0 (Accessed 16 July 2024)
- [3] Micciché G. *et al* 2019 The remote handling system of IFMIF-DONES *Fusion Eng. Des.* **146** 2786–90
- [4] Qiu Y. *et al* 2024 Overview of recent advancements in IFMIF-DONES neutronics activities *Fusion Eng. Des.* **201** 114242
- [5] David O., Micciché G., Ibarra A., Friconneau J.-P. and Piazza G. 2009 Overview of the preliminary remote handling handbook for IFMIF *Fusion Eng. Des.* **84** 660–4
- [6] Zsákai A. *et al* 2024 Evolution of IFMIF-DONES' heart: system overview of the Test Cell *J. Nucl. Mater.* **598** 155185
- [7] Macià L. *et al* 2024 Engineering design status of IFMIF-DONES high energy beam transport line and beam dump system inside the TIR and RIZ *Fusion Eng. Des.* **202** 114312
- [8] Tripodo C., Lorenzi S., Cammi A. and Micciché G. 2022 Object-oriented modeling, simulation and control of a 6-DoF parallel kinematic manipulator for remote handling in DONES facility *Fusion Eng. Des.* **184** 113304
- [9] Redondo Gallego V. *et al* 2023 Design and evaluation of a passive gripper for remote manipulation tasks *ROBOT2022: Fifth Iberian Robotics Conf. (Lecture Notes in Networks and Systems (Zaragoza, November 2022))* vol 589 (Springer) pp 53–64
- [10] Nomen O. *et al* 2020 Preliminary design of the HEBT of IFMIF DONES *Fusion Eng. Des.* **153** 111515
- [11] Podadera I. *et al* 2021 The accelerator system of IFMIF-DONES multi-MW facility *12th Int. Particle Accelerator Conf. (IPAC21) (Virtual Edition, Brazil, 24–28 May 2021)* (<https://doi.org/10.18429/JACOW-IPAC2021-TUPAB211>)
- [12] Sanchez-Herranz D., Nomen O., Arranz F., Coloma S., Podadera I. and Varela R. 2021 Design of HEBT components inside the TIR room of IFMIF-DONES facility *Fusion Eng. Des.* **168** 112636
- [13] Sánchez-Herranz D., Ortego P., Nomen O., Brañas B., Ogando F., Sauvan P., Arranz F. and Coloma S. 2020 Design and configurations for the shielding of the beam dump of IFMIF DONES *Fusion Eng. Des.* **153** 111475
- [14] Coloma S., Ferre M., Arranz F., Micciché G., Sánchez-Herranz D., Nomen O. and Cogollor J.M. 2021 Remote handling maintenance of beam dump in IFMIF-DONES *Fusion Eng. Des.* **165** 112216
- [15] Arranz F., Micciché G., Coloma S., Sanchez-Herranz D., Nomen O., Ferre M. and Ibarra A. 2020 Remote handling in the accelerator systems of DONES *IEEE Trans. Plasma Sci.* **48** 1743–7
- [16] Arranz F. *et al* 2024 Alignment strategy for IFMIF-DONES facility *Fusion Eng. Des.* **200** 114181
- [17] Rouret M., Varga K.L., Fuentes A.B., Arranz F., Ros E. and Garrido J.A. 2021 An efficient workflow for virtual reality simulation of maintenance tasks in IFMIF-DONES *Prog. Nucl. Energy* **160** 104681
- [18] Micciché G. *et al* 2013 A fast disconnecting system for the European concept of IFMIF target assembly *Proc. SOFE (Symp. on Fusion Engineering) (San Francisco (USA), 10–14 June 2013)* pp 1–5
- [19] Arena P., Bernardi D., Di Maio P.A., Frisoni M., Gordeev S., Micciché G., Nitti F.S. and Ibarra A. 2019 The design of the DONES lithium target system *Fusion Eng. Des.* **146** 1135–9
- [20] Zsákai A. *et al* 2023 Integrated design of the vacuum and safety barrier between the lithium and test systems of IFMIF-DONES *J. Nucl. Eng.* **4** 49–58
- [21] Valenzuela E., Cano-Delgado A., Cruz-Miranda J., Rouret M., Micciché G., Ros E., Arranz F. and Diaz J. 2023 The IFMIF-DONES remote handling control system: experimental setup for OPC UA integration *Fusion Eng. Des.* **192** 113776
- [22] Ribeiro L.G. *et al* 2022 ITER-Tag: an adaptable framework for robust uncoded fiducial marker detection and identification, *2022 10th European Workshop on Visual Information Processing (EUVIP) (Lisbon, Portugal, 11–14 September 2022)* pp 1–6
- [23] Bernardi D., Arena P., Benzoni G., Di Ronco A., Favuzza P., Micciché G., Nitti F.S. and Cammi A. 2024 Validation activities at ENEA Brasimone in support of the IFMIF-DONES design *J. Nucl. Mater.* **599** 155206
- [24] Benzoni G., Di Ronco A., Introini C., Micciché G. and Cammi A. 2024 Remote handling experimental analysis of the IFMIF-DONES high flux test module electrical connectors bridge *IEEE Trans. Plasma Sci.* **52** 3668–73
- [25] Benzoni G. *et al* 2024 Remote handling validation of the OPM-FDS connecting system for the IFMIF-DONES target assembly *Symp. on Fusion Technologies SOFT 33 (Dublin (Ireland), 22–27 September 2024)*