





## Article

# Status, Features, and Future Development of the LIFUS5/Mod4 Experimental Facility Design

Nicolò Badodi <sup>1</sup>, Marica Eboli <sup>2</sup>, Antonio Cammi <sup>1</sup> and Alessandro Del Nevo <sup>2,\*</sup><sup>1</sup> DENG, Politecnico di Milano, 20156 Milano, Italy<sup>2</sup> ENEA FSN-ING C.R. Brasimone, 40032 Camugnano, Italy

\* Correspondence: alessandro.delnevo@enea.it; Tel.: +39-0534801130

**Abstract:** The Water-Cooled Lithium–Lead (WCLL) is one of the most promising technologies for power conversion and tritium production in future fusion-powered reactors; it will be implemented in one of the Test Breeding Modules (TBM) inside the ITER reactor and the DEMO EU reactor. However, the simultaneous presence in the system of high-temperature PbLi and high-pressure water poses significant safety issues in the event of an in-box LOCA (Loss Of Coolant Accident). For this reason, a complete understanding of the system response is crucial to avoid extensive damage in such a scenario. This paper describes the status and design features of the LIFUS5/Mod4 facility, an experimental plant that is currently being designed and constructed at ENEA CR Brasimone in the framework of the FP9 EUROfusion Horizon Europe to address these issues. This facility aims at being representative of the geometry and operational conditions of the Test Breeding System (TBS) to allow the precise reproduction of its behavior under simulated incidental scenarios. For this reason, peculiar design choices have been made, which will be extensively discussed throughout this work and which will allow the generation of high-quality data useful for the TBS development. Moreover, the facility is expected to become a test stand for the implementation of different safety functions, to identify the best accident-mitigation strategy. Possible upgrade plans for the facility are described as well, with the chance for it to become a fully functional test stand for any component of the TBS in their operative conditions.

**Keywords:** integral test facility experiment; PbLi/water reaction; in-box LOCA; WCLL breeding blanket; LIFUS5/Mod4



**Citation:** Badodi, N.; Eboli, M.; Cammi, A.; Del Nevo, A. Status, Features, and Future Development of the LIFUS5/Mod4 Experimental Facility Design. *Appl. Sci.* **2023**, *13*, 482. <https://doi.org/10.3390/app13010482>

Academic Editor: Gang Lei

Received: 29 November 2022

Revised: 21 December 2022

Accepted: 26 December 2022

Published: 29 December 2022



**Copyright:** © 2022 by the authors. Licensee MDPI, Basel, Switzerland. This article is an open access article distributed under the terms and conditions of the Creative Commons Attribution (CC BY) license (<https://creativecommons.org/licenses/by/4.0/>).

## 1. Introduction

### *Scope of the Work*

In the framework of the development of fusion technology, the Water-Cooled Lithium–Lead (WCLL) is one of the most prominent candidates to address the issue of tritium breeding and power conversion. This technology will be implemented and tested in one of the two Test Breeding Modules (TBMs) that will be installed in the ITER reactor and the DEMO EU reactor [1–3].

The concept of the WCLL TBM/BB is based on the simultaneous presence in the reactor wall of flowing Pb–Li eutectic alloy, which is used for neutron multiplication and tritium breeding, and water, which serves as a coolant for the system. This coexistence of water and molten alloy poses several questions for the safety of the technology, especially in the case of the worst possible postulated accidental scenario, an in-box LOCA, in which one of the TBM water-cooling pipes is expected to rupture [4–6].

To address these issues, several experiments have been and are being performed, to deepen the understanding of the underlying phenomena that occur in this scenario, both from the physical and chemical points of view [7–9]. Previous experiments performed at ENEA Brasimone Research Centre on the LIFUS5/Mod3 facility focused on the separate-effect study of the PbLi–water interaction, isolating it from the structure response, to

highlight the thermochemical interactions between the two substances. These experiments allowed the collection of a set of data that lead to a deep understanding of the phenomena and the implementation and validation of chemical reaction models inside dedicated numerical codes [10–12].

However, these experiments did not investigate the response of the structures to the strong pressure variations and temperature changes induced by the two fluids' interaction. For this reason, a new integral-effect facility is being constructed at the Brasimone RC, based on the previous expertise acquired on the existing experimental plants.

The new facility, namely the LIFUS5/Mod4, aims at studying the actual response of the WCLL-TBS both during nominal operation and in-box LOCA incidental scenarios.

It will be composed of a 1:1 reproduction of the ITER WCLL-TBS PbLi loop and it will try to mimic and reproduce its hydraulic behavior as closely as possible, aligning itself to the main objectives of the FP9 Horizon Europe EUROfusion WPBB [13]. The main expected scientific outcomes and technological advancements of this facility will include:

- Generating data applicable to the full-scale ITER WCLL Test Blanket System (TBS) conditions that may be directly used for the safety analysis;
- Providing integral test facility data for the understanding and the study of the “in-box Loss Of Coolant Accident” transient progression in the WCLL BB of DEMO;
- Supporting the development and demonstrating the reliability (i.e., validation and qualification) of computer codes, coupling techniques, and procedures for code use, when applied for simulating the behavior of the “in-box Loss Of Coolant Accident” at a system level.

To simulate the exact conditions that the components will encounter during the actual reactor operation, the LIFUS4/Mod4 will be connected to a second and much larger facility, named Water Loop (WL). This second facility will be composed of a loop that will mimic the ITER WCLL Water Cooling System (WCS). Inside it, water will be circulated at PWR-like conditions, i.e., 155 bar and 295–328 °C. These conditions will be reached through a 1 MW electrical heater that simulates the power transfer from the reactor breeding blanket to the primary water loop [14].

By coupling the WL and LIFUS5/Mod4, the facilities will be able to simulate system operation and in-box LOCA events maintaining the representativeness of the thermodynamical phenomena, hydraulic conditions, and dynamical behavior of the loops. Moreover, after the incidental scenarios experimental campaigns, these facilities could become comprehensive test stands for the nominal operation and calibration of the related systems, thanks to their precise representativeness of the associated loops. These further experimental activities could also include the development of new and improved diagnostic systems, such as a small leak detection system to predict and prevent the onset of a full in-box LOCA during reactor operation, extending the previous experience on small leak detection for fission applications [15].

In this work a comprehensive summary of the status of the LIFUS5/Mod4 facility conceptual design is presented, together with the main objectives of the project and the foreseen next steps toward its completion.

## 2. Objectives and Requirements

The main goal of the LIFUS5/Mod4 facility, as anticipated in the previous paragraph, is to study the nominal and incidental behavior of the ITER WCLL TBS. To do this, the plant operation has been subdivided into two different phases: a short-term and a long-term operation phase, as indicated in Figure 1.

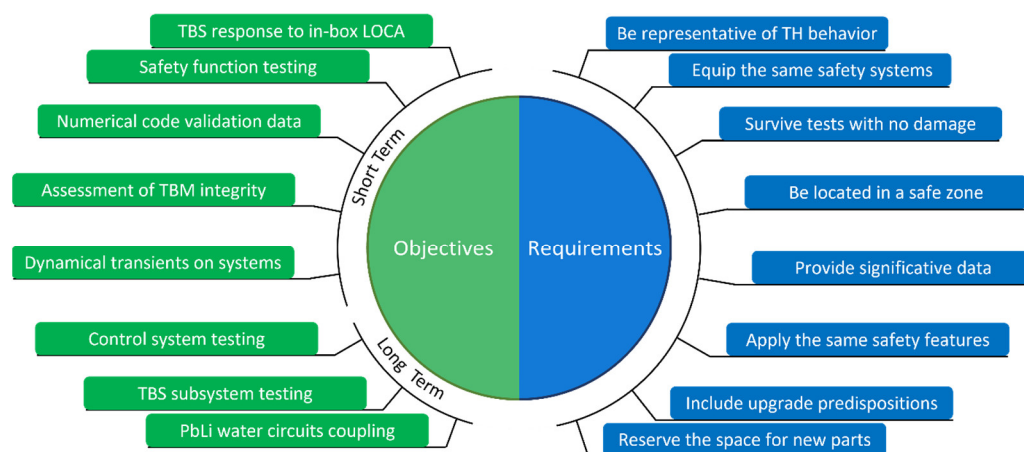

**Figure 1.** Objectives and requirements of LIFUS5/Mod4 facility.

The former one will see the facility being configured as a stagnant loop in which simulated in-box LOCA events will be performed on small-scale TBM mock-ups, with the following objectives:

- Expansion of the existing database for code validation [16] by acquiring relevant data on all the involved thermodynamical parameters;
- Assessment and validation of the TBM design and ability to withstand in-box LOCA events without any major operational disruption [17];
- Testing the dynamical response of the system to loads typical of incidental scenarios;
- Testing different incidental safety functions and their performance in mitigating possible outcomes of the incidental scenarios.

During the long-term operational phase, the facility will be converted to serve as a comprehensive test stand for components and system testing in nominal operating conditions. The main objectives of this phase are:

- Testing the control system and determining the best control strategies for the optimal performance of the TBS;
- Testing subsystems and components in different configurations and with different designs;
- Studying the dynamical behavior of water and PbLi circuit coupling.

To meet all its goals, the facility has been designed with a precise set of requirements in mind, it must:

- Be as representative as possible of the hydraulic behavior of the real ITER WCLL TBS circuit;
- Survive with no or minimal damage from the violent energy release caused by the tests;
- Include a set of sensors able to provide significant data on all the relevant parameters involved in the interaction;
- Implement control and safety features equivalent to the ones that are present in the real plants;
- Include the predisposition for upgrades that will be implemented between the short- and long-term operations.

Satisfying all the requirements calls for challenging planning work. Most of the effort was concentrated on ensuring that the piping layout (and thus the associated pressure losses) are equivalent between the facility and the ITER TBS. This ensures that the thermohydraulic and thermodynamical behavior of the system will mimic exactly the one expected during reactor operation.

Moreover, to ensure that all the effects from all the sources are kept into consideration, a feasibility study to include the effects of Magnetohydrodynamic (MHD) forces has been

carried out by the private company LTCALCOLI. The result of the study was that it would be possible to include a passively cooled magnet in the facility that would subject the mock-up to a maximum magnetic field of 0.3T during the entire duration of the test [18]. This would allow, thanks to the usage of suitable scaling laws, to provide data for the validation of numerical codes used to predict the MHD effect on the WCLL component response. However, the actual decision on either including or not the magnet into the facility has been postponed to a future stage of the design process, to ensure a thorough evaluation of the scientific benefits that such action would provide [19].

The final operational characteristics foreseen for the LIFUS5/Mod4 facility are re-capped in Table 1.

**Table 1.** LIFUS4/Mod4 Operational characteristics.

General Characteristics		
	Short-Term Operation	Long-Term Operation
Facility type	Stagnant PbLi loop	Forced circulation PbLi loop
Operating fluid	Eutectic PbLi alloy (Li 17%, Pb 83%)	Eutectic PbLi alloy (Li 17%, Pb 83%)
Heat source and power	Heating wires and bands	Heating wires and bands
Hydraulic characteristics		
	Short-term operation	Long-term operation
Fluid	Pb-83 Li-17 eutectic alloy	Pb-83 Li-17 eutectic alloy
PbLi Inventory	0.593 m <sup>3</sup>	0.593 m <sup>3</sup>
Operating temperature range	350–450 °C	350–450 °C
Operating pressure	0.1 MPa	0.75 MPa
Design pressure	18.5 MPa	18.5 MPa
Operating mass flow rate	0 kg/s	0.65 (up to 1.18) kg/s
Key instrumentation	Fast pressure transducers, strain gauges, hydrogen analysis system, thermocouples, and level meters.	Fast pressure transducers, strain gauges, hydrogen analysis system, thermocouples, and level meters.

### 3. Materials and Methods

#### 3.1. General Facility Layout

The general layout of the facility is shown in the process flow diagram in Figure 2. The main components that will compose the facility are the recirculation tank SE-LSS-001, the Tritium Extraction Unit (TEU) equivalent volume SE-LTS-001, the relief tank SE-LRS-001, and the test section. These have been designed to be as representative as possible of the equivalent components foreseen to be installed in the ITER TBS [13,20]. The piping itself was designed with the main goal of maintaining the same dynamical pressure losses, heights, and amount of bends of the real system [13,21,22]. This will ensure that, during the tests, the phenomena will be correctly represented and captured, so that significant data can be produced. Some differences with the real system have been introduced during the conceptual design. In particular:

- The auxiliary bypass lines used for maintenance have been removed to simplify the facility design, construction, and operation.
- The cold trap has been removed. The phase 1 experimental campaign aims at testing the TBM in incidental conditions, for this reason the cold trap has been labeled as non-fundamental for the execution of this first task.
- The recirculation pump has been removed to avoid damage during the in-box LOCA test execution.
- Only a couple of isolation valves (VP-LLL-I01 and VP-LLL-I02), equivalent to the SIC-1 valves, have been maintained, whereas the SIC-2 valves have been removed.

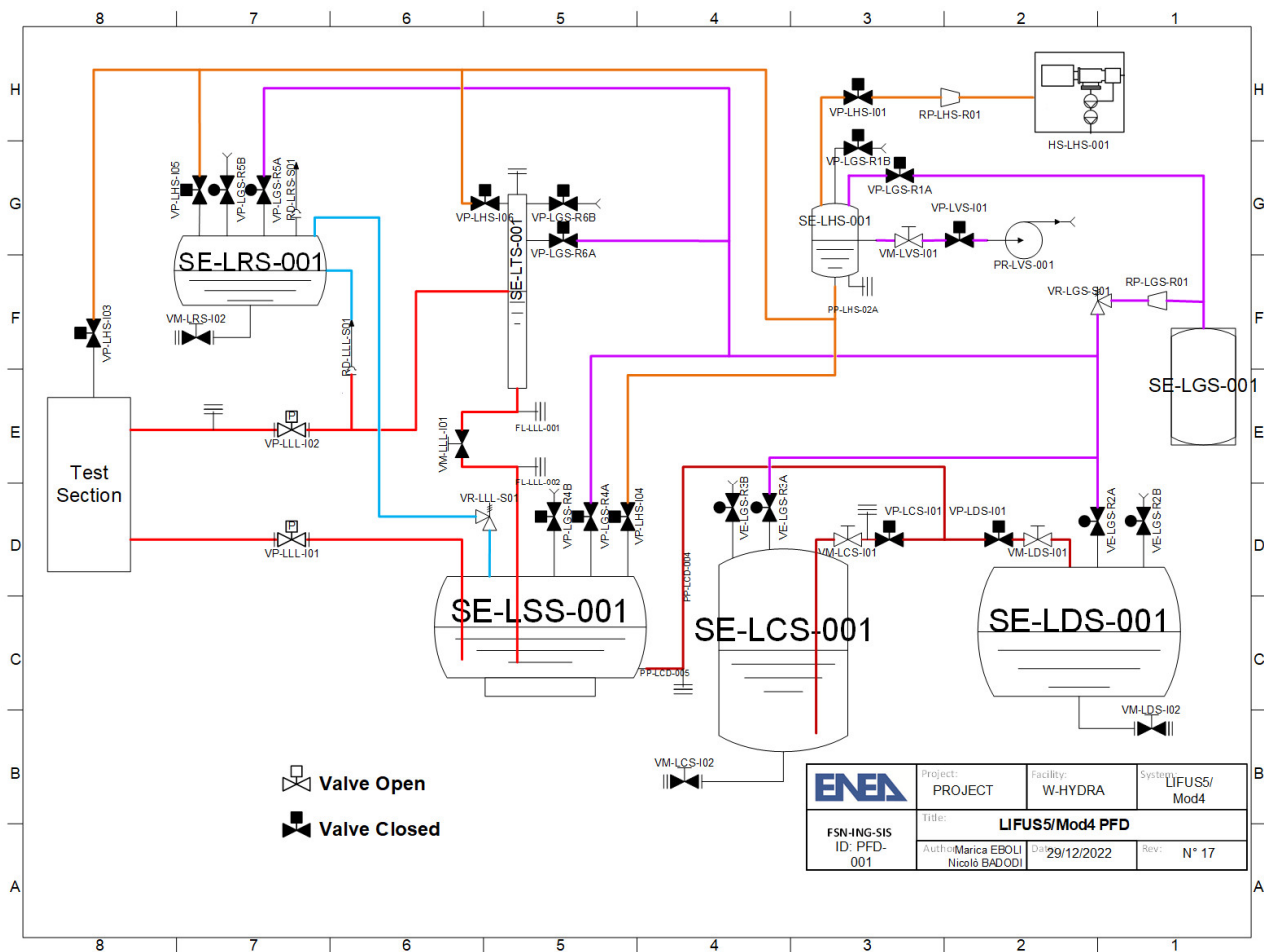

Figure 2. LIFUS5/Mod4 PFD.

All these differences between the facility and the real system have been deemed as non-interfering with the experimental campaign results. Moreover, several upgrade points have been predisposed to install components used during the second phase of the experimentation.

Another difference with the real system is that PbLi will not entirely be contained in the recirculation tank. Instead, the facility will be equipped with storage and draining tanks. Only the minimum amount of PbLi needed for executing each test will be loaded at a time from the storage tank and after each test, it will be discharged in the draining tank. The advantage of proceeding in this way is twofold:

- The contamination of large amounts of PbLi by reaction products (mainly oxides) is avoided and only the smallest amount of alloy is therefore consumed during each test;
- After each test, the facility can be completely drained and cleaned to remove any obstruction caused by the presence in the system of lumps of oxides and hydroxides produced by the interaction with water. This is fundamental because these reaction products have a higher melting point than the alloy itself and tend to plug the piping.

The main component in which the most effort converged to ensure representativeness was the piping. It was designed starting from CAD drawings of the real system and simplified to reduce complexity without loss of representativeness. Figure 3 shows the results of the analysis to determine the representativeness degree of the final layout of the facility. It can be noticed how the piping length was maintained almost equal to the original one, except for small discrepancies. An effort was made to also maintain the same number of 90° bends in the piping, this will help in matching the final pressure losses by choosing the most appropriate standard bend radius. The pipe external diameter was maintained

throughout the whole facility, however, the schedule utilized for the experimental facility is different than in the real plant. The design pressure of the former was set to 185 bar and required SCH80 piping in the high-pressure zone, whereas the latter was designed using SCH40 piping. This difference will be taken into account during data postprocessing where scaling laws can then be applied to compensate for the difference in the passage area.

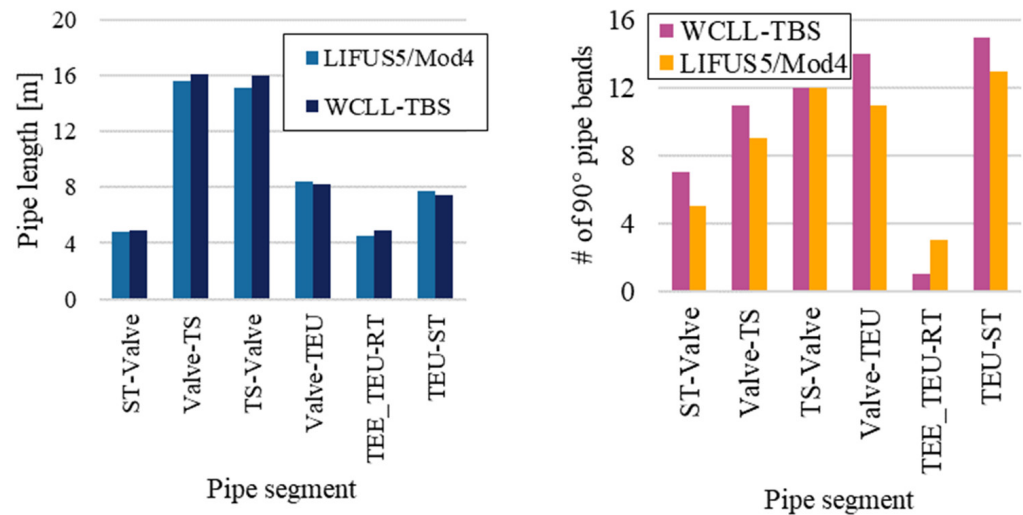

**Figure 3.** L5M4-TBS piping comparison. **Left:** comparison between main lines length. **Right:** comparison of the number of 90° bends between the two piping systems.

### 3.2. Main Components

The main components of the facility have the duty of correctly reproducing the dynamical behavior of the system during the simulated transient. They are:

- The recirculation tank SE-LSS-001. This tank will be built with the same dimensions as the recirculation tank foreseen in the TBS. Since the mock-ups utilized during the in-box LOCA experimental campaign will be smaller than the actual TBM box, the tank will be oversized. However, it was decided to keep the same internal volume to reproduce the damping of pressure waves that could be generated during the PbLi–water interaction phase and that are foreseen to travel upstream through the piping.
- The TEU equivalent volume mock-up SE-LTS-001. This component simulates the presence of the TEU in the circuit. Its internal volume was kept equal to the one present in the original systems. This was due to the presence of gas inside the volume that is expected to damp pressure waves while they travel through the component.
- The pipe forest. Pipes that run from the isolation valves to the test section will maintain the same length and layout to reproduce the pressure wave propagation following an in-box LOCA event.
- The Relief Tank SE-LRS-001 is used to suppress excessive pressure inside the piping system. This component will be connected through a rupture disk designed to burst at the same pressure as the TBS-mounted one.
- The isolation valves VP-LLL-01/02. These valves will be equivalent both in size and performance to the SIC-1 valves foreseen to protect the TBS circuit during incidental scenarios. Not only will the valves be equivalent but also the sensor and control system that detect anomalies in the nominal performance of the loop will be installed and designed to reproduce the final foreseen configuration. This will allow the testing of the detection and protection system used to mitigate the incidental outcomes and also to test different response strategies applied to the system by the control logic.

The whole facility will be thermally insulated to maintain the temperature inside the components and the piping and ensure that the molten alloy does not freeze during each

test execution. The temperature will be controlled through heating cables that allow the control system to reach the desired state in each of the sections and components.

Moreover, the whole plant is connected to a pressurization system that allows the complete filling and draining of the loop with Argon gas. The main goals of this system are:

1. Migrating PbLi from one point of the facility to another via pressure difference. This method will be used for filling, draining, and controlling the facility during the first phase of the experimentation, when no recirculation pump will be installed.
2. Avoiding PbLi contact with air. This protects the alloy from oxidation due to the contact with both oxygen and the moisture present in the air.

During facility operation, the PbLi alloy will be stored in two main tanks, the SE-LCS-001 and the SE-LDS-001. The first one is the loading tank, its duty is to hold the fresh, unused PbLi alloy under an inert atmosphere, ready to be loaded into the recirculation tank before each test is performed. The latter one is the drain tank, which is used to store the alloy contaminated with oxides and other chemical reaction products after each test. This method of having two separate tanks allows performing in-box LOCA experiments in the same conditions that would happen inside the reactors, avoiding plugging and other issues due to the presence of metal oxides that melt at a higher temperature.

Moving the alloy to and from these tanks is performed via a pressure differential. The pressure inside the recirculation and loading/draining tanks is controlled via the argon distribution system, and isolation valves (VP-LCS-01 and VP-LDS-01) allow the PbLi to flow between them. Moreover, for safety reasons, manual valves are installed on the loading and draining lines to further isolate the tanks from the PbLi loop during the tests.

Each tank is then equipped with manual draining valves. They are used to empty the alloy from the tanks when the facility is refurbished. The level inside the loading tank is monitored via a continuous level meter that allows the precise measurement of the quantity of alloy moved to and from the tank to other parts of the facility. The draining tank is equipped with only on/off level meters that avoid overfilling.

### 3.3. Connection to W-HYDRA

During an in-box LOCA, the PbLi–water interaction occurring inside the TBM box is strongly influenced by the dynamical behavior of the respective connected loops. The inertia, inventory, and thermodynamical parameter in the water loop regulate the final amount of water injected into the system; the inertia of the PbLi loop counteracts the water injection and mitigates the LOCA effects. For this reason, it is extremely important that not only the PbLi circuit mimics exactly the behavior of the real system but also that the coupled water circuit can do the same.

To achieve this goal, the LIFUS5/Mod4 facility utilizes as a water source the Water Loop (WL) facility, which is being simultaneously built at Brasimone Research Centre and which mimics in a 1:1 configuration the ITER Water Cooling System (WCS). This allows performing the tests with the injected water with the same thermodynamical parameters and dynamical effects that are expected to occur during a real in-box LOCA event [14].

The connection between the two facilities is obtained using pipelines that have the same length as the WCS pipe forest, including the presence of delay tanks. These pipelines will be connected to the WCLL TBM mock-ups through an injection device, which will allow controlling the test execution and water injection. The exact layout and working principle of the injection device are still to be determined and it will be described in detail in future works, however, the following high-level requirements have been defined:

- It must allow for precise control of the timing of the water injection to allow the synchronization of the acquisition system with the event time;
- It must cause a net and fast surge of water into the test section, to simulate a complete pipe breakage and to allow for the water flashing;
- It must maintain a similar geometrical shape and the same hydraulic characteristics as the real water circuit.

The design of the injection system will be carried out to obtain the highest quality in the data generated by the facility and to maintain as much as possible the incidental scenario representativeness.

### 3.4. Instrumentation

#### 3.4.1. Instrumentation List and Description

To produce significant and impactful data on the phenomena occurring during the in-box LOCA, the facility will be equipped with sensors to monitor all the relevant thermodynamical parameters and actuators to control them. The choice of the position and the requirements of the sensors are based on an extensive numerical simulation campaign in which code chain methodologies were implemented to correctly reproduce the underlying phenomena expected [17,23]. Sensors and actuators will be composed of:

1. **Actuators:**
  - a. Heating wires for temperature control;
  - b. Regulation valves for flow control;
  - c. Safety valves and rupture disk for overpressure protection;
  - d. Inert gas distribution system for pressure regulation and oxidation protection;
  - e. Recirculation pump (foreseen to be installed after the first experimental phase and after the facility upgrade).
2. **Sensors:**
  - a. Thermocouples for temperature control;
  - b. Fast pressure transducers (10 kHz) for data acquisition of the pressure wave and fast pressure transients;
  - c. Absolute pressure transducers for pressure control;
  - d. Level meters for level monitoring inside the tanks;
  - e. Differential pressure meters for pressure loss monitoring and mass flow measurement;
  - f. Strain gauges for deformation measurement.

The sensors are then subdivided into three different categories according to their function:

- Control sensors. Used for control of the facility, they interact with the control system to allow the regulation of all the relevant parameters;
- Safety sensors. These are used for safety purposes, such as controlling that the heating cables would not exceed the maximum allowed temperature;
- Data acquisition sensors. They are used to acquire data on the phenomena occurring inside the facility.

A recap of the sensors foreseen to be installed in the facility is shown in Table 2. Notice how one sensor can be assigned to more than one group at a time if, for example, it can serve both safety and acquisition purposes.

**Table 2.** Recap of sensors mounted on the facility.

	Thermocouples	Level Meter	DP Meter	Pressure Gages
Total	206	9	6	15
Safety	58	6	0	15
Control	116	3	0	6
Acquisition	32	3	6	9

All the sensors are positioned at critical points of the facility to allow the collection of significant data. In particular:

- DP meters are positioned across all the critical components and piping section of the PbLi loop to measure the contribution to the pressure losses and dynamical behavior of the single components during the in-box LOCA transients.



- Fast pressure transducers will be mounted on the test section and the pipes of the pipe forest. This will allow the detection of pressure spikes inside the TBM mock-up and the measurement of the pressure waves traveling through the piping up to the TEU and recirculation tank.
- Absolute pressure transducers will be mounted on the main tanks (recirculation, TEU, and relief tanks). Their main function will be to acquire data on how these free volumes can absorb and mitigate the pressure wave propagation throughout the system. Moreover, the reading of these sensors is usually less prone to drift than the fast pressure transducers, and thus it can be used as a calibration signal for these latter ones.
- Strain gauges will be mounted inside the test section and on the pipe forest to acquire the deformation of these critical components.
- Thermocouples will be placed both inside the test section and on the piping to acquire possible temperature fluctuations related to the release of energy due to the PbLi–water chemical interaction.
- A hydrogen analyzer will be included in the system. It will be able to spill non-condensable gasses (Ar + H<sub>2</sub>) containing reaction products from all over the facility thanks to a dedicated piping and valve system. This will allow the monitoring of the quantities of hydrogen produced during the in-box LOCA event and the evaluation of the amount of lithium reacted with water.

All these instruments will acquire data at high speed to continuously characterize the dynamic interaction taking place inside the system. The hydrogen analysis procedure will be carried out after the facility has stabilized to its final state. This procedure is challenging, due to the conditions in which the measurement takes place (high temperature and pressure) and due to the presence of molten PbLi in the zones where gases are extracted. However, thanks to the previous experience accumulated from the operation of other facilities, several mitigation solutions have been put in place to avoid disruptions, such as:

- Pre-pressurization of the hydrogen analysis system to avoid sudden suction of material from the facility piping into the hydrogen analysis piping;
- Heat tracing of the whole hydrogen piping to avoid cold spots that might freeze during the procedure;
- Redundancy of the pathways from the various zones of the facility to the hydrogen analyzer to reroute gasses in case of plugging;
- Presence of a separation tank to effectively separate possible residual of PbLi or other materials from the gas before the analysis.

Moreover, the water utilized for the in-box LOCA tests will be supplied through the water loop facility, which will install both mass flow meters and differential pressure meters to have a direct and indirect measurement of the injected water mass and a comparison with the prediction obtained via stoichiometric calculations. Details about these sensors will be included in future publications.

### 3.4.2. Foreseen Upgrades

The violent nature of the phenomena being investigated in the first phase of the experimentation required that the facility would be simplified to make it able to withstand the repeated high loads on its components. For this reason, several components such as the recirculation pump and the cold-trap mock-up have been excluded from the system to avoid damage. However, since the goal of the second phase of the facility operation is testing the performance of the TBS components, several upgrade points have been foreseen to allow the installation of additional equipment.

In particular, the facility includes:

- Two attachment flanges on the lines P-LLL-08 and 09, between the TEU equivalent volume and the recirculation tank. These flanges can be used to attach to the system a mock-up or prototype of the cold trap for performance or design testing.

- A predisposition in the main recirculation tank to allow the insertion of a pump. This would convert the LIFUS5/Mod4 from a stagnant to a circulating PbLi loop and allow effective testing of the components under representative conditions.

Other than this, the mock-up attachment points are predisposed to accommodate a full-scale TBM mock-up, even if for the first tests smaller ones will be used, representing only one or few breeding units. The CAD drawing of the facility with the upgrade points highlighted in red is shown in Figure 4.

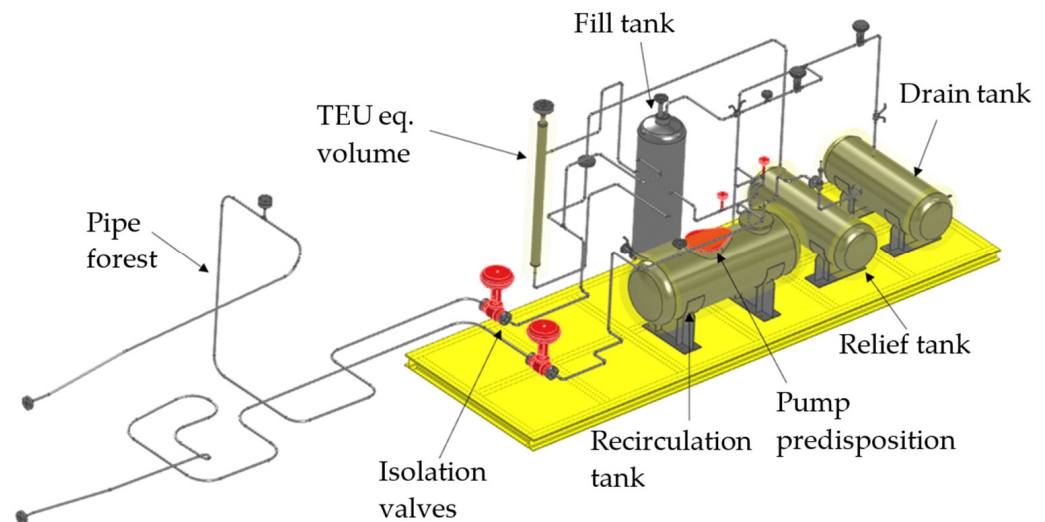

**Figure 4.** LIFUS5/Mod4 preliminary CAD drawing. Highlighted in red: the isolation valves and the upgrade points.

## 4. Facility Operational Modes

### 4.1. Facility States

The facility will have seven main states that can be reached through operator control. These states are:

1. **Cold drained.** In this state the facility is completely shut down, no PbLi is present in the piping and the loop, and all the alloy present in the facility is stored in the loading and draining tanks. The heating wires are shut down throughout the plant except for the loading tank, in which they are kept in a regulation state to avoid alloy solidification. The only valves which are actuated in this state are the electric control valves that keep the pressure inside the loading tank under control.
2. **Hot drained.** In this state, the facility is brought to temperature but PbLi is present only in the loading/draining tanks. This state is reached before the loading of the facility for a test or after a test is completed. All the regulation cables, except for those heating the tanks' draining lines, are on and the control system is regulating the pressure in the loading and draining tanks.
3. **Hot loaded.** In this state, part of the alloy has been transferred to the storage tank and the facility is ready to be filled. Here, the isolation valves are still closed and the PbLi does not fill the piping, TEU, or test section. The control system is regulating the pressure in every zone of the facility.
4. **Hot filled.** This state immediately precedes the test. Here, the facility is filled with alloy, the loading and draining tanks are isolated from the system, and the pressure control system is regulating the pressure in all the zones of the facility.
5. **Test.** In this state, the facility performs the test. The exact state of the facility will depend on the details of the test execution; they will be defined in subsequent phases of the design.
6. **Gas analysis.** This state is reached after the test is completed and the gas analysis phase is taking place. Here, the hydrogen system valves are opened one at a time and

the facility is slowly depressurized by collecting and transporting the gas mixture present inside it to the analyzer.

7. **Acid wash.** This state is a special state in which after returning to the cold-drained state the facility can be cleaned by circulating an acidic solution to dissolve the reaction products.

Before each test, the facility begins in the cold-drained state. The startup procedure consists of bringing the facility to temperature by activating the heating wires and the relative control system and heating all the components. This is performed before PbLi loading to avoid the formation of any plug in the system that would impair facility operation; the relative state is referred as to hot drained.

From this state, PbLi is then loaded into the recirculation tank by applying a suitable pressure differential between this tank and the loading tank. The state reached is called hot loaded. After all the alloy needed for the test has been transferred to the recirculation tank, the loading and draining tank are isolated and the facility is then filled to completeness by applying a pressure differential between the piping system and the recirculation tank. The final state reached before the test is referred to as hot filled.

Right after the filling is complete, the facility will be switched to the test execution state, where the experiments are performed and the data acquired. At the end of each test, the gas analysis phase is begun, where the facility is slowly depressurized. Any gas present in the piping system or the tanks is collected and analyzed to determine the amounts of reaction products generated during the test and infer the amounts of reactants. During this phase, the facility will be flushed a few times with pure argon from the pressurization system to scrub all the hydrogen present in the PbLi loop and any that might have diffused into the alloy or facility components.

Once the analysis phase has been completed, the facility will be unloaded and brought back to the cold-drained state, where it can be either refurbished or repaired by technicians or washed through the acid bath technique. This consists of circulating an acidic solution able to dissolve any Pb or Li oxides and any remaining pure substances throughout the facility.

#### 4.2. Test Execution

Once the facility settles on the “Test” state and the experimenters are ready, the test can begin. The execution follows the steps below:

1. Acquisition system resetting. This step is crucial for allowing the acquisition of quality data since fast pressure transducers are prone to drift over time and need to be reset before each measurement;
2. Injection valve opening. This is the last manual command input from the experimenter; the rest of the test is pre-configured and completely automatic;
3. PbLi–water thermodynamical interaction. During this first phase, the water and the alloy physically interact with each other. Water flashing causes rapid pressure fluctuations and the onset of pressure waves into the piping and the main components are coupled with a temperature drop in the interaction zone;
4. PbLi–water chemical reaction. Being much slower than physical phenomena, the chemical reaction between the two reactants will be delayed. This will, however, cause a temperature and pressure increase inside the system and its effect will depend on the state of the system following the first physical reaction.

During the test, several aspects of the PbLi–water interaction can be investigated. A series of sensors inside the test section will acquire data about the effect of the in-box LOCA on the TBM breeding zone and the surrounding structures. A series of sensors mounted on the piping will study the dynamics of the pressure wave propagation inside the system. Sensors placed on the main components will study the conditions to which they will be exposed during the postulated transients. Finally, since the facility will equip the same safety systems as the real plant, different response actions and safety functions can be tested to minimize the damage possibility.

Each test will differ from the others from the point of view of the conditions and the objectives posed. The complete test matrix for the first-phase operation is shown in Table 3.

**Table 3.** Test matrix.

Test	Mock-up Design	Temperature	Safety Functions
#1	Single breeding unit	300 [°C]	None
#2	Single breeding unit	425 [°C]	None
#3	Single breeding unit	450 [°C]	None
#4	Single breeding unit	$f(\#1, \dots, \#3)$	Safety function 1
#5	Single breeding unit	$f(\#1, \dots, \#4)$	Safety function 2
#6	Single breeding unit	$f(\#1, \dots, \#5)$	Safety function 3
#7	Two units	$f(\#1, \dots, \#6)$	$f(\#4, \dots, \#6)$
#8	Multiple units	$f(\#1, \dots, \#7)$	$f(\#4, \dots, \#7)$

The tests are subdivided into three batches. The first three tests will be performed on mock-ups representing the single breeding unit, and they will be performed at varying temperatures. This will allow the investigation of how the different temperatures of the breeding zone affect the phenomena occurring during the in-box LOCA.

The subsequent three tests (#4 to #6) will instead be performed on the same single breeding unit but implementing different types of safety functions. The temperature of the breeding unit during these tests will be determined based on the results of previous tests. This will be performed to study the effect of the various safety functions on the TBM response and the individuation of the best one to maximize its ability to survive during incidental scenarios.

The last two tests will see a significant upgrade and enlargement of the mock-up. This will initially be upgraded to a mock-up containing two breeding units, connected by a collector such as in the real system. After this, it is foreseen to test either a mock-up composed of several of these slices or even a full TBM mock-up, depending on the capability to manufacture it or the actual need to do so. These last two tests will be performed at a temperature determined based on the previous test and with the safety functions chosen from the results of tests #4 to #6.

#### 4.3. Future Operation

As mentioned before, after the initial testing campaign on the TBM in-box LOCA events, the facility is foreseen to be reconfigured into a generic test stand for component qualification and performance evaluation. The main difference with the previous configuration is that the loop will be converted from a stagnant to a circulating one via the installation of a recirculation pump on the main storage tank. Once the loop is upgraded, several possibilities will be opened for future experimentations, such as:

- Converting the facility to a source of flowing PbLi, which, in conjunction with the other facilities of the Brasimone RC, would allow the qualification of the TBM or other WCLL breeding blanket designs for future reactors. This would allow testing the components at their actual working conditions.
- Including in the facility PbLi-based components that need a complete performance evaluation, such as the cold trap and its related auxiliary systems or an actual TEU mock-up.

## 5. Conclusions

Despite being one of the best candidates to solve the issue of tritium breeding and power conversion in future fusion reactors, WCLL technology poses several challenges that need to be addressed before its safe and reliable implementation in these systems. The main issue with WCLL BB lies in the simultaneous presence of high-pressure and temperature water and molten PbLi alloys in the component. This coexistence calls for a thorough evaluation of the response of the system to incidental scenarios in which

the two fluids might come into contact. This is due primarily to their ability to interact both thermodynamically (through flashing and vaporization) and chemically (through the oxidation of lithium by water).

Several experimental campaigns have already been performed on the existing LIFUS5/Mod3 facility, with the main aim of studying the thermodynamic and chemical behavior of the interaction between the fluids.

However, the LIFUS5/Mod3 being a separate effect facility, the response of the system was always decoupled from the dynamical behavior of the structures and that of the rest of the circuit. For this reason, a new version of the facility, called LIFUS5/Mod4, is being designed and built at ENEA Brasimone RC, which will allow the study of the coupled dynamics of the systems.

To attain this goal, the LIFUS5/Mod4 is being designed to be a 1:1 thermohydraulic reproduction of the ITER WCLL TBS PbLi loop. This means that the lines' length, volume, and overall pressure loss will be kept as similar as possible to the ones in the real system, to accurately study their effect on the dynamics of an in-box LOCA event.

Currently, the project has finalized its conceptual design and is advancing through its final design phase. PFD, P&ID, and CAD drawings of the facility are available and procurement of the ancillary system has begun. All the design phases are being supported by extensive numerical analysis work, focusing on the prediction of the thermohydraulic behavior of the facility. Various simulations using the coupled SIMMER/RELAP5-Mod3.3 are ongoing to analyze the facility response to in-box LOCA tests. The produced results will be used to choose the right sensor placement to produce significant data able to capture the main features of the underlying phenomena. In the future months, the design will be adapted to more recent updates on the layouts of the system, allowing the beginning of the engineering design phase. Construction is foreseen between the years 2023 and 2024, to begin the first tests by late 2024.

**Author Contributions:** Conceptualization, A.C., A.D.N., M.E. and N.B.; methodology, N.B., M.E. and A.D.N.; software, N.B.; validation, N.B., M.E. and A.D.N.; formal analysis, N.B.; investigation, N.B., M.E. and A.D.N.; resources, A.D.N. and A.C.; data curation, N.B. and A.C.; writing—original draft preparation, N.B.; writing—review and editing, N.B., M.E., A.D.N. and A.C.; visualization, N.B.; supervision, A.C. and A.D.N.; project administration, A.D.N.; funding acquisition, A.D.N. and A.C. All authors have read and agreed to the published version of the manuscript.

**Funding:** This work has been carried out within the framework of the EUROfusion Consortium, funded by the European Union via the Euratom Research and Training Programme (Grant Agreement No. 101052200—EUROfusion). Views and opinions expressed are, however, those of the author(s) only and do not necessarily reflect those of the European Union or the European Commission. Neither the European Union nor the European Commission can be held responsible for them.

**Institutional Review Board Statement:** Not applicable.

**Informed Consent Statement:** Not applicable.

**Data Availability Statement:** Data sharing is not applicable to this article.

**Conflicts of Interest:** The authors declare no conflict of interest. The funders had no role in the design of the study; in the collection, analyses, or interpretation of data; in the writing of the manuscript; or in the decision to publish the results.

## References

1. Boccaccini, L.V.; Arbeiter, F.; Arena, P.; Aubert, J.; Bühler, L.; Cristescu, I.; del Nevo, A.; Eboli, M.; Forest, L.; Harrington, C.; et al. Status of Maturation of Critical Technologies and Systems Design: Breeding Blanket. *Fusion Eng. Des.* **2022**, *179*, 113116. [[CrossRef](#)]
2. Arena, P.; Del Nevo, A.; Moro, F.; Noce, S.; Mozzillo, R.; Imbriani, V.; Giannetti, F.; Edemetti, F.; Froio, A.; Savoldi, L.; et al. The DEMO Water-Cooled Lead–Lithium Breeding Blanket: Design Status at the End of the Pre-Conceptual Design Phase. *Appl. Sci.* **2021**, *11*, 11592. [[CrossRef](#)]

3. Aubert, J.; Aiello, G.; Alonso, D.; Batal, T.; Boullon, R.; Burles, S.; Cantone, B.; Cismondi, F.; Del Nevo, A.; Maqueda, L.; et al. Design and Preliminary Analyses of the New Water Cooled Lithium Lead TBM for ITER. *Fusion Eng. Des.* **2020**, *160*, 111921. [[CrossRef](#)]
4. Del Nevo, A.; Martelli, E.; Agostini, P.; Arena, P.; Bongiovì, G.; Caruso, G.; di Gironimo, G.; Di Maio, P.A.; Eboli, M.; Giammusso, R.; et al. WCLL Breeding Blanket Design and Integration for DEMO 2015: Status and Perspectives. *Fusion Eng. Des.* **2017**, *124*, 682–686. [[CrossRef](#)]
5. Tassone, A.; Del Nevo, A.; Arena, P.; Bongiovì, G.; Caruso, G.; Di Maio, P.A.; di Gironimo, G.; Eboli, M.; Forgione, N.; Forte, R.; et al. Recent Progress in the WCLL Breeding Blanket Design for the DEMO Fusion Reactor. *IEEE Trans. Plasma Sci.* **2018**, *46*, 1446–1457. [[CrossRef](#)]
6. Martelli, E.; Del Nevo, A.; Arena, P.; Bongiovì, G.; Caruso, G.; Di Maio, P.A.; Eboli, M.; Mariano, G.; Marinari, R.; Moro, F.; et al. Advancements in DEMO WCLL Breeding Blanket Design and Integration. *Int. J. Energy Res.* **2018**, *42*, 27–52. [[CrossRef](#)]
7. Eboli, M.; Moghanaki, S.K.; Martelli, D.; Forgione, N.; Porfiri, M.T.; Del Nevo, A. Experimental Activities for In-Box LOCA of WCLL BB in LIFUS5/Mod3 Facility. *Fusion Eng. Des.* **2019**, *146*, 914–919. [[CrossRef](#)]
8. Eboli, M.; Crugnola, R.M.; Cammi, A.; Khani, S.; Forgione, N.; Del Nevo, A. Test Series D Experimental Results for SIMMER Code Validation of WCLL BB In-Box LOCA in LIFUS5/Mod3 Facility. *Fusion Eng. Des.* **2020**, *156*, 111582. [[CrossRef](#)]
9. Eboli, M.; Galleni, F.; Forgione, N.; Badodi, N.; Cammi, A.; Del Nevo, A. Experimental and Numerical Results of LIFUS5/Mod3 Series E Test on In-Box LOCA Transient for WCLL-BB. *Energies* **2021**, *14*, 8527. [[CrossRef](#)]
10. Eboli, M.; Forgione, N.; Del Nevo, A. Assessment of SIMMER-III Code in Predicting Water Cooled Lithium Lead Breeding Blanket “in-Box-Loss of Coolant Accident”. *Fusion Eng. Des.* **2021**, *163*, 112127. [[CrossRef](#)]
11. Galleni, F.; Khani Moghanaki, S.; Forgione, N.; Paci, S.; Eboli, M.; Del Nevo, A. SIMMER Codes Post-Test Validation Activity Based on LIFUS5/Mod3 Experiments for PbLi-Water Interaction. In Proceedings of the 19th International Topical Meeting on Nuclear Reactor Thermal Hydraulics, Virtual Event, 6 March 2022. NURETH-19, No. 35785.
12. Badodi, N.; Eboli, M.; Del Nevo, A.; Martelli, D.; Cammi, A. Experimental Results of LIFUS5/Mod3 Tests D1 for SIMMER-III Code Validation. In Proceedings of the 19th International Topical Meeting on Nuclear Reactor Thermal Hydraulics, Virtual Event, 6 March 2022. NURETH-19, No. 35470.
13. Tarallo, A.; Mozzillo, R.; Walcz, E.; Lesko, B.; Tincani, A. *Detail Model of the WCLL-TBS Ancillary Systems, ENEA-WIGNER, EFDA\_D\_2PA9XE v1.0-PMI-7.1.2.Phase II—Task 2 DeSign-T004-D001 (D2.4)*; 202AD. Available online: <https://idm.euro-fusion.org/default.aspx?uid=2PA9XE> (accessed on 15 September 2020).
14. Arena, P.; Oron-Carl, M.; Mitrovic, T. Design Activities of the Water Loop Facility (2PYH89 v1.2), BB-T.04.04-T001-D001. 2022.
15. Eboli, M.; Del Nevo, A.; Forgione, N.; Giannetti, F.; Mazzi, D.; Ramacciotti, M. Experimental Characterization of Leak Detection Systems in HLM Pool Using LIFUS5/Mod3 Facility. *Nucl. Technol.* **2020**, *206*, 1409–1420. [[CrossRef](#)]
16. Eboli, M.; Del Nevo, A.; Forgione, N.; Porfiri, M.T. Post-Test Analyses of LIFUS5 Test#3 Experiment. *Fusion Eng. Des.* **2017**, *124*, 856–860. [[CrossRef](#)]
17. Moscardini, M.; Galleni, F.; Pucciarelli, A.; Eboli, M.; Del Nevo, A.; Paci, S.; Forgione, N. Thermo-Hydraulic Analysis of PbLi Ancillary System of WCLL TBM Undergoing in-Box LOCA. *Fusion Eng. Des.* **2021**, *168*, 112614. [[CrossRef](#)]
18. Lucca, F.; Oron-Carl, M.; Mitrovic, T. Feasibility Study of a Magnet System Coupled with LIFUS5/Mod4 Facility, (2PX2FB v1.0), BB-TBM—S.02.02-T001-D006. 2022. Available online: <https://idm.euro-fusion.org/default.aspx?uid=2PX2FB> (accessed on 31 August 2022).
19. Tassone, A.; Caruso, G. Computational MHD Analyses in Support of the Design of the WCLL TBM Breeding Zone. *Fusion Eng. Des.* **2021**, *170*, 112535. [[CrossRef](#)]
20. Tincani, A. Final Version of PFDs (WCS, CPS, PbLi Loop, TRS). EFDA\_D\_2NQ9ML v1.3-PMI-7.1.2.Phase II—Task 2 Design-T002-D001 (D2.2.1). 2020. Available online: <https://idm.euro-fusion.org/default.aspx?uid=2NQ9ML> (accessed on 10 April 2020).
21. Tincani, A.; Utili, M.; Di Maio, P.A.; Arena, P.; Bruzzone, M.M.; Ciurlini, C. Final Version of PFDs (WCS, CPS, PbLi Loop, TRS) and Main Components Sizing, ENEA\_WIGNER\_CCFE, EFDA\_D\_2NW57H v1.3-PMI-7.1.2.Phase II—Task 2 Design-T002-D001 (D2.2.2). 2020. Available online: <https://idm.euro-fusion.org/default.aspx?uid=2NW57H> (accessed on 10 April 2020).
22. Del Nevo, A.; Caruso, G.; Tincani, A.; Giannetti, F.; Ciurlini, C. Thermohydraulic Analyses of WCS, CPS, Pb-Li Loop, TRS: Methodology and Results, EFDA\_D\_2NQDU5 v1.1-PMI-7.1.2.Phase II—Task 3 Analys-T001-D001 (D3.1). 2020. Available online: <https://idm.euro-fusion.org/default.aspx?uid=2NQDU5> (accessed on 30 May 2020).
23. Galleni, F.; Moscardini, M.; Eboli, M.; Del Nevo, A.; Martelli, D.; Forgione, N. Preliminary Analysis of an In-Box LOCA in the Breeding Unit of the WCLL TBM for the ITER Reactor with SIMMER-IV Code. *Fusion Eng. Des.* **2021**, *169*, 112472. [[CrossRef](#)]

**Disclaimer/Publisher’s Note:** The statements, opinions and data contained in all publications are solely those of the individual author(s) and contributor(s) and not of MDPI and/or the editor(s). MDPI and/or the editor(s) disclaim responsibility for any injury to people or property resulting from any ideas, methods, instructions or products referred to in the content.