

Titolo

Review stato programma Halden Project e definizione linee di R&S di interesse nazionale

Descrittori
Tipologia del documento: Rapporto Tecnico

Collocazione contrattuale: Accordo di programma ENEA-MSE: tema di ricerca "Nuovo nucleare da fissione"

Argomenti trattati: Energia Nucleare, Combustibile e materiali, Strumentazione e Controllo

Sommario

Il rilancio della partecipazione italiana al "Halden Reactor Project" dell'OECD-NEA, centro internazionale di eccellenza nel dominio Fuel&Materials e Instrumentation and Control, è nell'intento di ricostituire/sviluppare competenze nei due specifici settori, a supporto del licensing ed esercizio dei reattori LWR di III Generazione che, nella prospettiva pre-Fukushima e referendum del giugno 2011, il programma nucleare nazionale prevedeva essere installati in Italia nel corso dei prossimi 20 anni.

Temi di particolare attenzione sono il comportamento del combustibile e materiali strutturali in condizioni di alto burn-up e lunghi tempi di residenza in reattore, insieme alle tecnologie di Instrumentation&Control.

I due deliverables previsti (LP1.C1 e LP1.C2), sono raccolti in quest'unico documento congiunto ENEA-POLIMI-U-Pisa (GRNSPG), che fa il review dello stato attuale insieme alla definizione di alcune linee di R&S di possibile interesse nazionale, riferite essenzialmente ai reattori LWR evolutivi, rispettivamente per il Fuel&Materials e Instrumentation &Control. Il documento include la proposta ENEA di riapertura della Partecipazione al Programma Halden Project che precede i due contributi POLIMI e Università di Pisa.

Note:

Rapporto relativo al lavoro svolto in collaborazione ENEA-Politecnico di Milano-Università di Pisa_SPG, deliverables LP1-C1 e C2 della linea progettuale LP1- C "Partecipazione Halden Project" dell'AdP ENEA-MSE, PAR 2008-09 "Nuovo Nucleare da Fissione".

Autori: F. Vettrai¹, L. Luzzi², A. Cammi², M. Adorni³, F. D'Auria³

1) ENEA Bologna 2) CIRTEN POLIMI 3) CIRTEN UNIPIS

2			NOME			
			FIRMA			
1			NOME			
			FIRMA			
0	EMISSIONE	19.9.2011	NOME			
			FIRMA	F. Vettrai	M. Sepielli	P. Meloni
REV.	DESCRIZIONE	DATA	REDAZIONE	CONVALIDA	APPROVAZIONE	

AdP ENEA-MSE PAR 2008-09

Nuovo Nucleare da Fissione

LP1. C – Partecipazione Halden Project

Review stato programma Halden Project e definizione linee di R&S di interesse nazionale

Il rilancio della partecipazione italiana al “Halden Reactor Project” dell’OECD-NEA, centro internazionale di eccellenza nel dominio *Fuel&Materials* e *Instrumentation and Control*, è nell’intento di ricostituire/sviluppare competenze nei due specifici settori, a supporto del licensing ed esercizio dei reattori LWR di III Generazione che, nella prospettiva pre-Fukushima e referendum del giugno 2011, il programma nucleare nazionale prevedeva essere installati in Italia nel corso dei prossimi 20 anni.

Temi di particolare attenzione sono il comportamento del combustibile e materiali strutturali in condizioni di alto *burn-up* e lunghi tempi di residenza in reattore, insieme alle tecnologie di *Instrumentation&Control*.

I due deliverables previsti (LP1.C1 e LP1.C2), sono raccolti in quest’unico documento congiunto ENEA-POLIMI-U-Pisa (GRNSPG), che fa il review dello stato attuale insieme alla definizione di alcune linee di R&S di possibile interesse nazionale, riferite essenzialmente ai reattori LWR evolutivi, rispettivamente per il *Fuel&Materials* e *Instrumentation &Control*. Il documento include la proposta ENEA di riapertura della Partecipazione al Programma Halden Project che precede i due contributi POLIMI e Università di Pisa.

F. Vettrano, ENEA-Bologna

Settembre, 2011

CONTENUTO

- I. PROPOSTA DI RILANCIO DELLA PARTECIPAZIONE ITALIANA AL PROGRAMMA HALDEN PROJECT (ENEA)**
- II. Identificazione di programmi di R&S di interesse nazionale a supporto dei reattori LWR evolutivi, nei settori Fuel&Materials e Instrumentation&Control (POLITECNICO DI MILANO)**
- III. POTENZIALITÀ DEL REATTORE HALDEN: POSSIBILITÀ SIMULAZIONE DI INCIDENTI TIPO LOCA E RIA (UNIVERSITA' DI PISA_SPG)**

PARTE I

Proposta di
**PARTECIPAZIONE ENEA AL PROGRAMMA INTERNAZIONALE OECD – NEA
HALDEN REACTOR PROJECT (HRP)PER IL TRIENNIO 2009–2011 - Annualità
2011 (ENEA)**

- 1. PREMESSA**
- 2. OBIETTIVI DEL HRP**
- 3. ORGANIZZAZIONE DEL PROGETTO**
- 4. AREE DI ATTIVITÀ**
- 5. PARTECIPANTI**
- 6. FINANZIAMENTO**
- 7. MOTIVAZIONI DELLA PARTECIPAZIONE ITALIANA**
- 8. INTERESSI NAZIONALI E E OBIETTIVI**
- 9. MODALITÀ DI PARTECIPAZIONE E COSTI**
- 10. CONCLUSIONI**

PARTE II

Identificazione di programmi di R&S di interesse nazionale a supporto dei reattori LWR evolutivi, nei settori Fuel&Materials e Instrumentation&Control (POLITECNICO DI MILANO)

Executive Summary	
1 INTRODUCTION	
1.1 The Halden Boiling Water Reactor	
1.2 The Halden Reactor Project Programme	
2 STATUS OF RESEARCH IN THE FUELS & MATERIALS AREA (Item C1)	
2.1 R&D issues concerning evolutionary LWRs	
2.2 Selected items from the HRP fuels sub-programme	
2.3 Selected items from the HRP materials sub-programme	
3 STATUS OF RESEARCH IN THE INSTRUMENTATION & CONTROL AREA (Item C1)	
3.1 R&D issues concerning evolutionary LWRs	
3.2 Selected results	
4 R&D PERSPECTIVES OF INTEREST FOR A NATIONAL PROGRAMME (Item C2)	
4.1 Fuels & Materials area.....	
4.2 Instrumentation & Control area	
ACRONYMS.....	

PARTE III

POTENZIALITÀ' DEL REATTORE HALDEN: POSSIBILITÀ' SIMULAZIONE DI INCIDENTI TIPO LOCA E RIA (UNIVERSITA' DI PISA_SPG)

1. Introduzione
2. Descrizione del reattore Halden
 - 2.1. Informazioni generali
 - 2.2. Sistema "reattore"
 - 2.3. Configurazione del core
 - 2.4. Stato dell'impianto
3. Programma di test del combustibile nucleare
 - 3.1. Condizioni normali di funzionamento
 - 3.2. Condizioni incidentali
4. Fenomeni e processi rilevanti per incidenti tipo LOCA
5. Fenomeni e processi rilevanti per incidenti tipo RIA
6. Proposta di un programma sperimentale interesse nazionale
7. Conclusioni

PARTE I

**Proposta di
PARTECIPAZIONE ENEA AL PROGRAMMA INTERNAZIONALE OECD – NEA
HALDEN REACTOR PROJECT (HRP) PER IL TRIENNIO 2009–2011 - Annualità
2011 (ENEA)**

Proposta di

**PARTECIPAZIONE ENEA
AL PROGRAMMA INTERNAZIONALE
OECD – NEA HALDEN REACTOR PROJECT (HRP)
PER IL TRIENNIO 2009–2011 - Annualità 2011**

(Allegato all'Ordinanza Commissariale)

F. Vettrai, ENEA-Bologna

11 Aprile 2011

PREMESSA

Il programma di ricerca e sperimentazione **Halden Reactor Project (HRP)** costituisce uno dei più importanti progetti di R&S sul Nucleare da Fissione promossi dalla OECD-NEA (Nuclear Energy Agency), avviato nel 1958 nell'ambito di un accordo internazionale di collaborazione tecnologica incentrato sulla sicurezza dei reattori nucleari ed in particolare sugli studi e ricerche sul combustibile, i materiali di nocciolo e circuito primario, insieme alla conduzione di attività sperimentali per il miglioramento dei sistemi di controllo reattore.

I programmi-progetti internazionali promossi dalla OECD-NEA, sono mirati a dare risposta a questioni rilevanti per la comunità nucleare attraverso un'attività di ricerca comune svolta da tutti i Paesi aderenti. Essi permettono di migliorare l'interscambio tecnico-scientifico e la cooperazione internazionale, sostengono la continuità operativa di impianti sperimentali ritenuti di interesse primario per la comunità nucleare dei Paesi membri, e supportano il mantenimento dell'esperienza e delle infrastrutture strategiche per l'energia nucleare, facilitando il raggiungimento di risultati comuni attraverso la condivisione dei costi fra i partecipanti. Essi forniscono, inoltre, l'opportunità di accesso a tutte le conoscenze sul nucleare oggetto del Programma Triennale comune (Joint Programme), in un contesto internazionale mirato alla promozione di ulteriori collaborazioni, acquisizioni e miglioramento di conoscenze.

Il Programma è strutturato su due aree principali, *Fuel and Materials* e *MTO (Man Technology Organization)*, lo sviluppo delle cui attività si avvalgono di facilities fondamentali quali il reattore HBWR (Halden Boiling Water Reactor), HAMMLAB (Halden Man Machine Laboratory) e HVRC (Halden Virtual Reality Center), del centro di ricerca di Halden in Norvegia, situato circa 100 chilometri a sud di Oslo.

HRP è cresciuto storicamente intorno al reattore internazionale di ricerca HBWR e utilizzato sin dagli anni '60 per la sperimentazione dei diversi tipi di combustibile nucleare e materiali destinati alle diverse tipologie di reattori esistenti. Il reattore, della potenza massima di 25 MWt, è moderato ad acqua pesante e refrigerato ad acqua bollente, alla pressione di 33,3 bar ed una temperatura di uscita di 240 °C, è collocato all'interno di un tunnel scavato in una formazione rocciosa di granito tipico della Scandinavia, non lontano da una grande cartiera alla quale fornisce una parte rilevante del calore di processo sotto forma di vapore.

Per l'Italia che ha deciso di rilanciare concretamente l'opzione nucleare, con l'obiettivo di mettere in servizio la prima centrale nucleare all'orizzonte 2020, la riapertura della partecipazione al Halden Reactor Project permetterà di avvalersi dell'esperienza di un Centro internazionale di eccellenza nel dominio *Fuel&Materials* e *Instrumentation and Control*, a supporto dell'esercizio sicuro ed efficace, e ancor prima del licensing, dei reattori di III Generazione attesi essere installati nel Paese nel corso dei prossimi dieci-vent'anni.

L'Italia ha partecipato stabilmente a HRP dalle origini fino all'inizio degli anni '90 quando la partecipazione fu interrotta in conseguenza degli effetti del referendum del novembre del 1987. La partecipazione fu ripresa verso la metà degli anni '90 e terminata nuovamente a fine 2002.

OBIETTIVI DEL HRP

L'obiettivo primario del Halden Reactor Project è quello di produrre e trasferire conoscenze, dati, risultati e prodotti rilevanti per l'esercizio sicuro ed efficiente degli impianti nucleari, ivi incluso gli aspetti di maintenance e decommissioning, attraverso la collaborazione di una ampia comunità internazionale, condotta e sviluppata sulla base della ripartizione dei costi fra partecipanti.

ORGANIZZAZIONE DEL PROGETTO

Il Progetto opera sulla base di un Programma Comune triennale - Joint Programme - , sottoscritto dai partecipanti, sotto gli auspici della OECD-NEA (Nuclear Energy Agency). Il programma tecnico-scientifico è definito in accordo a criteri prioritari concordati dalle stesse organizzazioni partecipanti. L'esecuzione del Programma viene monitorato dal Halden Programme Group (HPG) che si riunisce due volte l'anno e da un Board internazionale, Halden Board of Management (HBM), che si riunisce due volte l'anno anch'esso. I risultati sono trasferiti ai partecipanti sotto forma di reports, data files e computer programs.

La partecipazione al HRP avviene come Paese Membro (Member Party) o Associated Party.

E' prevista, tuttavia, anche la possibilità di partecipazioni bilaterali con quei Paesi o organizzazioni che possono avere esigenze specifiche da perseguire al di fuori del Joint Programme.

L'invio di personale tecnico-scientifico dei paesi/organizzazioni partecipanti, a lavorare direttamente presso il Progetto, attraverso la formula del "secondement", favorisce la formazione e il trasferimento delle conoscenze sviluppate.

AREE DI ATTIVITÀ

Il Progetto opera su due aree di attività, *Fuel&Materials* e *MTO*, ove gli scopi principali perseguiti sono:

Fuel and Materials

- Fuel safety and reliability under normal operation conditions
- Fuel behavior under demanding operation conditions
- Operational margins
- Fuel behavior under accident scenarios
- Innovative fuels
-
- Plant aging issues
- Internals irradiation assisted stress corrosion cracking
- Creep and stress relaxation of in-vessel materials
- Pressure vessel integrity studies

Man-Technology-Organization

- Human reliability
- Human and organizational factors (includes decommissioning)
- Control center design and evaluation
- Outage and field work, including decommissioning
-
- Software systems dependability
- Operational support of digital system
- Condition monitoring and maintenance support

PARTECIPANTI

E' attualmente in corso il Programma triennale 2009-11 che vede la partecipazione di 18 Paesi, con in testa quelli più industrializzati nei quali l'energia nucleare rappresenta una realtà di dimensioni rilevanti (Tab.1). I Paesi Membri (*Member Parties*) sono, oltre alla Norvegia, Stati Uniti, Giappone, Francia, Germania, Regno Unito, Spagna, Belgio, Danimarca, Finlandia, Svezia, Svizzera, Corea del Sud, Russia, Ungheria, Rep. Ceca, Slovacchia e Kazakistan. Ai Paesi Membri si aggiunge un numero di istituzioni pubbliche e private, dell'industria e della ricerca, di vari paesi (*Associated Parties*).

FINANZIAMENTO

Il budget totale, per il triennio 2009-2011 (v. Tab. 2), ammonta a 374.7 milioni di NOK (circa 44.4 milioni di Euro) di cui 317.1 milioni di NOK provengono dai Paesi membri e 57.6 milioni di NOK dagli *Associated Parties*. La Norvegia, come Paese Membro, contribuisce con 132 Milioni NOK (35% del totale).

MOTIVAZIONI DELLA PARTECIPAZIONE ITALIANA

Il rilancio dell'opzione nucleare in Italia riporta in primo piano l'interesse e necessità a partecipare a programmi internazionali come HRP al fine di ricostituire le condizioni per lo sviluppo delle competenze in settori importanti come il *Fuel&Materials* e *Instrumentation and Control*. In accordo a quanto riportato nell'AdP ENEA-MSE (PAR 2008-09), "il rilancio della partecipazione italiana al Halden Reactor Project permetterà di avvalersi dell'esperienza di un Centro internazionale di eccellenza nel dominio *Fuel&Materials* e *Instrumentation and Control*, a supporto dell'esercizio sicuro ed efficace dei reattori attuali e futuri. Temi di particolare attenzione sono il comportamento del combustibile e materiali strutturali in condizioni di alto *burn-up* e lunghi tempi di residenza in reattore, insieme alle tecnologie digitalizzate *Man Machine Interface* (MMI) per il controllo reattore. La partecipazione offre anche l'opportunità di scuola/training per giovani ricercatori, insieme a quella di agire quale riferimento di base per lo sviluppo di un simulatore ingegneristico in ENEA".

La partecipazione ad HRP è attesa avere, pertanto, ricadute benefiche sia sul processo di formazione delle nuove risorse umane di cui il programma nucleare nazionale ha bisogno, nonché sul ruolo di possibile TSO (Technical Support Organization) nei confronti dell'Autorità di Sicurezza Nucleare, che l'ENEA prevede di poter svolgere.

INTERESSI NAZIONALI E E OBIETTIVI

In accordo a quanto sopra riportato, l'interesse nazionale al rilancio della partecipazione italiana ad Halden Project per il 2011, è rivolto ai seguenti obiettivi prioritari:

Area Fuel&Materials

- Stato su progettazione, comportamento e prestazioni del combustibile nucleare e materiali strutturali in condizioni operative rilevanti per i reattori LWR di III Generazione.
- Definizione di linee di analisi, ricerca e sviluppo di più specifico interesse nazionale a supporto dei reattori LWR III Generazione (EPR, AP1000), e in particolare.
 - o combustibili UOX ad alto arricchimento e MOX per l'alto burn-up (>60 MWd/kg), combustibili e materiali di guaina innovativi, risposta del combustibile in condizioni di alto burnup, in regime di *funzionamento normale e incidentale*
 - o comportamento dei materiali strutturali in corso di vita (ageing effect)
 - o modelli di fuel rod design and performance
 - o aspetti di back-end del ciclo combustibile (tecniche innovative di gestione e smaltimento del combustibile irraggiato e dei rifiuti nucleari, caratterizzazione, processi di trattamento e condizionamento, trasporto di materiali nucleari, progetto concettuale del deposito e sitologia, analisi di sicurezza, addestramento degli operatori con tecniche avanzate di simulazione)

Area MTO (Instrumentation&Control)

- Review generale riguardanti lo stato dell'arte dell' *Instrumentation and Control*
- Definizione di linee di analisi, ricerca e sviluppo di più specifico interesse nazionale, tra cui:
 - o Nuovi requisiti per la sensoristica, la strumentazione e controllo derivanti dalle caratteristiche della nuova generazione di reattori nucleari (evolutivi/ innovativi)
 - o Sistema di automazione, controllo e supervisione avanzati (controllo remotizzato e supervisionato da sale manovra digitali e multi-unità)
 - o Utilizzo delle tecnologie di Realtà Virtuale per la progettazione, pianificazione delle attività di manutenzione, visualizzazione del processo, simulazione e addestramento degli operatori.
 - o Supporto allo sviluppo di un Simulatore ingegneristico di reattori evolutivi LWR in ENEA

MODALITÀ DI PARTECIPAZIONE E COSTI

Le risorse finanziarie disponibili sono quelle previste nell'AdP ENEA-MSE (PAR2008-09) che permettono di riaprire la partecipazione per l'annualità 2011, ultima del Programma 2009-11, sotto la formula di *Associated Partner* e con ipotesi di costo a carico esclusivo ENEA (v. Tab. 3).

Questo nella prospettiva di un consolidamento della partecipazione a partire dal prossimo

Programma triennale 2012-2014, con estensione della stessa ad un *Gruppo di Interesse Nazionale* più allargato che si ritiene debba comprendere, insieme ad ENEA, Università (CIRTEN e possibili altre Università), Industria (Ansaldo N., Mangiarotti Nuclear, SOGIN, RSE SpA, Softeco, Distretto Tecnologico Ligure), Utilities (ENEL), Autorità Sicurezza Nucleare (ASN).

Si prevede che nel corso della partecipazione all'annualità 2011, due ricercatori ENEA, uno per ciascuna delle due aree di attività, possano essere inviati temporaneamente presso HRP sotto la formula del "secondement" e/o quale "in-kind contribution".

CONCLUSIONI

A motivo sia delle significative ricadute tecnologiche che si attendono dalle attività previste dal programma HRP, sia delle opportunità di ulteriori possibili collaborazioni, anche bilaterali con centri di ricerca di altri Paesi membri di HRP, si propone che l'ENEA riprenda la sua partecipazione al programma HRP a partire dal triennio 2009-2011 (ultima annualità) in corso, nella prospettiva di esplorare e preparare le condizioni per la continuità della partecipazione sin dal prossimo triennio 2012-2014.

Tab. 1 - Halden Project Participants (2009- 2011)

• Norway	IFE - Institutt for energiteknikk
• Belgium	SCK/CEN - Belgian Nuclear Research Centre
• Denmark	Risø DTU
• Finland	TYÖ – JA ELINKEINO-MINISTERIÖ - Ministry of Employment and Economy, operated by VTT - Includes Finnish utilities
• France	EDF - Electricité de France - IRSN is associated party - CEA membership under discussion
• Germany	GRS - Gesellschaft für Anlagen- und Reaktorsicherheit mbH - Includes German utilities and AREVA
• Japan	JNES - Japan Nuclear Energy Safety Organization Japan Associated Parties - JAEA, Japan Atomic Energy Agency - CRIEPI (incl. Toshiba and 11 utilities) - Mitsubishi Nuclear Fuel (incl. MHI)
• Korea	KAERI - Korean Atomic Energy Research Institute - Includes the Korean utility (KEPCO) and the fuel vendor (KNF)
• Spain	CIEMAT - Centro de Investigaciones Energéticas, Medioambientales y Tecnológicas - Includes the Spanish safety authority (CSN) fuel vendor (ENUSA)
• Sweden	SSM - Swedish Radiation Safety Authority - Includes the Swedish fuel vendor (<u>W</u>) and utilities
• Switzerland	ENSI - Swiss Federal Nuclear Safety Inspectorate - Includes the Swiss utilities and nuclear research centre (PSI)
• UK	NNL – National Nuclear Laboratory - Includes UK utilities and safety authority (Rolls-Royce under discussion)
• USA	US NRC - United States Nuclear Regulatory Commission USA Associated parties: - GE/ GNF - Global Nuclear Fuel - Westinghouse Electric Power Company - EPRI - Electric Power Research Institute - DOE – US Department of Energy
• Czech Rep.	NRI - Nuclear Research Institute, includes Czech utilities and safety authority
• Slovak Rep.	VUJE Slovak Nuclear Power Plant Research Institute, includes Slovak utilities
• Hungary	KFKI Hungarian Academy of Sciences, utilities and safety authority
• Russia	“TVEL” JSC Russian associated parties - Research Centre “Kurchatov Institute”, - Research Institute VNIIAES
• Kazakhstan	Ulba , Fuel manufacturing company

**Tab. 2 - Ripartizione delle spese totali del HRP-Joint Programme
per il periodo 1.1.2009-31.12.2011**

Items	2009	2010	2011	Total
Reactor Plant Operation	32.4	33.4	34.4	100.2
High Burn-Up Fuel Performance	27.7	28.6	29.4	85.7
In-Core Materials & Water Chemistry Effects	12.1	12.6	12.9	37.6
Man, Technology, Organisation (MTO) programme	46.8	48.4	49.5	144.7
Reserves	1.3	2.2	3.0	6.5
SUM	120.3	125.2	129.2	374.7

All amounts in million Norwegian Kroner.

Tab. 3 - Schema Budget Partecipazione ENEA e gruppo Interesse Italia

Organizzazione	Costo Annuale (K€)				Totale Partecipante (K€)
	<u>2011</u>	<u>2012</u>	<u>2013</u>	<u>2014</u>	
ENEA (<i>associated partner</i>)	80	-	-	-	80
Gruppo Interesse Nazionale (<i>associated partner con ENEA</i>) *	-	-	-	-	-
Totale	80	-	-	-	80

* per il 2011 ENEA è partner unico

PARTE II

**Identificazione di programmi di R&S di interesse nazionale a supporto dei reattori LWR evolutivi, nei settori Fuel&Materials e Instrumentation&Control
(*POLITECNICO DI MILANO*)**



CIRTEN

Consorzio Interuniversitario per la Ricerca Tecnologica Nucleare

POLITECNICO DI MILANO

DIPARTIMENTO DI ENERGIA, Sezione INGEGNERIA NUCLEARE-CeSNEF

Identificazione di programmi di R&S di interesse nazionale a supporto dei reattori LWR evolutivi, nei settori Fuel&Materials e Instrumentation&Control

L. Luzzi, A. Cammi

CERSE-POLIMI RL-1352/2011

Milano, settembre 2011

*Lavoro svolto in esecuzione della linea progettuale LP1- punto C1+C2
AdP MSE - ENEA "Ricerca di Sistema Elettrico" - PAR2008-09
Progetto 1.3 - "Nuovo Nucleare da Fissione".*



INDEX

Executive Summary.....	3
1 INTRODUCTION.....	5
1.1 The Halden Boiling Water Reactor.....	5
1.2 The Halden Reactor Project Programme.....	8
2 STATUS OF RESEARCH IN THE FUELS & MATERIALS AREA (Item C1)	13
2.1 R&D issues concerning evolutionary LWRs	13
2.2 Selected items from the HRP fuels sub-programme	14
2.3 Selected items from the HRP materials sub-programme.....	21
3 STATUS OF RESEARCH IN THE INSTRUMENTATION & CONTROL AREA (Item C1)	25
3.1 R&D issues concerning evolutionary LWRs	25
3.2 Selected results.....	25
4 R&D PERSPECTIVES OF INTEREST FOR A NATIONAL PROGRAMME (Item C2)	45
4.1 Fuels & Materials area.....	46
4.2 Instrumentation & Control area.....	52
ACRONYMS.....	55



EXECUTIVE SUMMARY

The Halden Reactor Project (HRP) has been in operation for more than 50 years and is the largest OECD-NEA (Organisation for Economic Cooperation and Development - Nuclear Energy Agency) joint project. It brings together an important international technical network in the areas of nuclear fuel reliability, integrity of reactor internals, plant control/monitoring and human factors. The programme is primarily based on experiments, product developments and analyses carried out at the Halden Boiling Water Reactor (HBWR) in Norway, and is supported by 130 organisations in 18 countries. While offering a stable and well-experienced organisation, the technical infrastructure and the objectives of the Halden Reactor Project have undergone substantial upgrades and continual adaptation to users' needs over the years. The present report focuses on the two following areas of research: Fuels & Materials (F&M), and Instrumentation & Control (I&C). More specifically, within the HRP context, R&D activities in the F&M area include: fuel assessments in postulated accident conditions, investigations in the high and very high burn-up range (both under normal operating conditions and transients), performance analysis of modern Zircaloy materials, plant lifetime assessments related to the reliability of reactor internals materials (e.g., embrittlement and cracking behaviour). As to the R&D activities carried out in the HRP context on plant control and monitoring, they pertain to verification and upgrades of systems for signal validation, performance monitoring, plant diagnostics and support, and alarm handling. The latter belongs to the Human Factor programme, in the more general framework of the Man Technology Organisation (MTO), which is out of the scope of the present report.

*In this report, after a brief introduction about the HBWR and the recent HRP Programmes, the status of research in both the F&M and I&C areas is first presented - **Item C1**. In particular, the most relevant studies carried out during the last HRP Research Programme (2009-2011) are outlined. On this basis, the R&D perspectives of interest for a possible Italian National Programme are therefore briefly discussed, in terms of development and qualification process for both the F&M and I&C areas - **Item C2**. Throughout the report, close reference is made to the issues concerning evolutionary LWRs.*

For the sake of clarity and convenience, the above mentioned HRP Programme in the Fuel & Materials is divided into the fuels sub-programme and the materials sub-programme, and the corresponding issues are reported in a synoptic way. The HRP fuels sub-programme was aimed to determine fuel safety and operational margins for use in design and licensing by studying: (i) gas release behaviour from fuel under irradiation; (ii) fuel thermo-mechanical performance under irradiation at high burn-ups; (iii) fuel behaviour under loss of coolant accident (LOCA) scenarios; and (iv) fuel behaviour under demanding operation conditions, mainly with reference to PCMI (pellet-clad-mechanical-interaction), cladding transient creep, cladding corrosion and hydriding. The investigations concerned fuels in a variety of conditions relevant to operation, licensing and use in Light Water Reactors (PWR, BWR, VVER) - i.e., standard UO₂, MOX, Gd and Cr bearing UO₂ fuel pellets - and M5, ZIRLO, E110 and M-MDA fuel cladding as well as Zircaloy-4 and Zircaloy-2. The HRP materials sub-programme was aimed at contributing to the knowledge of plant ageing and degradation for lifetime extension by: (i) extending the materials database on crack initiation and growth behaviour; (ii) contributing to the understanding of irradiation assisted stress corrosion cracking (IASCC) behaviour; (iii) studying irradiation induced changes in component mechanical behaviour; and (iv) determining the effectiveness of ageing and degradation countermeasures. In the present report, selected items from the HRP materials sub-programme are



presented, according to the following issues: IASCC of BWR and PWR reactor internals material; irradiation enhanced creep and stress relaxation; and reactor pressure vessel embrittlement.

During the 2009-11 HRP Programme, several progresses were achieved also in the Instrumentation & Control area. They mainly concerned: (i) the development of in-core instrumentation for measuring all key parameters for fuel studies, such as fission gas release, fuel temperature, fuel swelling, cladding creep; (ii) the definition of physics-based models for condition monitoring; (iii) the definition of methods for plant-wide sensor validation; (iv) the refinement of ageing and condition-based models for remaining useful life estimation; and (v) cable ageing assessment.



1 INTRODUCTION

In the sequel, a brief introduction on the main features of the Halden Boiling Water Reactor (HBWR) is provided together with a general overview of the Halden Reactor Project (HRP) Programme in both the areas of Fuels & Materials (F&M) and Man Technology Organisation (MTO).

1.1 The Halden Boiling Water Reactor

Reactor site

The Halden Boiling Heavy Water Reactor is located in Halden, a coastal town in south-east Norway near to the border to Sweden. The reactor hall is situated within a rock hillside on the north bank of the river Tista. The size of the reactor site area is 7000 m² (Fig. 1).



Fig. 1. Site area of the BHWR in Halden.

Reactor system

The HBWR is a natural circulation boiling heavy water reactor (Fig. 2). The maximum power is 25 MW (thermal), and the water temperature is 240°C, corresponding to an operating pressure of 33.3 bars. Pressurization tests are performed at regular intervals using a pressure of 40 bars.

The reactor pressure vessel is cylindrical with a rounded bottom. It is made of carbon steel and the bottom and the cylindrical portion are clad with stainless steel. The flat reactor lid has individual penetrations for fuel assemblies, control stations and experimental equipment.

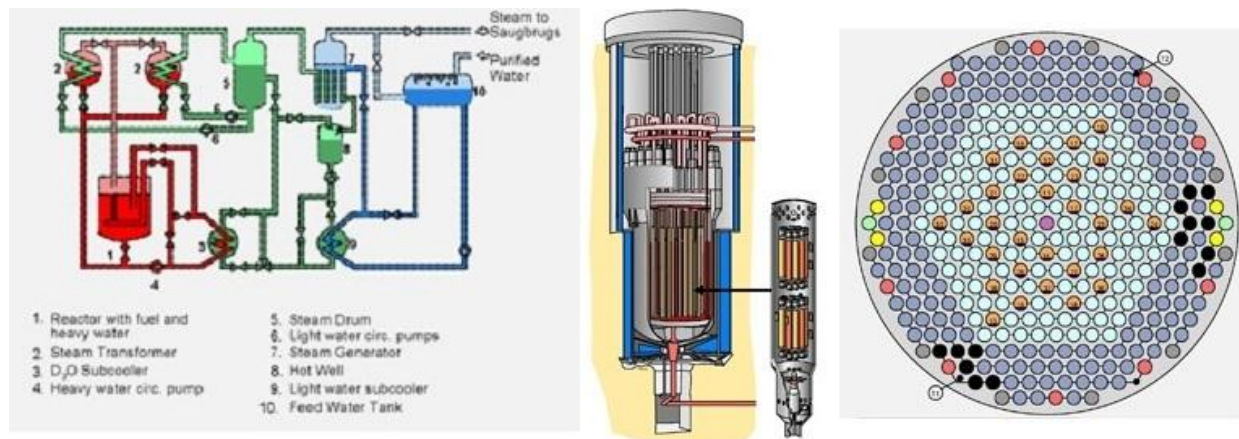

Fig. 2. Simplified flow sheet of the HBWR (on the left), view of the reactor (in the middle) and horizontal section of the core (on the right).

14 tons of heavy water act as coolant and moderator. A mixture of steam and water flows upwards by natural circulation inside the shroud tubes which surround the fuel rods. Steam is collected in the space above the water, while water flows downwards through the moderator and enters the fuel assemblies through the holes in the lower ends of the shroud. The steam flows to two steam transformers where heat is transferred to the light water secondary circuit. Condensate from the steam transformers returns to the reactor by gravity. An external sub-cooler loop is installed to provide experimental variation of void fraction in the fuel assemblies and the moderator, and is also used for heating and cooling purposes.

In the secondary circuit, two circulation pumps pass the water through the steam transformers, a steam drum and a steam generator where steam is produced in the tertiary circuit. The tertiary steam is normally delivered as process steam to the nearby paper mill, but may also be dumped to the river.

There is generally no access to the reactor hall when the reactor is operational, and therefore all control and supervision is carried out from the control room.

Reactor operating conditions

The R&D programme is based on operating the Halden Reactor. A fuel charge consists of a combination of test fuel from organisations in member countries and driver fuel assemblies, which provide reactivity for operating the reactor. Light water, high pressure loops provide facilities for testing under prototypic BWR and PWR conditions. In particular, the HBWR reveals a versatile tool for nuclear fuels and materials investigations, thanks to the following features:

- more than 300 positions individually accessible;
- about 110 positions in central core;



- about 30 positions for experimental purposes (any of 110/300);
- height of active core 80 cm;
- usable length within moderator about 160 cm;
- experimental channel \varnothing :- 70 mm in HBWR moderator, 35-45 mm in pressure flask;
- loop systems for simulation of BWR/PWR conditions.

Core description

The core consists of about 110 - 120 fuel assemblies, including the test fuel, in an open hexagonal lattice with a lattice pitch of 130 mm. 30 lattice positions are occupied by control stations. The maximum height of the fuel section is 1710 mm, and the core is reflected by heavy water.

The central position in the core is occupied by an emergency core cooling tube with nozzles, and between eight and fourteen core positions contain pressure flasks for light water, high pressure test loops.

Currently, each driver fuel assembly consists of eight or nine fuel rods with 6% fuel enrichment and standard fuel pellet diameter.

Plant status

The design working pressure of the HBWR pressure vessel is 40 bar with a saturation temperature of 250°C. The hydraulic acceptance pressure test was carried out at 54 bars, 35% above the design pressure. The normal operating pressure is 33.3 bars, with corresponding saturation temperature of 240°C. The stresses in the vessel are low compared with the code requirements. Thermal stresses are also normally low.

There are normally 2-3 main shutdowns per year, dictated primarily by the experimental programmes, and a few additional cooling downs for special tests. The normal heating and cooling rates are 10°C·h⁻¹. Inspection and recertification pressure tests are performed every 3rd year at 10% overpressure. These pressure tests are performed with water/steam at saturation temperature. According to the requirements set by Norwegian Boiler Authority, the inspection and test programmes include ultrasonic examination of vessel welds, lid, bolts, bottom nozzle and primary system piping, and evaluation of radiation induced material changes.

The bottom nozzle welds and the welds beltline region of the reactor vessel wall are being 100% ultrasonically examined at the inspections. Also the top lid and the flange bolt are being inspected, the bolts 100% by ultrasonic. The primary system piping is subject to inspection by NDT (Non-Destructive Testing) methods. No defect indications in the above mentioned inspections have been found.

The irradiation induced changes in the vessel material are being monitored by material testing every 6th year, flux evaluations and fracture analysis. The Charpy and fracture mechanics test on



surveillance specimens are performed by VTT Laboratory in Finland, using material specimens with appropriate lead factors in fluence. Flux and fluence assessments enable quantification of the fluence received by the different parts of the vessel, account taken of the changing core loading over the years.

The outcome of the material testing, fluence evaluations, inspections, and pressure testing form the basis for the assessments of vessel integrity. Internationally accepted codes, rules and recommendations are used in a consultative manner. The material tests and the analysis performed indicate that the reactor can be operated safely well beyond year 2020.

1.2 The Halden Reactor Project Programme

The Halden Reactor Project (HRP) has been in operation for more than 50 years and is the largest OECD-NEA (Organisation for Economic Cooperation and Development - Nuclear Energy Agency) joint project. More specifically, the HRP is a joint undertaking of national organisations in 18 countries sponsoring a jointly financed research programme, which provides key information for safety assessments and licensing as well as for the reliable operation of nuclear power stations. The international members of the Halden Project (HP) participate actively in formulating, prioritising and following up the research programmes. This ensures that the work is focused on tasks with direct safety relevance. In the execution of the Programme, the Halden Project maintains close contacts with its member organisations in the participating countries and with NEA-OECD and its relevant working groups. A technical steering committee, the Halden Programme Group (HPG), with members from the participating organisations, approves the annual research programme and oversees the progress of the work. The HRP operates by way of three-year renewable mandates (the current mandate runs until the end of 2011). The Programme is using the Halden Boiling Heavy Water Reactor (HBWR), the Halden Man Machine Laboratory (HAMMLAB) and the Halden Virtual Reality Centre (VRC) for both experimental and modelling work. While offering a stable and well-experienced organisation, the technical infrastructure and the project objectives have undergone substantial upgrades and continual adaptation to users' needs over the years.

Participating countries

- Belgium: Nuclear Research Centre (SCK-CEN)
- Czech Republic: Nuclear Research Institute (NRI)
- Denmark: Risø National Laboratory (Risø)
- Finland: Ministry of Trade and Industry
- France: Electricité de France (EdF)





- Germany: Gesellschaft für Reaktorsicherheit (GRS)
- Hungary: Hungarian Academy of Sciences - Atomic Energy Research Institute
- Japan: Japan Atomic Energy Agency (JAEA)
- Kazakhstan: Ulba metallurgical Plant
- Norway: Institutt for Energiteknikk (IFE)
- Republic of Korea: Korea Atomic Energy Research Institute (KAERI)
- Russia: TVEL
- Slovak Republic: Nuclear Power Plant Research Institute (VUJE)
- Spain: Centro de Investigaciones Energéticas, Medioambientales y Tecnológicas
- Sweden: Strålsäkerhetsmyndigheten (Swedish Radiation Safety Authority)
- Switzerland: Federal Nuclear Safety Inspectorate
- United Kingdom: Nexia Solutions; Health and Safety Executive (HSE)
- USA: Office of Nuclear Regulatory Research (at U.S. NRC)

Fuel & Materials (F&M)

The activities in the F&M area provide fundamental knowledge on the properties and behaviour of nuclear fuels and materials under long term use in reactors as well as during transients.

The main goals of the R&D work in the F&M area are to provide data on:

- fuel properties needed for design and licensing of high burn-up reactor fuel;
- fuel response to transients, in particular on phenomena occurring during loss-of-coolant accidents (LOCA);
- cladding creep, corrosion and hydriding to determine mechanisms and operational conditions that affect cladding performance, e.g. water chemistry issues;
- stress corrosion cracking of reactor materials at representative stress conditions and water chemistry environments for plant lifetime assessments.

Man Technology Organisation (MTO)

The research in the MTO area (Fig. 3) comprises empirical studies of the interaction between the reactor operators and the supervision and control systems. It also comprises innovative work on Human System Interface (HSI) design and Control Room design. 3D visualization technologies by means of Virtual and Augmented Reality are being developed by the Visual Interface Technologies (VIT) Division. The VIT Division develops the software infrastructure used to support experiments in HAMMLAB, and it also conducts research on topics related to planning, supporting and training field operators, and other applications of visualisation technologies in the plant lifecycle. This



comprises software designed to support the editing and management of simulated work scenarios in 3D environments (e.g., collaborative training related to safety of work operations).

The MTO research carried out at the Halden Project is based on the Halden Man Machine Laboratory (HAMMLAB). Since its establishment in 1983, HAMMLAB has been a world-wide reference facility for human factor studies and for advices on control room engineering. It provides the basis for studies on the performance of control room operators in complex and automated environments on human factors research and human-computer systems development. HAMMLAB has two advanced and modern nuclear simulators, the HAMBO simulator (BWR, simulates the Forsmark-3 plant in Sweden), and the RIPS simulator (PWR, simulates the Ringhals-3 plant in Sweden). The simulators have capabilities also supporting the proposed programme activities on outages and future plants. HAMMLAB is complemented by the Virtual Reality Centre (VRC) Laboratory, a facility for rapid, interactive, high quality design of control rooms. Tools to assist in verification and validation of such designs as well as tools for maintenance training have been developed.

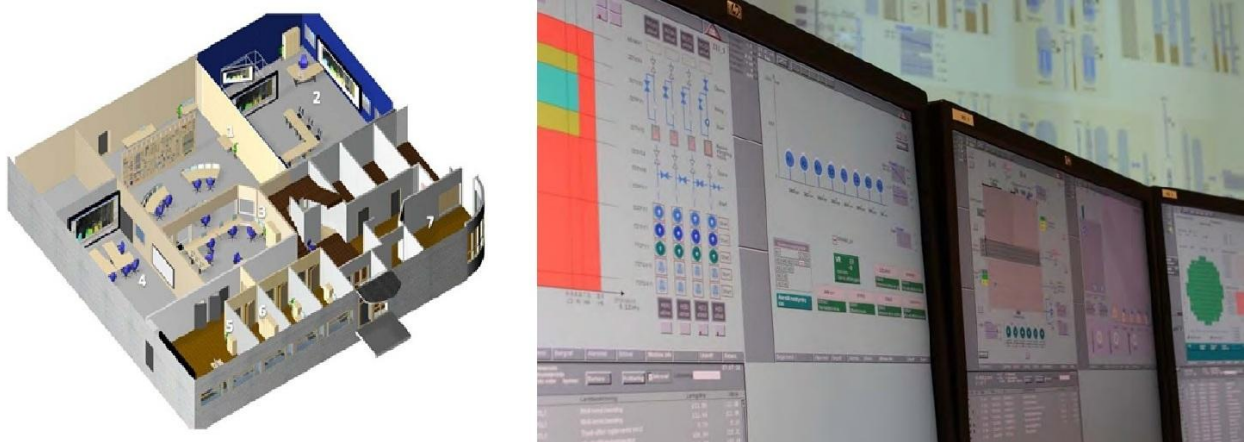

Fig. 3. The 2010 version of the MTO laboratory facilities (on the left): 1. HAMMLAB; 2. VRC Laboratory; 3. Experimenters Gallery; 4. IO (Integrated Operations) Lab; 5. Separate Test and Integration Lab; 6. Future Plant Laboratory; 7. Human Factors Analysis Room. Various HSI prototypes installed and tested in HAMMLAB (on the right).

The main goals of the R&D work in the MTO area are to:

- provide knowledge on how and why accidents occur, with the aim to prevent them from happening;



- establish empirical knowledge about human potentials and limitations as operators in a control room setting based on experiments carried out in HAMMLAB and the VRC Laboratory;
- develop advanced information and support systems for use in plant optimization, operation and maintenance;
- develop methods and tools to improve the dependability of software based systems.

In this report, the most relevant studies carried out during the last HRP Programme (2009-2011) are presented (Item C1) in order to establish the basis for the definition of R&D programmes of possible interest for Italy (Item C2). In particular, close reference is made to the issues concerning evolutionary LWRs, and only the Instrumentation & Control (I&C) issues are considered in the context of the more general MTO area (that is out of the scope of the present report).





2 STATUS OF RESEARCH IN THE FUELS & MATERIALS AREA (ITEM C1)

In this section, the status of research in the Fuels & Materials area is briefly presented, with close reference to the recent HRP Programme (2009-2011) about the most relevant issues of interest for the evolutionary LWRs. In particular, for the sake of clarity and convenience, the above HRP Programme is divided into the fuels sub-programme and the materials sub-programme, and the corresponding issues are reported in a synoptic way. Both these sub-programmes have been built on existing Halden experience and capabilities to produce a variety of test conditions and coolant environments, while making reliable in-reactor measurement (see Section 3) in order to study phenomena on-line and in-situ. The results from the HRP research programme are in detail reported to the members in the annual status reports. In the sequel, the most important items are summarised, and the activities considered for the next programme period are mentioned.

2.1 R&D issues concerning evolutionary LWRs

HRP fuels sub-programme

The HRP fuels sub-programme was aimed to determine fuel safety and operational margins for use in design and licensing by studying:

- gas release behaviour from fuel under irradiation;
- fuel thermo-mechanical behaviour under irradiation;
- fuel behaviour under accident scenarios;
- fuel behaviour under demanding operation conditions.

In subsection 2.2, selected items are presented according to the following themes:

- gas release under irradiation – fission gas release behaviour, gas inventory increase, tolerable rod overpressure;
- fuel thermal and mechanical performance - conductivity degradation, densification, swelling, fuel creep, pellet-clad-mechanical-interaction (PCMI);
- Fuel behaviour under accident scenarios - loss of coolant accident (LOCA);
- Demanding operation conditions - power transients, PCMI, cladding transient creep, cladding corrosion and hydriding.

The investigations concerned fuels in use in light water reactors (PWR, BWR, VVER) - i.e., standard UO₂, MOX, Gd and Cr bearing UO₂ fuel pellets - and M5, ZIRLO, E110 and M-MDA fuel cladding as well as Zircaloy-4 and Zircaloy-2.



HRP materials sub-programme

The HRP materials sub-programme was aimed to contribute to the knowledge of plant ageing and degradation for lifetime extension by:

- extending the materials database on crack initiation and growth behaviour;
- contributing to the understanding of irradiation assisted stress corrosion cracking (IASCC) behaviour;
- studying irradiation induced changes in component mechanical behaviour;
- determining the effectiveness of ageing and degradation countermeasures.

In subsection 2.3, selected items are presented according to the following issues:

- IASCC of core component structural materials;
- irradiation enhanced creep and stress relaxation;
- reactor pressure vessel (RPV) embrittlement.

2.2 Selected items from the HRP fuels sub-programme

In the framework of the HRP fuels sub-programme, several experimental activities were carried out with the objective of generating new and improved data on fuel properties and fuel behaviour in the entire burn-up range, under both demanding operation conditions and accident scenarios, and utilising fuel materials representative of the current and near-term expected industry standard. In the sequel, the different items to define the fuel safety and operational margins are presented, mainly focusing the attention on the open issues (currently investigated at Halden and considered for the next HRP Programme period), in the prospect of the definition of R&D programmes of possible interest for Italy (see Section 4), as follows:

- studies related to gas release under irradiation;
- thermo-mechanical studies;
- studies on the fuel behaviour under accident scenarios;
- studies on the fuel behaviour under demanding operation conditions.
- studies on innovative fuels and claddings.

Studies related to gas release under irradiation

Fission gas release (FGR) and rod pressure increase contribute to limitations of fuel utilisation in LWRs imposed by safety criteria. FGR is linked to and influences fuel temperatures and therefore has a feedback on a number of phenomena. Data starting at zero burn-up are required for new types of fuels (e.g., fuels with additives and modified morphology) and also for Gd-fuel where high concentrations of Gd (>8%) are desirable for application in extended cycle core loading strategies.



At the same time, more FGR data for high burn-up fuels are needed for fuel behaviour code qualification and to improve their capability to predict steady state operation and transient release. In addition to general release from the matrix, the contribution of release from fuel with high burn-up structure is of special interest. The implications of end-of-life gas inventory on cladding strain and integrity are also issues that needs to be investigated in the future.

A number of participating countries are burning MOX fuel in their reactors as part of their fuel cycle strategy. MOX fuel has to obey the same safety standards as UO₂ fuels and has to be compatible with the overall operational requirements. FGR is a particular issue for MOX fuel due to the higher power at end-of-life compared to UO₂ fuel. The resulting rod pressure concern is amplified by the production and release of helium. In addition to fission gas release, helium release can contribute to as much as 30% of the pressure increase and is therefore an important consideration in safety analyses.

These issues have been, and will continue to be, studied in a number of experiments carried out in the Halden reactor within the HRP Programmes. Many of the tests related to fission gas release will be designed and instrumented in a manner that will provide concurrent data on fission gas release as well as thermo-mechanical properties, and the Project has the capabilities for conducting tests designed both for transient release studies as well as thermal release. Participating organisations contribute to these tests with delivery of fresh, production line and laboratory fuels as well as fuels with high burn-up retrieved from commercial nuclear power stations. The designs of the irradiation rigs are based on successful long-term fuel irradiation experiments with a variety of instrumentation, such as fuel thermocouples, fuel stack or cladding elongation detectors and rod pressure transducers (see subsection 3.2). The instruments provide essential data for the phenomena to be addressed. The ability to re-fabricate and instrument fuel from commercial reactors has been an essential part of the Project's activities for years, and the tests proposed for the next 3-year programme will rely on the continued utilisation of such fuels.

The experiments related to gas release under irradiation considered for the next programme period (2012-2014) are the following: integral fuel performance studies; a MOX helium release test; an ultra-high burn-up irradiation experiment; cladding lift-off experiments; and several experiments dedicated to FGR release from standard, large grain, gadolinia and chromia fuels as well as BeO bearing fuels.

Thermo-mechanical studies

The development and utilisation of new fuels, whether derived from standard fuels or of completely different pedigree, requires a thorough knowledge of in-core properties and performance. Well qualified data obtained from carefully controlled experiments are needed for modelling and



safety assessment purposes. Excluding gas release behaviour (covered in the previous paragraph), the aspects that need to be known about are:

- fuel thermal conductivity;
- pellet cladding mechanical interaction (PCMI);
- fuel swelling / rod growth;
- fuel creep.

Fuel with gadolinia as a burnable poison is being used or considered in all types of LWRs and has thus featured in many experiments performed at Halden., exhibiting a quite different densification and swelling behaviour at beginning of life compared to that of UO_2 fuel.

The interactions between the different phenomena, which develop in a fuel rod during irradiation, are complex. In order to obtain a better understanding of the overall fuel performance, the programme proposed for the next period (2012-2014) contains separate effects tests, experiments dedicated to certain fuel types, and integral performance tests on re-fabricated segments. Many of the experiments are also linked to the FGR issues previously described, and all make extensive use of in-core instrumentation such as fuel thermocouples, rod pressure transducers and fuel stack elongation sensors. These instruments typically give reliable data throughout irradiation histories of 5 years or more.

In particular, the experiments related to fuel thermal and mechanical performance considered for the next programme period are the following: separate effects test for studying the fuel thermal conductivity degradation and recovery mechanisms (including innovative fuel types as available); separate effects test for investigating the fission induced creep both in UO_2 and MOX fuels; experiments dedicated to Gd-fuel behaviour, especially for what concerns its densification and swelling at beginning of life, which differs from UO_2 fuel behaviour; an experiment dedicated to VVER fuel behaviour, in order to reach the target burn-up of about 60 MWd/kg with emphasis on thermal performance (excluding FGR); an experiment to investigate the thermal behaviour of modified fuels (of special interest is the thermal performance of beryllium oxide in a UO_2 matrix, that should lead to an higher thermal conductivity and thus lower fuel temperatures); integral fuel performance studies Gd-fuel with a burn-up of about 50 MWd/kg to yield data on fuel temperatures and PCMI, and FGR as well; cladding lift-off experiments, designed to produce data on fuel temperature, fuel swelling and axial gas communication within high burn-up UO_2 and MOX fuels.

Studies on the fuel behaviour under accident scenarios

The introduction of new cladding materials and, in particular, the tendency to higher burn-up have generated a need to re-examine the safety criteria for loss-of-coolant accidents (LOCA) and to verify their continued validity. As part of international efforts to this end, the Halden Project has

implemented a LOCA test series to study the integral in-reactor fuel behaviour under expected and bounding conditions.

The Halden reactor is suited for integral in-pile testing of fuel behaviour under LOCA conditions using single fuel rods. The decay heat is simulated by a low level of nuclear heating, which produces a temperature distribution in the fuel rod similar to the real case (see Fig. 4). Thus a more correct differential fuel-cladding thermal expansion is obtained compared to out-of-reactor tests, where the cladding is heated from outside and more than the fuel.

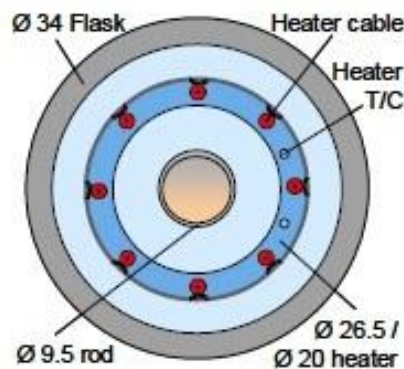

Fig. 4. Schematic cross section of fuel pin, heater and pressure tube used in HRP LOCA studies.

The objectives of the HRP LOCA test series and the test execution conditions were defined in close cooperation with the HPG and individual member organisations, as follows: (i) measurement of the extent of fuel (fragment) relocation into the ballooned region and evaluation of its possible effect on cladding temperature and oxidation; and (ii) investigation of the extent (if any) of “secondary transient hydriding” on the inner side of the cladding above and below the burst region.

At the time of this writing, seven tests with irradiated fuel segments (burn-up 40÷92 MWd/kg) from commercial NPPs have been carried out. The fourth test of the series caused particular attention since the fuel used in the experiment (92 MWd/kgU) experienced substantial fragmentation and dispersal at temperatures far lower than entailed by the current 1200°C / 17% ECR (equivalent cladding reacted) limit. This feature of strong fragmentation and dispersal potentially present in high burn-up fuel was corroborated by another test with “sibling fuel”.

Different degrees of contamination of the loop system employed in the series were observed from test to test. A procedure has been implemented to quantify the amount of iodine released after ballooning and burst since the source term is important for evaluating the consequences of a LOCA.



A continuation of the HRP LOCA test series in the next HRP Programme will aim to provide answers to the original objectives as well as new questions arisen from the tests carried out so far:

- when do fuel relocation and fuel dispersal occur and when can they be excluded?
- effects of burn-up, rod pressure, and corrosion (hydrogen) on integral fuel behaviour during LOCA;
- quantification of the source term (iodine release).

Studies on the fuel behaviour under demanding operation conditions

More flexible or commercial operating modes, such as load following, can result in high and variable stresses being imposed on the fuel cladding with resulting high strains accumulating in the cladding. After the fuel cladding has crept down onto the fuel pellet, which is concurrently swelling, and the initial fuel-clad gap is closed, a stress reversal occurs as fuel swelling starts to drive general clad creep-out. Subsequent fuel swelling, fission gas release and power variations affect the applied stress on the cladding in terms of both magnitude and direction. The in-pile creep behaviour of LWR fuel cladding under variable loading conditions is thus important and needs to be addressed in fuel performance codes. General discussion indicates that there are specific areas where modellers continue to require creep data on well characterised material tested under carefully defined in-pile testing conditions, such as primary creep following repeated stress increments and reversals and for material with a high accumulated fast neutron fluence.

With the trend toward increased fuel cycle length and reactor core ratings, fuel can be challenged by the resulting high discharge burn-up and more aggressive thermal-hydraulic conditions (e.g., coolant temperature and void fraction) and water chemistry conditions. Longer fuel cycles together with power up-rates require higher boron concentrations for reactivity control, which, in turn, leads to the increased need of lithium to maintain the optimal water chemistry conditions. Such operation requires beginning of cycle LiOH concentrations above the current industry limit of 3.5 ppm. PWR primary water chemistry is also being optimised to minimise corrosion product release from the surfaces of steam generators and thus out-of-core radiation fields and crud formation on fuel cladding surfaces. Elevated and constant coolant pH is one potential optimisation method. Operation with constant pH 7.3 or 7.4 (maximum lithium concentration 5-6 ppm) has been demonstrated in a commercial PWR; however before more demanding operation conditions can be implemented in PWRs, it is necessary to confirm that they do not have adverse effects on fuel cladding corrosion and hydriding. One concern is to determine whether a so-called cliff edge exists, beyond which operation will be unacceptable.



Corrosion performance of fuel cladding materials may be limiting under these more demanding conditions, especially in PWRs where an absolute limit of 100 μm oxide is applied, and it has been found that Zircaloy-4 does not always offer sufficient margin. For high duty and extended burn-up applications, several new alloys have been developed and these require comprehensive testing before they can be used in commercial reactors. Both utilities and licensing organisations require the vendor to provide evidence of the corrosion resistance of the materials. The fuel vendor performs the majority of the development work for a new cladding material, varying the chemical composition of the alloy and the manufacturing route, resulting in selection of a small number of candidate materials. It is at this point that in-core testing is required, since in-core corrosion rates are enhanced relative to those measured out-of-reactor.

For burn-ups exceeding 50 MWd/kg, the fuel rim structure is formed and fuel-clad bonding is established. Load follow operation can have strong effects on PCMI and fission gas release. Released fission products can have an effect on fatigue life of the cladding during operations involving a large number of power changes. Further, axial ratcheting as observed in some experiments involving high burn-up fuel may lead to an accumulation of strain increments with a possible impact on cladding integrity. Excessive fuel-clad bonding may also lower the PCMI failure threshold. Regarding PCMI, a mismatch between release and onset of interaction has been observed for shutdown/start-up sequences.

Fuel must continue to satisfy reliability and performance requirements while being exposed to these more demanding operation conditions, and vendors, utilities and regulators all require experimental data to show that safety criteria are met. Such data can be used directly or indirectly (in models and codes), to determine the operating margins during reactor operation and to understand the mechanisms responsible for challenging and weakening the fuel and cladding during irradiation.

All experiments involving the study of cladding behaviour make use of test loops that allow experiments to be performed under representative thermal-hydraulic and water chemistry conditions (i.e., coolant water pressure, temperature and make-up). Since the fuel is also operated under representative linear powers, other parameters such as cladding mid-wall and surface temperatures are also representative. Fast flux levels are maximised where required by surrounding the test fuel with booster fuel rods. All tests are instrumented for measurement of neutron flux and coolant temperature, pressure and flow rate. Test rods are fitted with instrumentation appropriate to the objectives of the experiment.



The experiments related to fuel behaviour under demanding operation conditions considered for the next programme period are the following: a continuation of the experiment commenced in the 2009-2011 Programme, which contains four test claddings (M5, M-MDA, E110 and ZIRLO), to investigate their steady-state and transient creep behaviour under representative PWR conditions; a continuation of the experiment commenced in the 2009-2011 Programme, which contains six test rods with different claddings (M5, M-MDA-SR and ZIRLO) under irradiation conditions (coolant mass evaporation rate and lithium concentration) more severe than those currently allowed in commercial PWRs, to investigate their corrosion and hydriding behaviour by measurements of oxide thickness using an eddy current proximity probe during reactor outages, with post-irradiation determinations of oxide thickness and morphology and hydrogen pick-up; integral fuel performance studies (conducted in such a manner that FGR and PCMI can be also studied) on test fuel rods manufactured from high burn-up rods of commercial reactors, in order to characterise the power cycling / load follow behaviour of the burn-up fuel.

Studies on innovative fuels and claddings

Innovative materials are being looked into as an option for fuels and cladding, to be employed in evolutionary LWRs as well as in Generation IV reactor types.

For fuels, it is desirable to be able to operate at a lower temperature for a given power output in order to reduce fission gas release and other deleterious effects of high temperature operation. Higher fuel thermal conductivity is a prerequisite for this, and candidate materials include uranium nitride, fuel containing beryllium oxide (possibly in a whisker form), and fuel rods with a liquid metal in the fuel-clad gap. In addition, improved fuel performance may be achieved through careful control of fuel microstructure by producing pellets with a microstructure that varies radially through the pellet such as grain size, Gd-content or enrichment.

For cladding materials, it is desirable to avoid the deleterious effects induced by high residence time in a corrosive and radiation environment such as accelerated creep and growth or hydride embrittlement. Sustained dimensional stability is a prerequisite for this, and SiC could be a suitable cladding material in this respect for ultra high utilisation of uranium fuel. An obvious added advantage of this material is that it is also relatively chemically inert.

Several efforts will be carried out in this area in the next HRP research programme (see also subsection 4.1), among which the following ones: (i) integral fuel performance studies of candidate materials, and (ii) characterisation of the in-pile behaviour of SiC cladding. In particular, the integral fuel performance studies will use concurrent measurement of fuel temperature and rod pressure during steady-state conditions to generate data on thermal performance as well as fuel



densification, swelling and possible fission gas release. Characterisation of the in-pile behaviour of SiC cladding will take place under PWR water chemistry conditions, with unfuelled but sealed segments of the cladding. Non-destructive interim inspections and a final destructive post irradiation examination are envisaged to map the behaviour of the material.

2.3 Selected items from the HRP materials sub-programme

In the framework of the HRP materials sub-programme, several experimental activities were carried out with the objective of investigating the plant ageing and degradation effects on reactor vessel internals as well as the RPV integrity. In the sequel, the main items of such investigations are presented, mainly focusing the attention on the open issues (currently investigated at Halden and considered for the next HRP Programme period), in the prospect of the definition of R&D programmes of possible interest for Italy (see Section 4), as follows:

- irradiation assisted stress corrosion cracking of core component structural materials;
- irradiation enhanced creep and stress relaxation;
- reactor pressure vessel embrittlement.

The experimental programme on IASCC was aimed at generating data that provide: a fundamental mechanistic understanding of the phenomenon; predicting behaviour (in particular, the cracking response of irradiated materials); assessing the benefits of countermeasures; and determining the limits of operation for existing materials. An understanding of the processes is considered the key to effective ageing management (i.e., mitigation and/or repair). The majority of the IASCC investigations were performed in loops simulating LWR operating and water chemistry conditions.

Irradiation enhanced creep and stress relaxation are potential degradation mechanisms that may affect core-internals long-term performance. In-pile studies were (and are currently) conducted in inert environments to assess the effects of irradiation and applied load on creep / stress relaxation in materials commonly employed in LWRs.

As to the RPV integrity programme, the Halden Project is now participating, in collaboration with VUJE, in a study aimed at evaluating the use of the small punch test as an alternative method for determining the basic mechanical properties of RPV materials.

Irradiation assisted stress corrosion cracking of core component structural materials

Irradiation assisted stress corrosion cracking (IASCC) occurs under the combined effects of irradiation, stress and a corrosive environment. IASCC is a degradation mechanism that is of



concern for core components as reactors age, and components from both BWRs and PWRs have experienced inter-granular cracking attributed to IASCC.

The austenitic stainless steels and nickel based alloys that are used as structural materials for LWR internals are exposed to radiation environments over extended periods of time. The resultant increases in yield strength, radiation induced segregation, changes in the material microstructure, loss of ductility and fracture resistance are all important factors when addressing plant ageing and licence renewal issues. A better understanding of their manifestation can enable better planning of aging management strategies for power plants.

The experiments on the IASCC of core component structural materials considered for the next programme period (2012-2014) are the following: experiments to generate, with reference to both BWR and PWR environments, long-term crack growth rate (CGR) data as a function of temperature, corrosion potential, fast neutron flux and stress intensity levels from Compact Tension (CT) specimens prepared from irradiated core component materials; crack initiation / integrated time-to-failure tests on materials with different doses, in order to provide information on time-to-failure as a function of applied load as well as to study the effect of dose. In both the CGR and the crack initiation / time-to-failure experiments, the effects of mitigation measures, such as low ECP (Electrochemical Corrosion Potential) and post irradiation annealing treatments, will be also addressed. Post irradiation characterisation of the materials used in the above mentioned tests will constitute an important supplement to the in-pile data. In addition, the history of the core component materials that are being used in the various investigations is also of importance, and efforts are made to obtain as much information as possible on the conditions (flux, fluence and temperature) to which the materials were exposed in the commercial nuclear power plants from which they were retrieved.

Irradiation enhanced creep and stress relaxation

Irradiation induced creep and stress relaxation is a potential degradation mechanism that may influence the service life of, for example, the bolting used in reactor vessel internals, where design requires that a minimum load be maintained throughout service. Since the initial stresses in structural components will vary during reactor operation, information on the effects of irradiation on the creep and stress relaxation of stainless steels and Ni-alloys used in structural components is an important design and analysis requirement, for example in determining the amount of pre-load required for components and for predicting when bolt tightening may be necessary.

Since most irradiation creep and irradiation stress relaxation 316 SS and 304 SS tests have been performed in fast neutron spectrum reactors, the purpose of the next HRP Programme is to measure



the irradiation creep and irradiation stress relaxation of common reactor structural materials (such as 316 SS, 304 SS and Alloy 718) in a thermal neutron reactor spectrum prototypic of PWRs and BWRs (see Table I).

Table I - Instrumented Specimen Matrix for Stress Relaxation / Creep Investigation.

Level	Unit.No.	Material	Sample Type	Initial Stress (MPa)	Target Temp (C)
1 (bottom)	1	CW 316	Rod	275	330
	2	CW 316	Rod	205	330
	3	CW 316 LN	Tube	345	330
2	4	Alloy 718	Rod	345	330
	5	Alloy 718	Rod	345	330
	6	CW 316	"Qualification" sample	28.6	330
3	7	SA 304L	Tube	110	290
	8	SA 304L	Tube	92	290
	9	CW 316N lot	Tube	345	370
4 (top)	10	CW 316	rod	345	330
	11	CW 316	Rod-creep	345	330
	12	CW 316	Rod-creep	345	330

Reactor pressure vessel embrittlement

The effect of neutron embrittlement on pressure vessel materials remains a safety issue that traditionally is assessed on the basis of testing Charpy-type specimens irradiated as part of surveillance programmes. The limited amounts of available material for such tests are being resolved through reconstitution techniques and miniaturisation of test specimens. In order to establish proper correlations between the data from sub-size specimens with those of standard size, experimental verification is still required.

During the 2009- 2011 HRP Programme, in an investigation that was performed in collaboration with VÚJE, the use of the small punch test (SPT) method, which reduces the amount of material required to determine the basic mechanical properties of a material, was evaluated. The SPT method was used to obtain data on the basic mechanical properties (yield stress, ultimate tensile strength, ductile-to-brittle transition temperature and fracture toughness) of three materials:

- the base and weld metal of the RPV steel 15Ch2MFA, a reference material produced by Izhora plant (Russia), and also used in an international round robin co-ordinated by the IAEA on the evaluation of the irradiation embrittlement of the welds of WWER-440/230-type RPVs;



- The reference steel JRQ (ASTM A533 grade B class 1), used as a radiation/mechanical property correlation monitor in a number of studies on irradiation embrittlement of RPV steels.

On the basis of the actual results from the 2009-2011 study, as well as results obtained from surveillance specimen programmes implemented in Slovak power reactors, a new project conducted in collaboration with VUJE (Slovakia), within the next HRP Programme, will be aimed at preparing new sets of SPT and miniature tensile specimens prepared from RPV materials (RPV wall materials and RPV internals in the reactor). The proposed materials as well as the SPT specimens will be applied in the Advanced Surveillance Specimen Programs in Slovakia. The results from the HRP-VUJE proposed project will thus provide the possibility for assessment of the dose rate effect on real RPV materials.



3 STATUS OF RESEARCH IN THE INSTRUMENTATION & CONTROL AREA (ITEM C1)

3.1 R&D issues concerning evolutionary LWRs

As far as the R&D issues on plant control and monitoring are concerned, they pertain to verification and upgrades of systems for signal validation, performance monitoring, plant diagnostics and support, and alarm handling. The latter belongs to the framework of the Human Factor (HF) programme, which is out of the scope of the present report. In the next subsection, the major progresses achieved during the last HRP Programme (2009-11) in the Instrumentation & Control (I&C) area are presented. They mainly concerned: (i) the development of in-core instrumentation for measuring all key parameters for fuel studies, such as fission gas release, fuel temperature, fuel swelling, cladding creep; (ii) the definition of physics-based models for condition monitoring; (iii) the definition of methods for plant-wide sensor validation; (iv) the refinement of ageing and condition-based models for remaining useful life estimation; and (v) cable ageing assessment. It is worth mentioning that the work on cable ageing has resulted in a technique that is being used at an industrial level to assess whether cable insulation is damaged, and in those cases to determine the extent and location of the damage.

3.2 Selected results

In-core instrumentation for fuel studies

Within the framework of the Halden Project, different types of instruments have been developed for fuel studies, such as fission gas release, fuel temperature, fuel swelling, cladding creep, etc. Many of these were already developed a long time ago, but have been continuously improved and refined since then. It is the objective of the following items to describe a selection of these instruments (i.e., the linear variable displacement transducer, the pressure sensor, the expansion thermometer as well as the new prototypes of diameter gauge and oxide thickness probe).

An overview of in-pile material characterization as well as of most in-core corrosion monitoring techniques, including instruments for measuring crack growth, crack initiation, irradiation creep, in-core water conductivity, fuel cladding thickness and electrochemical impedance spectroscopy has been presented elsewhere¹, and is out of the scope of the present subsection. Here, it is worth mentioning that for material corrosion studies, new electrochemical sensors have been developed,

¹ P. Bennett and T. Karlsen, In-core corrosion monitoring in the Halden test reactor, in Proc. Eur. Corrosion Congr., Freiburg in Breisgau, Germany, September 9–13, 2007, p. 210.

such as platina and iron/iron oxide reference electrodes. These electrodes are based upon brazed ceramic metal transitions, leading to a significant reduction in size and making them particularly suited for in-pile electrochemical impedance spectroscopy. These new in-core miniaturized reference electrodes for material corrosion studies will soon be tested in-core.

- *Linear Variable Displacement Transducer*

The heart of many of in-core instruments is the linear variable displacement transducer (LVDT). The LVDT is a versatile instrument used to transform a mechanical movement into an electrical signal. The primary coil is activated by a 400 Hz constant-current generator and the position of the magnetic core in relation to the coils affects the balance of the signal from the secondary coils. Thus any mechanical movement changes the position of the magnetic core, and the corresponding signal can be measured.

The LVDTs are designed to operate under PWR conditions (350°C and 150 bar).

Fig. 5 shows the principle design of our LVDT. The LVDTs are made in many different sizes at customers request, but the most used size is the "type 5" LVDT. This LVDT has a linear range of ± 2.5 mm, hence, the "type 5" designation referring to the linear range of the LVDT. The accuracy of the LVDT is ± 1 μm . The size of this LVDT is $\Phi = 11.5$ mm and a length of 55 mm. The signal cables used are 2-wire mineral insulated (Al_2O_3) cables with Inconel 600 sheath. The outer diameter of the cables is 1.0 mm.

Since the Halden Reactor Project started making in-core measurements, more than 2200 Linear Voltage Differential Transformers of different types have been installed in test rigs in the HBWR. A failure rate of less than 10% after five year operation is expected for LVDTs. After an initial (within one day) drift of 3%, the LVDT sensitivity remains stable over many years. Some LVDTs have survived about 10 years in the Halden reactor.

LVDTs for operation at higher temperature (up to 550°C) have recently been developed. In these LVDTs, the wires are made of anodized aluminium.

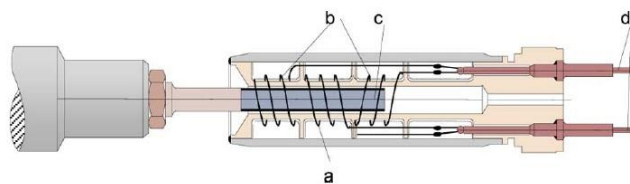

Fig. 5. Principle of the LVDT: (a) primary coil; (b) secondary coil; (c) ferritic core; and (d) signal cables.

- *Fission Gas Pressure Sensor*

The pressure transducer provides data on fission gas release by means of measurements of the fuel rod internal pressure. The pressure transducer consists of a miniaturized bellows mounted in the fuel rod end plug. A magnetic core is fixed to the free moving end of the bellows; the other end of the bellows assembly is fixed to the end plug. The bellows is pressurized to typically 2 bar less than the initial rod pressure and seal welded. Bellows/core movements are sensed by an LVDT. A schematic drawing of the pressure sensor is shown in Fig. 6.

The pressure transducers are available in different pressure ranges. The most common ranges have a Δp (internal vs. external pressure of the bellows) of 15 bar (type I), 30 bar (type II) or 70 bar (type III). Since the displacement in each of these is measured by the same type of LVDT (type 5), the sensitivity of the 70 bar pressure sensor is lower than that of a 30 bar pressure sensor. Under realistic conditions, the uncertainty of the pressure for the 30 bar sensor is about 0.2 bar while for the 70 bar sensor it is about 0.5 bar. In order to keep the same precision as a type II transducer, while still being able to reach 70 bar, a new type of transducer has been designed: two different bellows, having different levels of stiffness, are connected in series. In this way, the pressure range up to 30 bar is measured with the same precision as a type II pressure transducer.

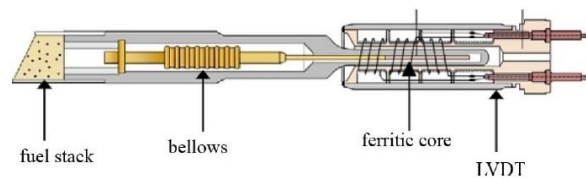

Fig. 6. Principle of the pressure transducer.

- *Fuel Temperature Measurements*

There are two types of fuel temperature measurements available; the fuel thermocouple (FT) and the expansion thermometer (ET). The fuel thermocouple is normally a tungsten-rhenium type of thermocouple. Mainly due to thermal neutron induced transmutation, these thermocouples have a drift which has been carefully studied and characterized such that it is possible to compensate for it. Fast neutron induced structural changes could also lead to a slight thermocouple decalibration, though the changes are expected to saturate already on a short time scale. The expansion thermometer (Fig. 7) on the other hand does not experience such a drift. This thermometer is

based upon a measurement of the thermal expansion of a tungsten rod which passes through a center hole drilled through the entire fuel stack. The thermal expansion of the tungsten rod is measured by means of an LVDT. The ET is often used for long duration tests and for very high temperature measurements. Presently, thermocouples are under investigation (in collaboration with Idaho National Laboratory) in which only materials with low neutron cross sections (such as alloys of molybdenum and niobium) are used. These thermocouples are expected to have negligible neutron induced drift.

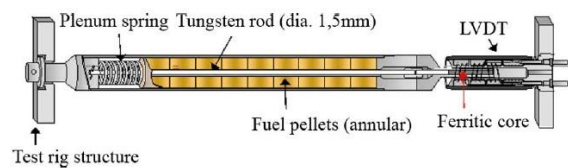

Fig. 7. Principle of the expansion thermometer.

- *New Prototype of Fuel Diameter Gauge*

The diameter gauge (DG) is based upon the LVDT principle. The DG differs from the LVDT however in several ways: the two primary coils and the two secondary coils are wound on a ferritic bobbin as opposed to the Inconel bobbin of the LVDT. The DG uses a ferritic armature instead of the ferritic core used in the LVDT. The change in air gaps in the two secondary loops, indicated by the blue ovals in Fig. 8, changes the balance between the signals generated in the two secondary loops, leading to a change in the output signal (difference of the two secondary coil signals) from the DG.

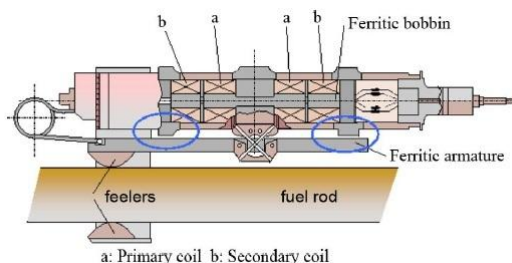

Fig. 8. Schematic drawing of the diameter gauge.

As can be seen from Fig. 8, the design of the DG is rather complicated and sections of nonmagnetic material have to be welded to sections of magnetic material (grey parts in Fig. 8). Therefore, a new design has been made in which the outer wall of the DG consists of a single uninterrupted tube of Inconel 600. The resulting magnetic field pattern is shown in Fig. 9.

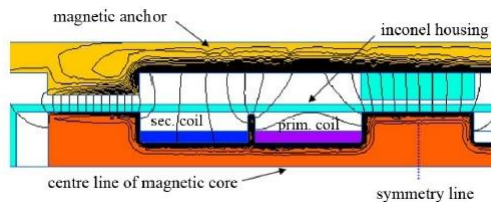

Fig. 9. Magnetic field pattern in the simplified DG.

Another novelty in this design is that the coil separators are made of the same material as the inner magnetic body. In this way, the fabrication is simplified further. In order to prevent flux linkage between the (magnetic) coil separators and the ferritic armature ("anchor"), these separators are reduced in height at the side facing the ferritic armature. This is shown in Fig. 10.

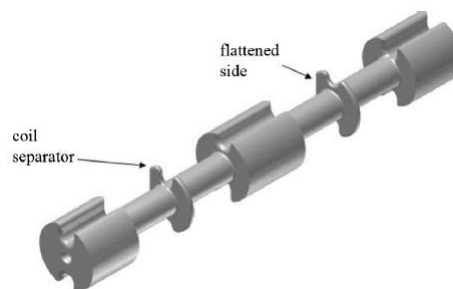

Fig. 10. Inner body of the simplified DG.

Using an outer body of Inconel increases the distance between the magnetic inner parts and the anchor, leading to a loss of sensitivity. To compensate for this, the distance between anchor and outer tube has been reduced slightly. In addition, the inner body is made out of silicon iron "B-FM" from Carpenter which has a significantly higher magnetic permeability than AISI 403, being used in the standard diameter gauge. Other benefits of this material are reduced eddy current losses, leading to a reduced temperature sensitivity.

Tests show that the new diameter gauge (Fig. 11) has a rather linear response over the range -0.9 mm to $+0.9$ mm. In practice, however, one would need only a total range of 0.2 mm. Over this limited range, the linearity is of course very good (and better than the one of the standard DG).



Fig. 11. Picture of the new DG prototype.

- *Prototype Probe for Oxide Thickness Measurements on Fuel Cladding*

Corrosion of fuel cladding under various chemical and power load conditions remains an active field of research. Such corrosion studies are nearly always performed by post irradiation examination. Online studies could however provide significantly more information, and therefore a probe is presently under development for the online in-pile measurement of oxide thickness. The new probe in question is based upon the eddy current principle. A drawing of the probe is shown in Fig. 12. The idea is to move this probe along the rod by means of a hydraulic system similarly to what is done with the diameter gauge. In this case, a slight pressure (using a spring system) is used to ensure continuous contact with the fuel cladding.

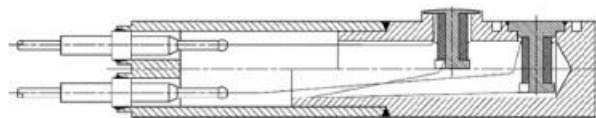

Fig. 12. Drawing of the new oxide thickness probe.

The probe is designed to operate under PWR conditions (150 bar, 350°C) and is made of an all enclosed metal (AISI 316) housing. It was required that the probe could measure oxide layers up to $100\ \mu\text{m}$ thick. As can be seen from Fig. 12, the probe consists of one sensing coil (slightly extruding) and one reference coil (situated completely inside the housing and shielded by it). The two coils are part of a resistance bridge circuit, such that a small difference in coil impedance can be detected. The reason to have the reference coil situated inside the probe (and not on the outside of the reactor) is that temperature variations, inducing resistance changes in the coil and



the signal cables, are automatically compensated for. The top of the sensing coil has been designed such as to be sufficiently strong to withstand the external pressure, while at the same time being thin enough to transmit enough of the RF field (to generate the eddy currents in the fuel cladding). The probe housing itself is used as the common earth connection for both coils (and in turn connected to the cable sheath).

For the coils, 205 turns of AWG 37 Kulgrid (Ceramawire) are used. The DC resistance (R) of each coil is 4.7Ω , while the inductance (L) is $34 \mu\text{H}$. The coil core material is made of nonferritic stainless steel. A nonferritic material was chosen because ferritic materials have the tendency to experience a small change in magnetic permeability under neutron irradiation. One of the main difficulties in designing an in-core eddy current probe is related to the long signal cables required to transmit the signals from a location inside the reactor core to the electronics outside of the reactor. In the case of the Halden reactor, the required cable length is 18 m. In order to reduce losses in the cable as much as possible, special high frequency cable has been selected. This high frequency cable (type 1 C CAc 10Si from Thermocoax) with a diameter of 1 mm has a characteristic impedance of 50Ω (such that wave reflections within the cable are minimized), and has a line capacity of only 100 pF/m. The resistance of the 18 m long cable is 22Ω . The probe has been designed to operate in the frequency range 200 –300 kHz. For these frequencies, the probe impedance (Z) is in the neighbourhood of 50Ω and the operating frequency is sufficiently below the resonant frequency (643 kHz). At a frequency of 300 kHz, the Q-factor of the probe (given by Z/R) is 13.6. A high Q-factor leads to high accuracy and stability. At a frequency of 300 kHz, the skin depth (in AISI 316) is 0.79 mm (at room temperature), which is sufficiently large to allow sufficient field penetration through the 0.4-mm thin steel cap in front of the sensing coil. The electronic detection system used was a Phasec D60 unit (Holger Teknologi).

Testing of the system was performed at room temperature, using the 18 m long signal cables. A nice linear response is obtained over the region $0\div 100 \mu\text{m}$, and the resolution of the probe is as small as one micrometer. In the future, the probe response will be tested at high temperature and high pressure in an autoclave (150 bar, 350°C). If these tests are also successful, an in-pile experiment will be performed in the Halden reactor. Here, one should perform the experiments in such a way that crud formation on the fuel rods is minimized. In the presence of magnetic crud, the eddy current probe will not simply measure the thickness of oxide layer plus the thickness of the crud because the magnetic material will perturb the magnetic field lines and thereby strongly perturb the measurement. For performing in core testing, one therefore could install a stainless

steel brush (fitted to a diameter 0.5 mm smaller than the test rods) to remove most of the crud layer.

Physics-based models for condition monitoring

The ultimate aim of On-Line Monitoring (OLM) is to have global monitoring of the plant performance. It is expected that by modelling the whole plant and comparing actual measurements with expected values from the models, early detection of anomalies and faults will be possible. Through detailed analysis of the observed anomalies, diagnostic methods which may include physics-based monitoring can be applied to the measurements to perform fault identification.

For example, the *data-reconciliation method* compares a physical model of the turbine cycle to actual plant measurements (Fig. 13). How well this model fits to the plant data is then used in fault analysis. The difference between measurement values and their fitted values is called the measurement residual and σ_v is the uncertainty in this residual. Each measurement point is assigned an uncertainty. How well the simulation fits to the measurements is compared to the given uncertainty. Traditionally this comparison is directly used to determine if there is a fault in the measurement. This requires that the uncertainty is a true representation of the random variance of the measured value.

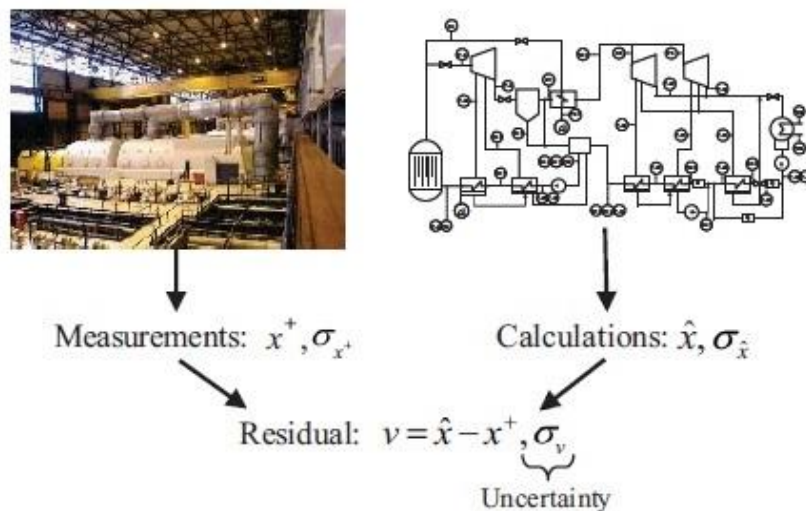

Fig. 13. Condition monitoring of the plant's performance.

An example of this has been conducted with the Loviisa model. The Loviisa 2 NPP consists of two parallel turbine cycles that are connected at several locations. The model includes both turbine cycles, which are calculated simultaneously. The model consists of 205 components, 193



measurements and 92 parameters that varied during the calculation. Calculation time is around 30 min for each data point with one year of data (366 data points) used in the analysis. The VVER-440 reactor consists of two parallel turbine cycles with connections and is modelled together in a single model. This model has been in on-line calculation mode since 2004 and consists of 184 components, 178 measurements and 63 variable parameters (see Fig. 14). After a turbine trip event the Loviisa NPP unit 2 returns to full power. Following the event, a difference appeared between the physical model and actual measurements from a pressure sensor (see Figs. 15 and 16). Operating staff suggested two possible scenarios, either a fault in the instrument or a valve stuck half closed. The two scenarios were modelled and tested to see which would result in the better fit to the available data. Findings determined that the faulty measurement scenario resulted in the better fit. Subsequently, a work order was placed to check this measurement before consideration of a valve check. It was determined that the problem had been solved. This work demonstrated that physical modelling techniques can be used to help make effective maintenance decisions.

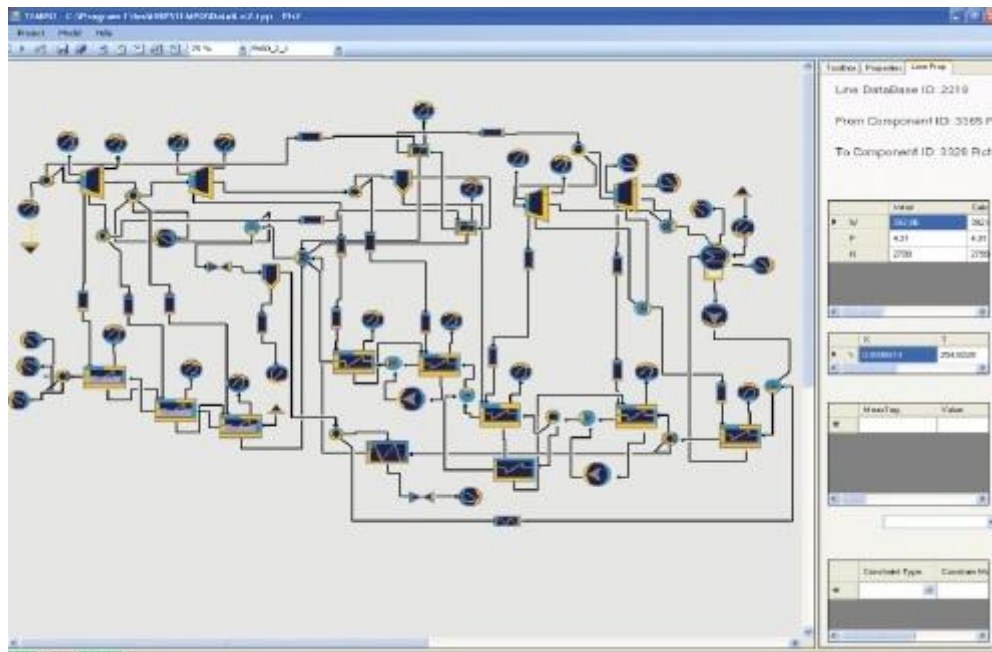

Fig. 14. Screen shot of the NPP schematic.

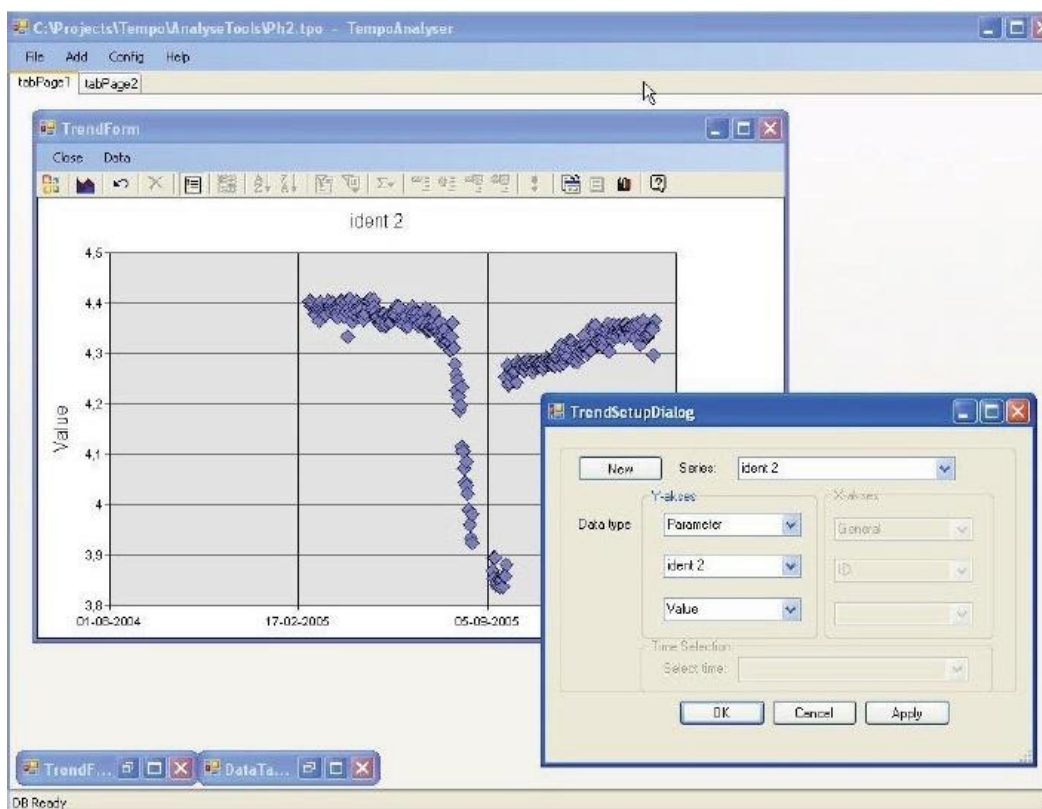

Fig. 15. Tracking of a pressure measurement data.

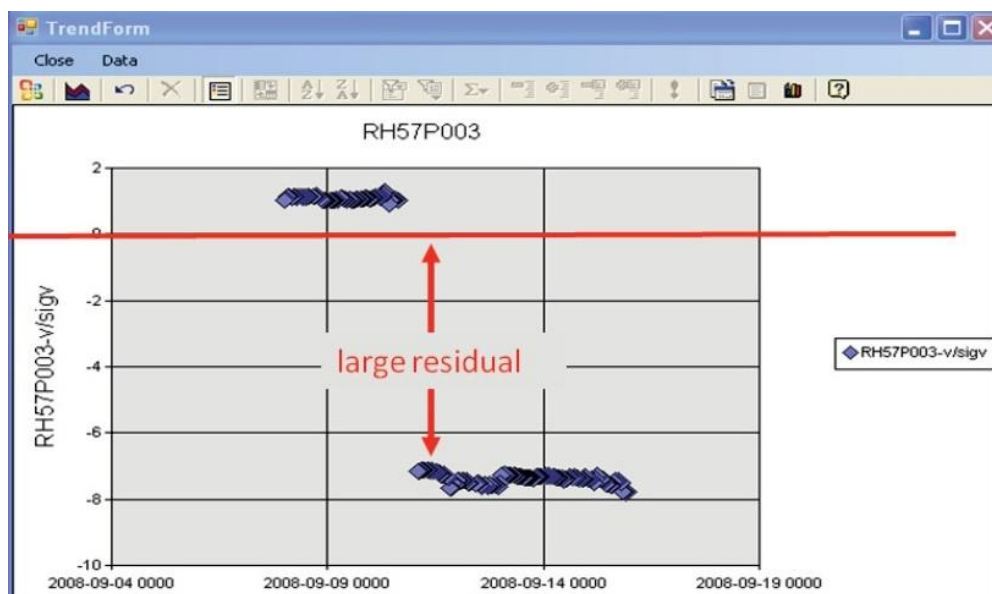

Fig. 16. Correlation of the pressure sensor data with the physical model showing a large residual indicating a strong disagreement.

Methods for plant-wide sensor validation

Sensor Validation is a critical aspect for identifying instrumentation failures and calibration problems, which can affect the safety and economics of nuclear power plant operation. There is a significant need for on-line monitoring for sensor failure and calibration. On-line correction of degraded information is necessary as well. In order to reduce maintenance costs, calibration of the out-of-calibration instruments must occur in a timely manner. Safety may be enhanced by determining the availability of validated measurements.

Figs. 17÷21 give some examples of sensor validation technology.

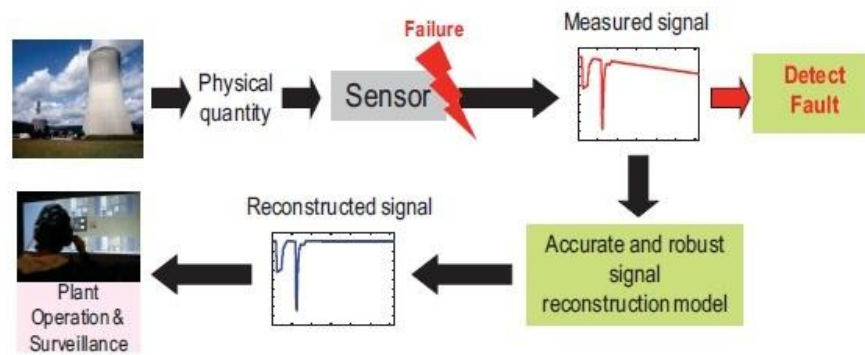

Fig. 17. Sensor validation technology.

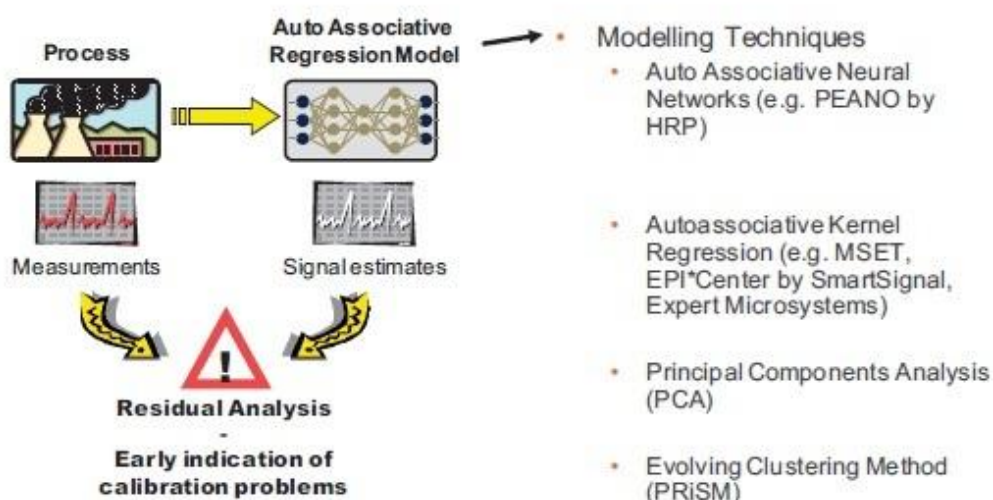

Fig. 18. Sensor validation technology.

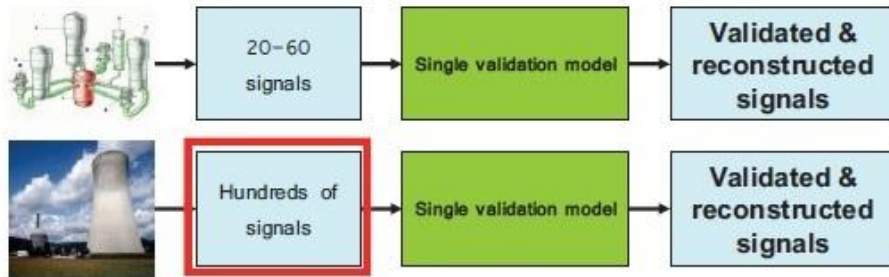

Fig. 19. Large-scale sensor validation.

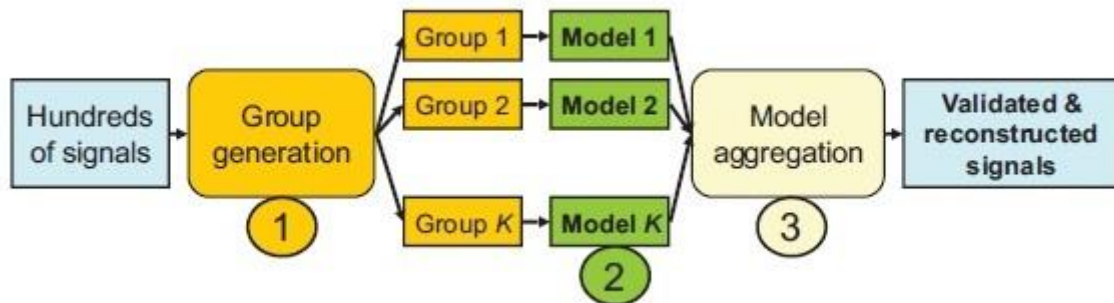

Fig. 20. Multi-group ensemble approach.

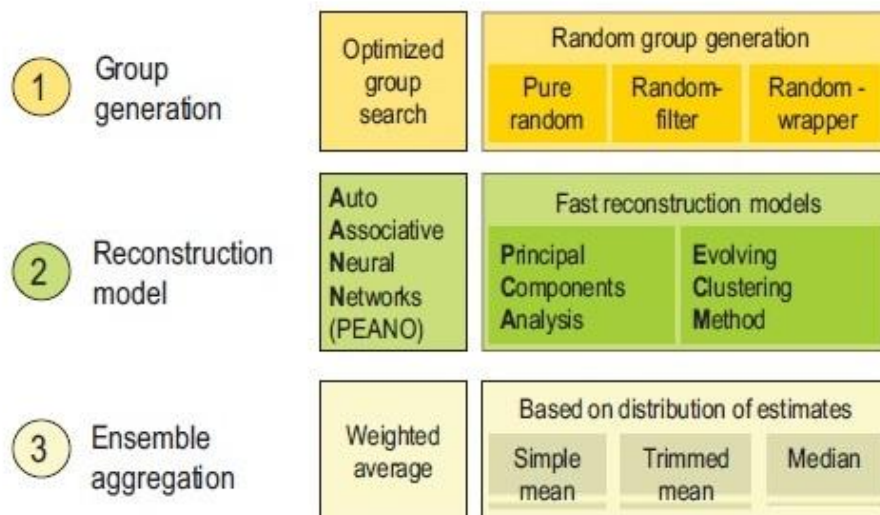

Fig. 21. Multi-group ensemble approach.

Ageing and condition-based models for remaining useful life estimation

When lifetime modelling (Fig. 22) and deterioration modelling are compared, results indicate that only failure times are considered. Additionally, deterioration modelling data has been shown to represent a greater amount of failure time data. The end-of- useful-life occurs when deterioration crosses a threshold. Deterioration models are required for Condition-Based Maintenance (CBM) to be implemented.

If the condition of the system is known, the remaining useful life (RUL) can be calculated (prognostics) using:

- General degradation path models;
- Gamma process models - degradation is a continuous quantity;
- State space models - degradation is discrete (good, OK, bad...);
- First principles models.

Remaining questions to be answered are:

- How does the component deteriorate in average
- What is the deviation from this average path?

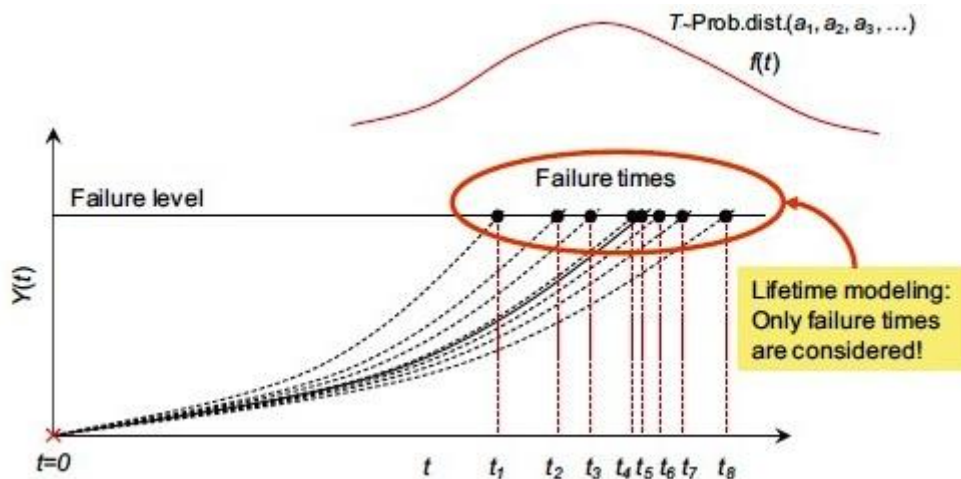

Fig. 22. Defining the statistics for predicting RUL.

Cable ageing assessment

The interest in safety aspects of cable ageing is increasing worldwide because of the impact on several industrial fields, such as power generation, transportation and defence. Although the environmental conditions and degradation mechanisms of installed cables can be different in each application, the negative consequences of cable failures, both from a safety and performance



standpoint, are so important that almost all countries in the industrialized world have some research project in progress in this area. In the nuclear field, where cables are normally qualified before installation for an expected life of 40 years or more, a number of issues exist for which adequately solutions have not been procured.

These issues include:

- The effect of the particular adverse environment conditions (high radiation, humidity and temperature) on cables, especially during and after a Design Basis Event (DBE).
- Extending the plant life after 40 years, including the requirement to assess and qualify the cable conditions for a longer time.
- Existing cable-condition monitoring techniques, which are not considered sufficiently accurate and reliable for all cable materials and types in use at their installed applications. Additionally, the bulk of these are non-destructive techniques, not applicable *in situ*.
- Accelerated ageing techniques for qualification purposes under DBE conditions, which are often not conservative and should be complemented with reliable condition-monitoring methods.

In the sequel, with regard to the above-mentioned issues, limitations and needs, a brief overview is presented focusing on the cable qualification processes as well as on three Condition Monitoring (CM) techniques, whose performance has been recently assessed at Halden.

- *Cable Ageing Overview*

The operational environment in nuclear power plants challenges the installed electrical cables and the integrity of protective insulating jackets (a typical cable structure is shown in Fig. 23). High temperatures (45 to 55°C), gamma radiation, humidity, and steam induce ageing in the cables. Long-term operation of cables in harsh environments can lead to insulation degradation and, consequently, a loss of functionality.

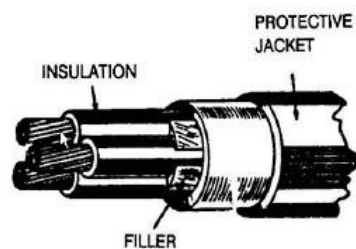

Fig. 23. Structure of a typical power cable in a nuclear power plant.



Many plants that are currently in operation are approaching the end of their Qualified Life (QL). QL can be defined as the time of operation after which the equipment has been demonstrated to perform satisfactorily during and after a subsequent DBE test. A Qualified Condition (QC) can be defined as the level of degradation, given as a condition monitoring (CM) indicator value, due to ageing at which the equipment has been demonstrated to perform satisfactorily during a subsequent DBE test.

The consideration of plant-life extension for another 20 years of operation brings up the question of the assessment of ageing components, including cables. Recent events in operating nuclear power plants suggest that some cables may be in worse condition than had been expected. The worse-than-expected cable condition has motivated the need for a cable ageing program.

As far as the thermal and radiation ageing of cables, the following two basic types are of concern at nuclear power plants: bulk ageing where an entire room or space within a plant has elevated temperature or radiations conditions, and local ageing where a localized heat or radiation source such as a pipe is close to a cable tray or conduit. Identification of bulk area conditions are generally fairly easy in that the temperature or radiation levels in an entire room are known with a reasonable level of precision. Localized ageing is somewhat more of a problem in that identifying all possible localized adverse conditions is time consuming and somewhat difficult. In addition, determining whether the localized condition has significantly affected a cable may be difficult if the cable is located inside a conduit or located in a tray that requires scaffolding or other access means to allow the condition to be assessed. Accordingly, a means of assessing the condition of a cable from its terminations by electrical means is desirable.

Until recently, the changes in the electrical characteristics of low-voltage insulations caused by thermal and radiation damage have been too subtle to be detected electrically from the terminations until the damage is so severe that cracking or powdering has taken place. Even at that point, good insulation resistance readings may occur as long as the insulation remains dry and the circuit is not physically disturbed. Accordingly, ageing characterization methods have concentrated on mechanical and chemical properties. Tests such as the indenter measure modulus (a form of hardness), and many chemical tests are available for laboratory assessment. Depending on the type of insulation and jacket polymers, thermal and radiation ageing causes chemical changes in the material that can be easily measured and compared to trending data from accelerated laboratory ageing. These tests are useful when the surface of the cable is accessible or the insulation can be evaluated at the terminations. They cannot be used for cable contained in a conduit unless the cable is pulled out.

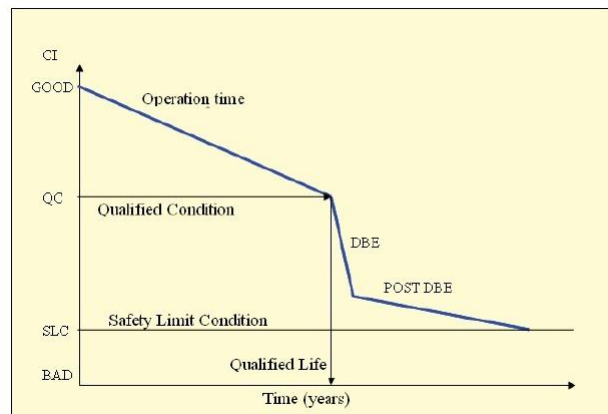

Fig. 24. Qualifying the end-of-life of a cable.

- *Cable Qualification*

Environment-qualified (EQ) safety cables must be operable at the end of their qualified life, during and after a LOCA accident, in order to support the actions required to bring the plant to a safe shutdown condition. To qualify an EQ safety cable, a process of accelerated thermal and irradiation ageing followed by testing is performed on cable samples (Fig. 24).

The qualification process begins by bringing a cable sample to an ageing condition equivalent to the cable's condition after a desired period of time, assuming the thermal and irradiation ageing existing during normal operation. The cable sample is exposed to harsh environmental conditions, equivalent to those existing during a loss of coolant accident (LOCA). The cable is then subjected to a withstand-voltage test to verify that it is capable of performing its function. Other evaluation tests, like insulation resistance, are also performed at this time. The Arrhenius equation for accelerated ageing demonstrates is usually adopted as relationship between time and temperature in thermal ageing.

A number of uncertainties in qualified life may be determined from artificial accelerated ageing such as:

- uncertainty in activation energy values;
- non-Arrhenius behaviour when test temperatures exceed threshold values (insulation dependent);
- effect of simultaneous exposure to several degradation agents (e.g., radiation or temperature);
- non-uniform conditions in the environment parameters (hot spots);
- severity of environmental parameters during normal operation;
- number of samples used in type testing;



- test uncertainty (small volume chambers).

Advantages of the QC approach include:

- there would be no dependence on such uncertainties as activation energy, environment conditions, dose rate effects;
- When the cable is exposed to milder environment conditions, it can justify operation beyond qualified life.

A Condition Monitoring (CM) technique is needed for the QC approach. Current CM techniques include:

- visual inspection (always good);
- oxidation induction time (OIT) (local, laboratory);
- insulation resistance (in-situ, off-line);
- time domain reflectometry (TDR) (in-situ, full-length);
- infrared spectroscopy (local, laboratory);
- ultrasound (in-situ, off-line, local);
- nuclear magnetic resonance (NMR) (local, laboratory);
- elongation at break (EAB) (destructive);
- indenter (local, in-situ, on-line);
- line resonance analysis (LIRA) (in-situ, on-line, full-length).

The efficacy of current CM techniques is strongly suggested by a good correlation between EAB, the indenter and LIRA in global thermal-ageing experiments, hence a quick overview of these three last methods is herein presented.

- *Elongation-At-Break*

Elongation-at-break (EAB) is the strain on a sample sufficient to cause it to break. This usually is expressed as the percent of elongation achieved at the instant the sample breaks. Fig. 25 shows a schematic of the equipment used to test EAB, while Fig. 26 shows EAB of materials as a function of exposure to excess heat.

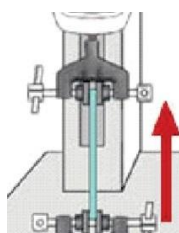

Fig. 25. Schematic of the equipment used to test EAB.

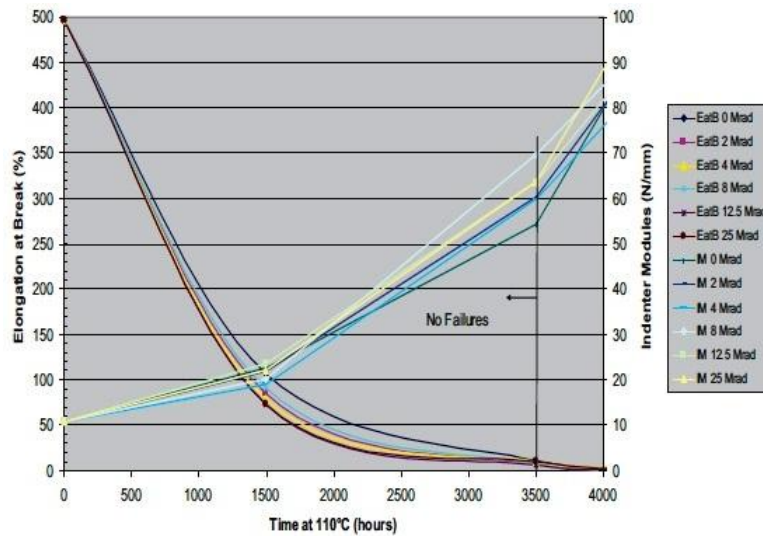

Fig. 26. Cable elongation-at-break characteristics as a function of time held at elevated temperatures.

- *Indenter Modulus*

The surface hardness of both jacketing and core insulation is monitored by micro-indentation. A sharp indenter is pressed against the surface at constant velocity, and the force is recorded as a function of penetration depth. The slope gives the indenter modulus with the unit N/mm.

- *Line Resonance Analysis Method*

The line resonance analysis method (LIRA) has been developed in the framework of a collaboration between HRP, IFE and EPRI².

The advent of LIRA has provided a means to detect thermal and radiation damage to cables because it can detect small changes in electrical properties of insulation materials on the order of 1 pf. This detection capability allows localized and bulk thermal ageing to be identified well before the material has aged to the point of cracking or powdering. Performed tests indicate that LIRA can identify damage below the point where a cable can no longer pass a LOCA test. The results also indicate that trending of the severity of damage is possible if LIRA tests are performed periodically.

LIRA may be used to assess the condition of cable circuits that traverse multiple rooms with different environmental conditions and circuits with intermediate termination points, such as

² P.F. Fantoni, Wire System Aging Assessment and Condition Monitoring: The Line Resonance Analysis Method (LIRA), Halden Reactor Project (HWR-788), 2005.



splices and terminal blocks. LIRA will also be a useful troubleshooting tool if there is a concern that significant installation damage has occurred. The tests proved that LIRA can identify cuts and gouges in the insulation system and identify thermal or radiation damage.

LIRA presents a significant addition to the tools available to evaluate cable condition and ageing. Because the system allows the location of the adverse condition to be identified, the position of the hotspot along the length of a cable circuit can be reviewed to determine if a heat or radiation source is present or if another damage type is present in the cable. Conversely, if a heat source is identified adjacent to a conduit system, LIRA may be used to determine if significant damage has occurred adjacent to the source.





4 R&D PERSPECTIVES OF INTEREST FOR A NATIONAL PROGRAMME (ITEM C2)

In this Section, the basis for the definition of R&D programmes of possible interest for Italy, in terms of development and qualification process for both the Fuels & Materials and Instrumentation & Control areas, is briefly outlined. In Fig. 27, the more general framework of the NPP main components that need certification and qualification is shown for completeness.

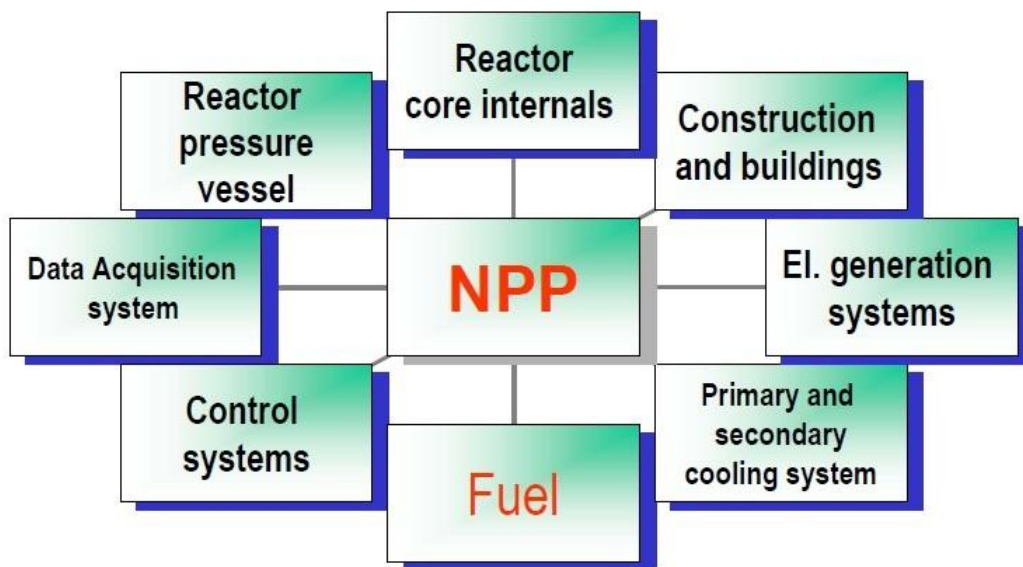

Fig. 27. Sketch of the main NPP components needed for certification and qualification.

Qualification is the process of certifying that a certain product has passed performance and quality assurance tests or qualification requirements in regulations stipulated in nationally or internationally accredited test standards. Such process starts with national authorities, which can accredit the following:

- national or international standards and regulations;
- certification organizations;
- testing organizations.

In the next two subsections, the development and qualification process required in the F&M and I&C areas are presented, focusing mainly on the fuel/cladding and the instrumentation items.

4.1 Fuels & Materials area

Motivation for fuel development and qualification is essentially based on the following items, according to the target represented in Fig. 28.

- Enhancing of operation efficiency of commercial NPPs:
 - increase fuel power and burn-up;
 - prolongation of fuel cycle;
 - load follow power;
 - minimisation of fuel failure.
- Enhancing of safety:
 - review of accepted fuel safety criteria with emphasis on steady state conditions, operational transients, an design basis accidents.
- Introduction of innovative fuels and materials:
 - improving economics and safety of operating NPPs;
 - utilisation in new generation nuclear reactors;
 - non proliferation issues.

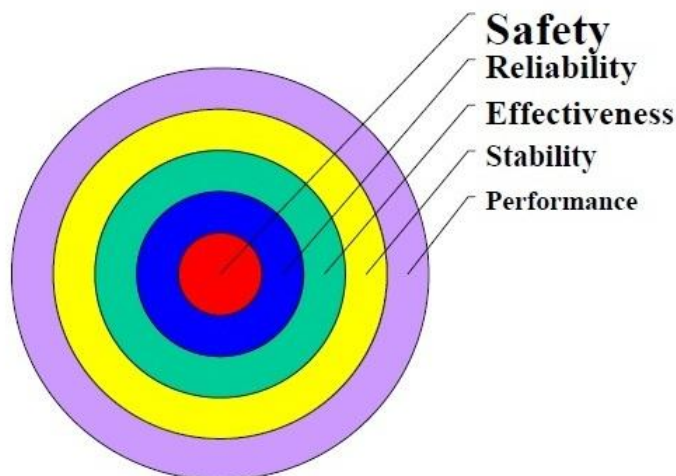

Fig. 28. Target for fuel and material development.

The required process of innovative fuel and materials development and qualification is sketched in Fig. 29, whereas the main issues motivating the necessity of experimental support are depicted in Fig. 30.

Process of innovative fuel and materials development and qualification

Phase I: Research and Development (R&D)

- ✓ Fuel conceptual design;
- ✓ Fuel manufacturing technology development;
- ✓ Out-of-pile testing to determine basic properties;
- ✓ In-pile testing in research reactor to determine irradiation properties;
- ✓ Decision: to continue R&D or move to Phase 2.

Phase II: Fuel performance qualification

- ✓ Detailed design with technical specification;
- ✓ Prototype manufacturing assessment and development;
- ✓ Prototypic fuel element and fuel assembly manufacturing;
- ✓ Qualification test planning;
- ✓ Prototype full-size fuel assembly irradiation testing, including post-irradiation examinations;
- ✓ Fuel qualification report;
- ✓ Fuel licensing.

Fig. 29. Process of innovative fuel and materials development and qualification.

Motivation and necessity of experimental support

- Researching and testing of the innovative fuels and materials;
- Validation of theoretical and development of empirical fuel behaviour models;
- Verification of the fuel performance codes developed for modelling nuclear fuel behaviour in NPP;
 - ⇒ Substantiation of innovative fuel behaviour under steady-state, transient and accident conditions using fuel performance codes;
- ⇒ Main task: Qualification of the innovative fuel or using standard fuel for new operational conditions.

Fig. 30. Motivation and necessity of experimental support.

In particular, the integral approach (see Figs. 31 and 32) used for fuel and material investigations in the Halden reactor can be used in support of qualification and certification of fuel and materials to be introduced in the evolutionary LWRs of possible interest for Italy.

Integral fuel investigation

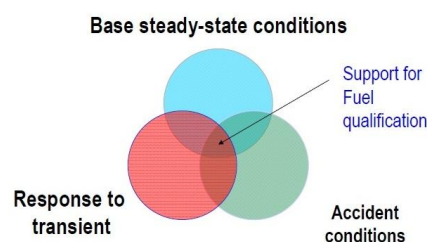

Fig. 31. Integral fuel investigation.

Integral approach for fuel and cladding testing in the Halden reactor

- **Base irradiation tests to investigate:**
 - fuel dimensional characteristics – densification and swelling
 - thermal performance and fuel conductivity
 - fission gas release (FGR)
 - PCI and PCMI
 - Cladding corrosion and CRUD deposition
- **Simulation of operational transients:**
 - Pellet – cladding interaction with assist corrosion
 - Ramp test to investigate fuel failure limit at transients
 - Transient FGR - load follow tests
- **Test simulating LOCA and dry-out conditions**
 - investigation of cladding ballooning
 - study of fuel relocation into the balloon area
 - cladding high temperature oxidation and embrittlement
 - dry-out tests with reduction of coolant flow
- **Special tests:**
 - Cladding creep tests (in-pile diameter measurements)
 - Gas flow measurements with gamma spectroscopy
 - Lift-off test with hydraulic diameter measurements.

Fig. 32. Integral approach for fuel and cladding testing in the Halden reactor.

In the sequel, some examples of R&D programmes for evolutionary LWRs of possible interest in Italy are presented, in close connection with the next HRP Programme (2012-2014) and the typology of tests (see Fig. 33) that can be performed at the HBWR facilities. More specifically, reference is made to the following areas:

- studies related to gas release under irradiation;
- thermo-mechanical studies;
- studies on the fuel behaviour under demanding operation conditions and accident scenarios;
- studies on innovative fuels and claddings;
- studies on plant ageing and degradation.

Tests performed in the Halden reactor

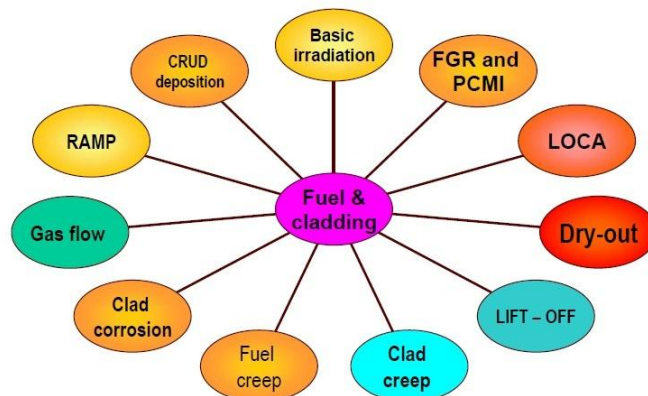

Fig. 33. Tests performed in the Halden reactor.



Studies related to gas release under irradiation

A possible programme in this area could be aimed at:

- extending the data base of on-set and kinetics of FGR in LWR fuels;
- studying the effects on FGR of fuel rod variables – additives, burnable poison, innovative fuel types, fill gas pressure;
- studying the effects on FGR of operational conditions – temperature, power, power cycling/load follow and burn-up;
- exploring the production and release of helium in MOX fuel rods;
- expanding the data base on the consequences of long and short term operation with rod overpressure as well as the influence of cladding type, burn-up level (extent of fuel-clad bonding) and operational parameters (e.g., load or temperature changes);
- studying gas release behaviour of fuel or fuel samples with well developed high burn-up structure.

Thermo-mechanical studies

In this area, investigations and analyses could be envisaged in order to:

- expand the database of fuel thermal conductivity and its degradation with burn-up;
- expand the database of PCMI behaviour at different exposures;
- provide new performance data on modified and innovative fuel;
- generate more data on the behaviour of production line gadolinia fuel;
- provide long term measurements on PCMI behaviour and rod growth rate due to fuel swelling and fuel-clad bonding;
- produce direct measurements of in-pile creep of UO₂, MOX and Gd-fuel.

This programme should be achieved by using fresh fuels as well as irradiated and re-fabricated fuel segments from PWRs and BWRs.

Studies on the fuel behaviour under demanding operation conditions and accident scenarios

In this huge area, possible investigations should be finalised to:

- characterise creep behaviour of modern LWR cladding materials under a range of representative compressive and tensile hoop stress levels;
- determine oxide thickness and hydrogen pick-up rates for modern PWR cladding materials under elevated Li water chemistry conditions (e.g., 10 ppm Li, pH₃₀₀=7.4);
- develop both miniaturized electrochemical corrosion potential (ECP) Pt-electrodes and on-line oxide thickness probes (based on eddy current) – see subsection 3.2 – in order to

improve the on-line corrosion measurements on Zircaloy-2 and Zircaloy-4 claddings under LWR conditions;

- study the onset of FGR and PCMI for high burn-up fuel rods from commercial LWRs;

In particular, as far as LOCA tests are concerned, the following issues could be addressed:

- determination of the impact of axial gas transport on ballooning, e.g. by including a spacer grid between the upper plenum and the balloon area that would act as a prototypical distension restriction and cooling and cooling improvement similar to what can be expected in the real situation;
- investigation of fuel relocation as influenced by the driving force provided by the amount of gas available in the experiments.

For this last purpose, the following activities could be envisaged in order to:

- fabricate and instrument segments for LOCA experiments with high burn-up fuel;
- measure and quantify the iodine released from the test fuel;
- carry out non-destructive and destructive PIE on the test segments after test execution.

Studies on innovative fuels and claddings

In addition to the improved fuels and claddings being developed to withstand the challenges to fuel integrity previously described, innovative materials (see Figs. 34 and 35) are also being looked into as an option for fuels and cladding to be employed in evolutionary LWRs.

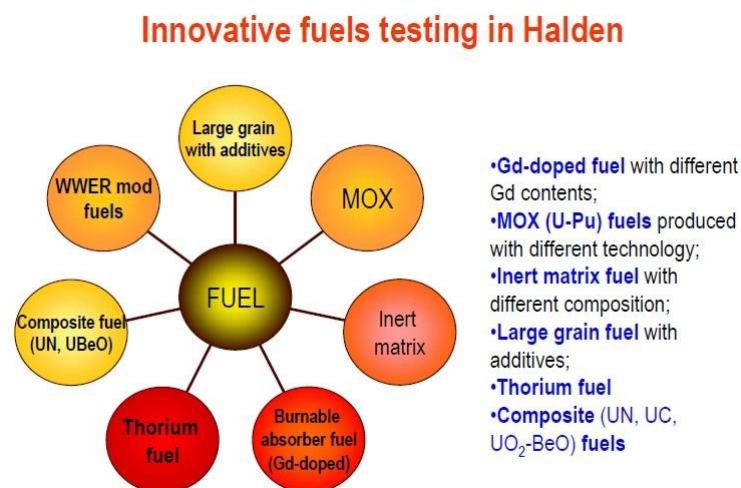

Fig. 34. Innovative fuels testing in Halden.

For each kind of these innovative materials, a huge experimental campaign (including both separate effects and integral in-pile performance testing, with reliable measurements provided by

Halden instrumentation under different conditions), and supported by modelling activities, is necessary in order to fully characterise the behaviour in-reactor for use in design and licensing.

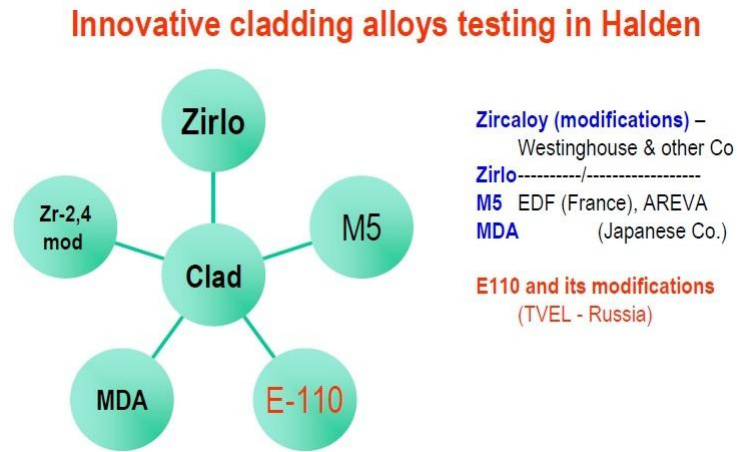

Fig. 35. Innovative cladding alloys testing in Halden.

Studies on plant ageing and degradation

In this area, investigations and analyses could be addressed to study the effects of irradiation on reactor vessel internals as the age of operating nuclear power plants increases, and in particular the following issues:

- irradiation assisted stress corrosion cracking (IASCC) of core component structural materials;
- irradiation enhanced creep and stress relaxation;
- reactor pressure vessel (RPV) embrittlement.

As to IASCC, the R&D activities should concern the following four inter-related areas: (i) crack growth rate studies; (ii) crack initiation (integrated time to failure) studies; (iii) effectiveness of ageing and degradation countermeasures; and (iv) irradiated materials characterisation. In particular, a possible programme could be aimed at:

- measuring the crack growth rate on CT specimens (prepared from core component materials with a range of dose levels) as a function of the several influencing variables (i.e., temperature, stress and corrosion potential);
- assessing the effects of water chemistry changes on crack initiation and growth behaviour;
- determining the effects of water chemistry, load and dose on time-to-failure in crack initiation studies;
- assessing post irradiation heat treatments in ameliorating IASCC susceptibility;



- performing a thorough characterization of the irradiated material microstructure and the quantification of the extent of any radiation-induced segregation at the grain boundaries of the materials.

As far as irradiation enhanced creep and stress relaxation are concerned, the following activities could be envisaged in order to:

- provide baseline creep and stress relaxation data on austenitic stainless steels and Ni based alloys commonly employed in LWRs;
- identify candidate replacement materials that exhibit superior creep / stress relaxation properties;
- measure irradiation enhanced creep and stress relaxation of replacement materials under different load / temperature / dose levels.

Finally, RPV integrity studies could be improved by means of:

- the adoption of miniature tensile specimens prepared from RPV materials (RPV wall materials and RPV internals in the reactor), which reduces the amount of material required to determine the basic mechanical properties of a material, and increase the reliability and the precision of the results from SPT (small punch test) specimens;
- the assessment of the dose rate effect on real RPV materials, in the context of dedicated Advanced Surveillance Specimen Programs able to provide knowledge about material degradation in the reactor core under higher neutron fluence.

4.2 Instrumentation & Control area

Within the framework of the Halden Project, instruments have been developed to allow in-core measurements of most fuel parameters, namely fuel temperature, fission gas release, fuel swelling, cladding elongation and cladding diameter. While these instruments have shown to perform very well in the core of a nuclear reactor, further developments of these instruments are continuously ongoing. These developments are aimed at increasing the accuracy, extending the operating temperature and pressure range and simplifying the design where possible. In addition, completely new in-core instruments (such as the eddy-current based oxide thickness probe) and miniaturized reference electrodes for material corrosion studies are being developed, showing very promising results.

In this area (in-core instrumentation, see Fig. 36), as well as in the area concerning the physics-based models/methods for condition monitoring, for plant-wide sensor validation, for remaining useful life estimation as well as for cable aging assessment, several R&D programmes of possible interest in Italy can be envisaged for the evolutionary LWRs, on the basis of the results presented in

subsection 3.2. These R&D programmes should be closely connected to the next HRP Programme (2012-2014).

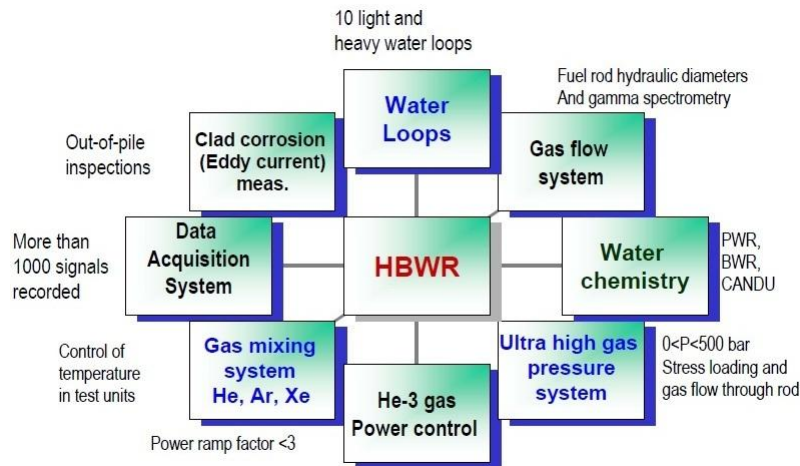

Fig. 36. In-core instrumentation and external systems used for fuel and material tests.

In addition to the previously arguments of I&C, the transition from analogue to digital technology is also an important aspect to be considered in the framework of possible Italian R&D activities, as shortly discussed here below with reference to next HRP research programmes in this area.

Traditionally, analogue systems performed the functions important to safety of a nuclear power plant. While many of these systems are still in operation, it is a well-known fact that the nuclear industry, like other industries, is moving to digital-based systems for instrumentation and control. These systems are used for monitoring, control, and protection. The motivation behind the transition to digital systems is manifold, where discontinued support of analogue systems is only one of several factors. Digital I&C systems are not experiencing the aging behaviour that is typical of analogue systems; have improved system performance in terms of accuracy and computational capabilities; have higher data handling and storage capabilities, and thus potentially provide the basis for more effective approaches to achieve high reliability; and are essentially free of the drift that afflicts analogue systems. There has, however, also been a certain reluctance to use programmable equipment in safety critical systems. Reasons for this have been the complexity of the safety assessment and the licensing of the software in these systems. Software dependability has therefore been a main research topic at the Halden Reactor Project since the 1970s. Particular emphasis has been placed on software in safety critical systems.

The HRP activities on digital systems safety pertain to a wide variety of computer-based systems important to safety, including protection systems, interlock systems, information systems, and many



others. An important concern is the successful introduction of pre-developed software in NPPs. The overall objective of the HRP's research programme on digital systems safety has been, and still is, to contribute to successful introduction of such systems into nuclear power plants.

The question is: how to argue that the systems are safe enough? Different levels of dependability (or reliability, correctness, or quality) requirements will be applied to different categories of systems and types of software, and different choices of applied technological solutions introduce different challenges related to the complexity of a system or a combination of systems. In addition, digital I&C systems relates not only to the initiation of safety related actions, but also to many different aspects related to the safe operation of a nuclear power plant (e.g., an information system failure may produce erroneous information related to the initiation of a safety system, and a data communication system failure may corrupt signals transmitted between different systems or components).

The I&C safety research at HRP will address four main topics related to the introduction of digital I&C: dependable requirement engineering, qualitative dependability assessment, fault tolerance and error propagation, and quantitative dependability assessment. For each of these some of the following types of software components or applications will be addressed, e.g.: integrated tool environments, autonomous systems, multi-core systems, adaptive systems, operating systems, and compound software. This is indicated in the Fig. 37, but note that this indication is an issue for further refinement and changes. The programme will also address the use of open source systems and pre-developed software. It reflects the fact that dependability factors such as safety, reliability and security, are important parameters both on a macro-level, addressing all the different phases of a system's lifecycle and covering risk analysis and assessment as an integrated part of all the phases, and on a micro-level addressing the software components

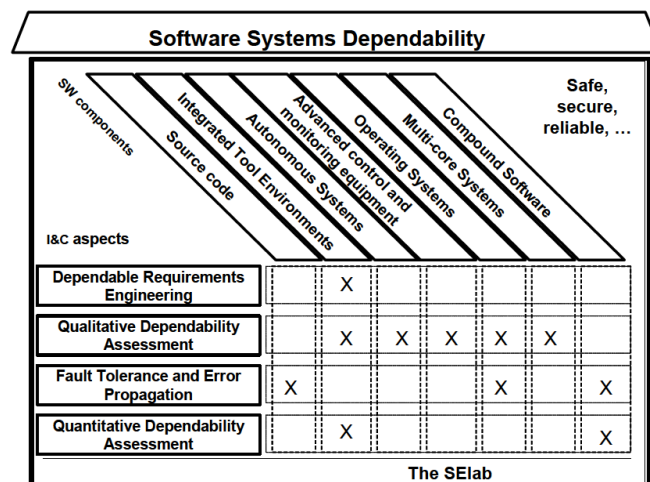

Fig. 37. Software systems dependability.



ACRONYMS

BWR	Boiling Water Reactor
CBM	Condition-Based Maintenance
CGR	Crack Growth Rate
CM	Condition Monitoring
CT	Compact Tension specimen
DBE	Design Basis Event
DC	Direct Current
DG	Diameter Gauge
EAB	Elongation At Break
ECP	Electrochemical Corrosion Potential
ECR	Equivalent Cladding Reacted limit
EdF	Électricité de France
EPRI	Electric Power Research Institute
EQ	Environment-Qualified
ET	Expansion Thermometer
F&M	Fuels & Materials
FGR	Fission Gas Release
FT	Fuel Thermocouple
GRS	Gesellschaft Für Reaktorsicherheit
HAMBO	HAMmlab BOiling water reactor
HAMMLAB	HAlden Man Machine LABoratory
HBS	High Burn-up Structure
HBWR	Halden Boiling Water Reactor
HF	Human Factor
HP	Halden Project
HPG	Halden Programme Group
HRP	Halden Reactor Project
HSE	Health and Safety Executive
HSI	Human System Interface
IASCC	Irradiation Assisted Stress Corrosion Cracking
I&C	Instrumentation & Control
IFE	Institut For Energiteknikk
IO	Integrated Operations
JAEA	Japan Atomic Energy Agency
KAERI	Korea Atomic Energy Research Institute
LIRA	LIne Resonance Analysis
LOCA	Loss-Of-Coolant Accident



LVDT	Linear Variable Displacement Transducer
MOX	Mixed OXide fuel
MTO	Man Technology Organisation
NDT	Non-Destructive Testing
NEA	Nuclear Energy Agency
NMR	Nuclear Magnetic Resonance
NPP	Nuclear Power Plant
NRI	Nuclear Research Institute
OECD	Organisation for Economic Cooperation and Development
OIT	Oxidation Induction Time
OLM	On-Line Monitoring
PCMI	Pellet-Clad-Mechanical-Interaction
PIE	Post-Irradiation Examination
PWR	Pressurized Water Reactor
QC	Qualified Condition
QL	Qualified Life
RF	Radio Frequency
RPV	Reactor Pressure Vessel
RUL	Remaining Useful Life
SCK-CEN	StudieCentrum voor Kernenergie - Centre d'Etude de l'énergie
SLC	Safety Limit Condition
SPT	Small Punch Test
TDR	Time Domain Reflectometry
U.S. NRC	United States Nuclear Regulatory Commission
VIT	Visual Interface Technologies
VRC	Virtual Reality Centre
VUJE	Vyskumny Ustav Jadrovych Elektrarni
VVER	Vodo-Vodyannoy Energeticheskiy Reactor

PARTE III

**POTENZIALITÀ' DEL REATTORE HALDEN:
POSSIBILITÀ' SIMULAZIONE DI INCIDENTI TIPO LOCA E RIA
(UNIVERSITA' DI PISA_SPG)**



CIRTEN

Consorzio Interuniversitario per la Ricerca Tecnologica Nucleare

UNIVERSITY OF PISA

San Piero a Grado Nuclear Research Group

Rapporto potenzialità reattore HRP con review Fuel & Materials e definizioni programma di R&S di più specifico interesse nazionale a supporto dei reattori LWR evolutivi

**POTENZIALITÀ DEL REATTORE HALDEN:
POSSIBILITÀ SIMULAZIONE DI INCIDENTI TIPO LOCA E RIA**

Autori

**Martina Adorni
Francesco D'Auria**

CERSE-UNIPI RL 1090/2011

PISA, LUGLIO 2011

Lavoro svolto in esecuzione della linea progettuale LP1 punto C
AdP MSE - ENEA "Ricerca di Sistema Elettrico" - PAR2008-09
Progetto 1.3 – "Nuovo Nucleare da Fissione".

This page intentionally left blank

Sommario

Il presente lavoro è svolto nell'ambito dell'Accordo di Programma MSE-ENEA sulla Ricerca di Sistema Elettrico, Piano Annuale di Realizzazione 2008-2009, per quanto attiene all'Area "Governo, gestione e Sviluppo del Sistema Elettrico Nazionale", tematica di ricerca "Energia Nucleare"; nello specifico, si riferisce agli obiettivi del progetto 1.3 "Nuovo Nucleare da Fissione: collaborazioni internazionali e sviluppo competenze in materia nucleare".

Il rapporto è preparato allo scopo di documentare le attività svolte per la prima linea progettuale in cui è suddiviso l'accordo stesso: "studi sul nuovo nucleare e partecipazioni ad accordi internazionali/bilaterali sul nucleare da fissione". Nello specifico è preparato come deliverable della sezione LP1-C: partecipazione al progetto internazionale OECD-NEA "Halden Reactor Project" che prevede la preparazione di due relazioni, che saranno raccolte in un unico documento congiunto ENEA-POLIMI-UNIPI/GRNSPG così suddivisi:

LP1-C.1 Rapporto potenzialità reattore HRP e MMI Labs con review Fuel&Materials e Instrumentation &Control per reattori LWR evolutivi.

LP1-C.2 Rapporto definizione programmi di R&S di più specifico interesse nazionale a supporto dei reattori LWR evolutivi, in entrambi i settori Fuel&Materials e Instrumentation&Control.

In particolare il presente documento è preparato come deliverable LP1-C.1

Il rilancio della partecipazione italiana al "Halden Reactor Project" dell'OECD-NEA, centro internazionale di eccellenza nel dominio *Fuel&Materials e Instrumentation and Control*, è svolto nell'intento di ricostituire/sviluppare competenze nei due specifici settori, a supporto del licensing ed esercizio dei reattori LWR di III Generazione che, nella prospettiva pre-Fukushima e referendum del giugno 2011, il programma nucleare nazionale prevedeva essere installati in Italia nel corso dei prossimi 20 anni.

Temi di particolare attenzione sono il comportamento del combustibile e materiali strutturali in condizioni di alto *burn-up* e lunghi tempi di residenza in reattore, insieme alle tecnologie di *Instrumentation&Control*.

Il presente documento, dopo una breve introduzione, descrive l'impianto di Halden, con particolare attenzione al sistema del reattore, la configurazione del nocciolo e lo stato dell'impianto. La terza sezione è dedicata alla possibilità di eseguire test sul combustibile nel reattore.

La quarta sezione fornisce qualche nota relativa ai metodi di licenziamento, con particolare attenzione all'importanza degli esperimenti e la modellazione e fornendo anche una panoramica dei criteri sicurezza per combustibile nucleare e l'approccio "*best estimate*". L'ultimo paragrafo è dedicato all'importanza di sviluppare l'"*engineering handbook*" per la modellazione del combustibile. La quinta sezione descrive i fenomeni e processi rilevanti per i transitori incidentali quali LOCA e RIA.

L'ultima sezione contiene una proposta per sviluppare un programma sperimentale di interesse nazionale. La pianificazione proposta è inserita per fornire informazioni di massima sui tempi necessari per sviluppare un programma del genere. Un raffinamento sarà necessario al fine di pianificare più in dettaglio l'esperimento desiderato. Infine, le conclusioni sono riportate nell'ultima sezione.

Index

LIST OF FIGURES	4
LIST OF TABLES	5
1 INTRODUCTION	6
2 DESCRIPTION OF THE HALDEN REACTOR	7
2.1 GENERAL INFORMATION	7
2.2 REACTOR SYSTEM	8
2.3 CORE CONFIGURATION	9
2.4 PLANT STATUS	10
3 FUEL TEST PROGRAM	12
3.1 BASE IRRADIATION EXPERIMENTAL SETUP	13
3.2 IRRADIATION EXPERIMENTAL SETUP	14
3.3 POST IRRADIATION EXAMINATIONS	14
3.4 POSSIBLE OUTCOMES	15
4 LICENSING APPROACH	17
4.1 IMPORTANCE OF EXPERIMENTS AND MODELING	17
4.2 OVERVIEW OF FUEL SAFETY CRITERIA	17
4.3 OVERVIEW OF BEST ESTIMATE APPROACH DEVELOPED AT UNIPI	18
4.4 ENGINEERING HANDBOOK FOR FUEL MODELLING	18
5 SEVERE TRANSIENTS: PHENOMENA AND PROCESS RELEVANT TO LOCA&RIA	25
5.1 HEAT TRANSFER	26
5.2 BURNUP	26
5.3 FAILURE	27
5.4 GAS FLOW	27
5.5 ANISOTROPY OF THE CLADDING	28
5.6 OXIDATION	28
5.7 FUEL FRAGMENTATION AND RELOCATION	28
6 PROPOSAL FOR AN EXPERIMENTAL PROGRAM OF NATIONAL INTEREST	32
7 CONCLUSIONS	34
REFERENCES	35

List of figures

FIG. 1 – SIMPLIFIED SKETCH OF THE REACTOR.	8
FIG. 2 – SIMPLIFIED FLOW SHEET OF THE REACTOR SYSTEM.	8
FIG. 3 – TYPICAL CORE MAP.	9
FIG. 4 – TYPICAL TEST RIG.	9
FIG. 5 – SIMPLIFIED DRAWING OF THE LOOP, IFA-650.6 TEST.	16
FIG. 6 – EXAMPLE OF GAMMA SCANNING DURING LOCA TEST, REF. [18].	16
FIG. 7 – PARAMETERS INFLUENCING THE GAP CONDUCTANCE ACCORDING TO G.R. HORN, QUOTED BY BEYER ET AL. REF. [30].	19
FIG. 8 – EXAMPLE OF INTERACTION BETWEEN CODES, REF. [22].	20
FIG. 9 – SAMPLE OF THE TABLE USED TO DOCUMENT THE INPUT DECK FROM REF. [32].	20
FIG. 10 – SCHEMATIC ILLUSTRATION OF FAILURE MODES DURING LOCA TRANSIENTS, REF. [18].	29
FIG. 11 – SCHEMATIC ILLUSTRATION OF TWO TYPES FAILURE MODES IN EARLY AND LATE PHASES OF RIA TRANSIENTS, REF. [19].	29
FIG. 12 – SCHEME OF FAILURE MODES DURING COMBINED LOCA AND RIA, REF. [22].	30
FIG. 13 – POSSIBLE MECHANISMS FOR FUEL AND CLADDING DAMAGE UNDER A RIA, REF.[17].	30
FIG. 14 – EXAMPLE OF JAPANESE FUEL FAILURE THRESHOLD FOR PCMI, REF. [18].	31
FIG. 15 – SCHEMATIC VIEW OF IFA-652 TEST-RIG (TEST RIG FOR BURNUP ACCUMULATION), REFS. [39], [40].	33
FIG. 16 – TEST RIG FOR TRANSIENT TESTING LAYOUT, REF. [22].	33

List of tables

TAB. 1 – NOMINAL REACTOR OPERATING DATA. _____ 9

TAB. 2 – HBWR REACTOR CHARACTERISTICS. _____ 10

TAB. 3 – FUEL SAFETY CRITERIA FROM REF. [27]. _____ 21

TAB. 4 – SPECIFIC ACCEPTANCE CRITERIA FOR DESIGN BASIS ACCIDENTS FROM REF. [26]. _____ 22

TAB. 5 – NORMAL OPERATION: SUMMARY OF RELEVANT PARAMETERS FOR VALIDATION FROM REF. [22]. _____ 23

TAB. 6 – ACCIDENT CONDITIONS: SUMMARY OF RELEVANT PARAMETERS FOR VALIDATION FOR THE LOCA ANALYSIS FROM REF. [22]. ____ 23

TAB. 7 – ACCIDENT CONDITIONS: SUMMARY OF RELEVANT PARAMETERS FOR VALIDATION FOR THE RIA ANALYSIS FROM REF. [22]. ____ 24

TAB. 8 – PROPOSED TIME SCHEDULE OF THE PROJECT. _____ 33

1 Introduction

Phenomena involved during heat-up, cooldown and quench during a LOCA scenario are very complex and comes from the changes of properties of the zirconium cladding alloys which take place during the transient. Furthermore, main safety concerns in RIA scenario, such as loss of long-term core coolability and possible damage to the reactor pressure boundary and the core through pressure wave generation should be investigated in detail.

To date, more than a thousand pulse irradiation tests have been carried out on fresh fuel rods, and about 140 tests have been done on pre-irradiated samples. Experimental database currently developed addressing LOCA and RIA can be found in Refs. [1] to [8].

To perform such testing, there is the need to perform experiments beyond cladding failures. A small percentage of the research reactors in operation are suitable to perform experiments beyond cladding failure. Moreover, the specific features of such experiments require the capability to measure the fuel rods parameters in both failed and not failed conditions and there availability of appropriate facilities to treat irradiated material. Usually these testing are performed in rigs that are specifically designed for the experiments.

After a brief introduction, the description of the Halden reactor is reported, focusing on the reactor system, the core configuration and the plant status. The third section is dedicated to the possibility to perform fuel testing in the reactor.

Section four provide some notes related to the licensing approach, focusing on the importance of experiments and modeling and providing also an overview of the existing fuel safety criteria and the best estimate approach. The last paragraph is dedicated to the importance to develop an engineering handbook for the fuel modeling.

Section five describes the phenomena and process relevant to severe transients such as LOCA and RIA.

The last section contains a proposal for an experimental program of national interest. The proposed time schedule is inserted as well just to provide rough information about the timing needed to develop such a program. Refinement should be certainly needed to match the desired experimental outcome.

Finally, conclusions are provided in the last section.

2 Description of the Halden reactor

The present section is dedicated to the description of the Halden reactor and its capabilities to perform experiments beyond failure of the fuel rods. The Project brings together an important international technical network in the areas of nuclear fuel reliability, integrity of reactor internals, plant control/monitoring and human factors.

The programme of work in the fuel and materials area includes fuel assessments in postulated accident conditions and investigations in the high and very high burn-up range (both under normal operating conditions and transients). The material work also encompasses the embrittlement and cracking behaviour of reactor internals materials. These investigations are carried out under representative reactor conditions using advanced instrumentation. Key programme areas are:

- fuel response to transients, such as loss-of-coolant accidents (LOCAs);
- high burn-up capabilities of fuel under normal operating conditions;
- fuel reliability issues;
- plant lifetime assessments (reliability of internals).

The 2009-2011 work programme in the nuclear fuel area includes important loss-of-coolant accident (LOCA) tests carried out with high burn-up fuel. These are the only LOCA tests that are currently performed in-pile worldwide, and complement the work done on a laboratory scale in other institutions. The tests carried out in 2009 have provided valuable insights which need to confirm evidence in hot cell post-irradiation examinations. Properties of UO₂, gadolinia and MOX fuels in a variety of conditions relevant to operation and licensing were investigated during 2009. Long term irradiations have been carried out with advanced and standard nuclear fuel at high initial rating conditions. Corrosion and creep behaviour of various alloys were studied. The experimental programme on the effect of water chemistry variants on fuel and reactor internals materials has been expanded. Tests to investigate the cracking behaviour of reactor internals material in boiling water reactors and pressurised water reactors continued, with the aim of characterising the effect of water chemistry and material ageing.

The programme on human factors focused on tests and data analyses carried out in the Halden man-machine laboratory, encompassing new designs and evaluations of human-system interfaces and control rooms. This involves, *inter alia*, the use of the Halden Virtual Reality Facility. Progress has been made in the area of human reliability assessment, aiming to provide data suitable for probabilistic safety assessments. The work on cable ageing has resulted in a technique that is being used at an industrial level to assess whether cable insulation is damaged, and in those cases to determine the extent and location of the damage, Ref. [3].

2.1 General information

The Halden Boiling Heavy Water Reactor (HBWR) is in operation since 1959 in Halden, a coastal town in south-east Norway near to the border to Sweden. The reactor vessel primary circuit system is inside a rock cavern. Heat removal circuits are either placed inside the reactor hall or in the reactor entrance tunnel. Control room and service facilities are placed outside the excavation. The utilization of the reactor is 24 hours per day, 7 days per week, 28 weeks per year producing 4000 MWdays/year, Refs. [10], [11].

2.2 Reactor System

The Halden Boiling Heavy Water Reactor (HBWR) is a natural circulation boiling heavy water reactor, Fig. 1. The maximum power is 25 MW (thermal), and the water temperature is 240°C, corresponding to an operating pressure of 33.3 bar. Pressurization tests are performed at regular intervals using a pressure of 40 bars. Fig. 2 shows a simplified flow sheet of the reactor system.

The reactor pressure vessel is cylindrical with a rounded bottom. It is made of carbon steel and the bottom and the cylindrical portion are clad with stainless steel. The flat reactor lid has individual penetrations for fuel assemblies, control stations and experimental equipment. 14 tons of heavy water act as coolant and moderator. A mixture of steam and water flows upwards by natural circulation inside the shroud tubes which surround the fuel rods. Steam is collected in the space above the water while water flows downwards through the moderator and enters the fuel assemblies through the holes in the lower ends of the shroud.

The steam flows to two steam transformers where heat is transferred to the light water secondary circuit. Condensate from the steam transformers returns to the reactor by gravity. An external subcooler loop is installed to provide experimental variation of void fraction in the fuel assemblies and the moderator, and is also used for heating and cooling purposes. In the secondary circuit, two circulation pumps pass the water through the steam transformers, a steam drum and a steam generator where steam is produced in the tertiary circuit. The tertiary steam is normally delivered as process steam to the nearby paper mill, but may also be dumped to the river. There is generally no access to the reactor hall when the reactor is operational, and therefore all control and supervision is carried out from the control room.

Light water, high pressure loops provide facilities for testing under prototypic BWR and PWR conditions. Nominal power operating data are outlined in Tab. 1.

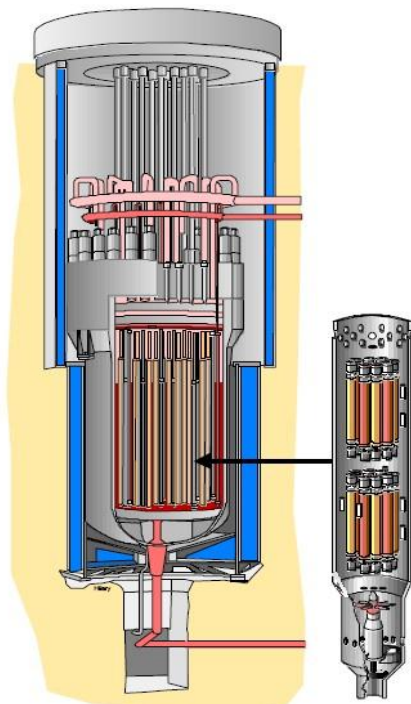

Fig. 1 – Simplified sketch of the reactor.

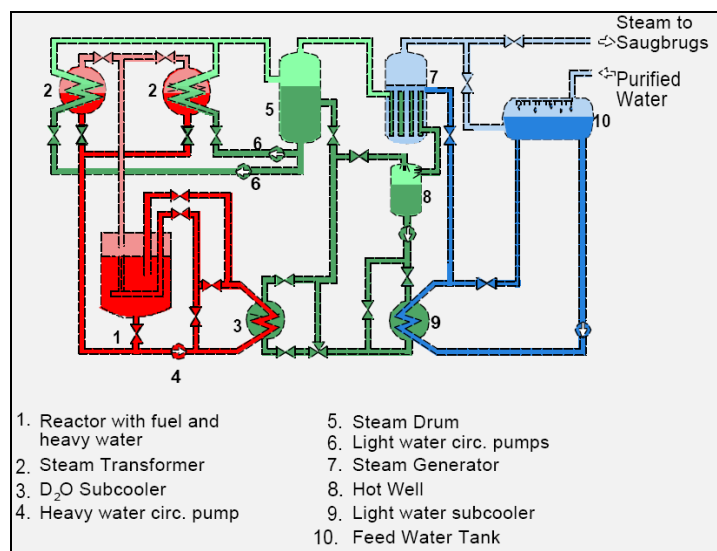

Fig. 2 – Simplified flow sheet of the reactor system.

Nominal Reactor Operating Data	
Power Level	up to 20 MW (th)
Reactor Pressure	33.3 bar
Heavy Water Saturation Temperature	240°C
Maximum Subcooling	3.0 MW
Primary Steam Flow (both circuits)	160 ton/h
Return Condensate Temperature	238°C
Subcooler Flow	160 ton/h
Plenum Inlet Temperature	237°C

Tab. 1 – Nominal reactor operating data.

2.3 Core Configuration

The core consists of about 110 - 120 fuel assemblies, including the test fuel, in an open hexagonal lattice with a lattice pitch of 130 mm. 30 lattice positions are occupied by control stations. The maximum height of the fuel section is 1710 mm, and the core is reflected by heavy water. Selected core data are given in Tab. 2 and Fig. 3 shows a typical core map. The central position in the core is occupied by an emergency core cooling tube with nozzles, and between eight and fourteen core positions contains pressure flasks for light water, high pressure test loops.

Test rig for determining the consequence of short-term dryout is reported in Fig. 4. The tests can be performed as follow. Three pre-irradiated, commercial fuel rodlets, after service in a reactor, are re-fabricated, instrumented and loaded into this rig. Each subchannel which contained one fuel rod, can be individually operated at reduced coolant flow conditions, producing dryout in the upper portion of the fuel rod.

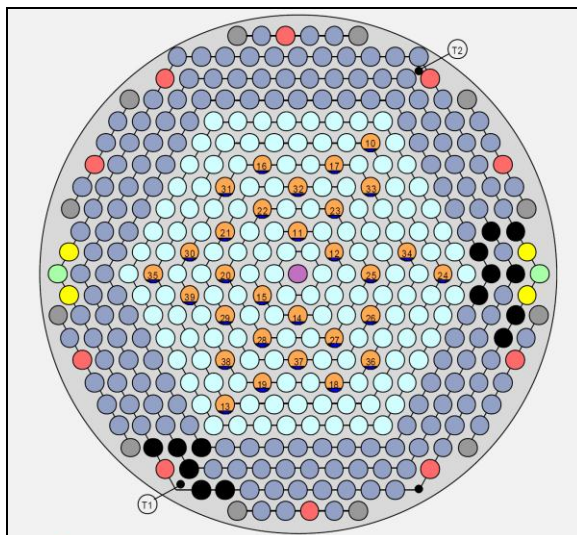

Fig. 3 – Typical core map.

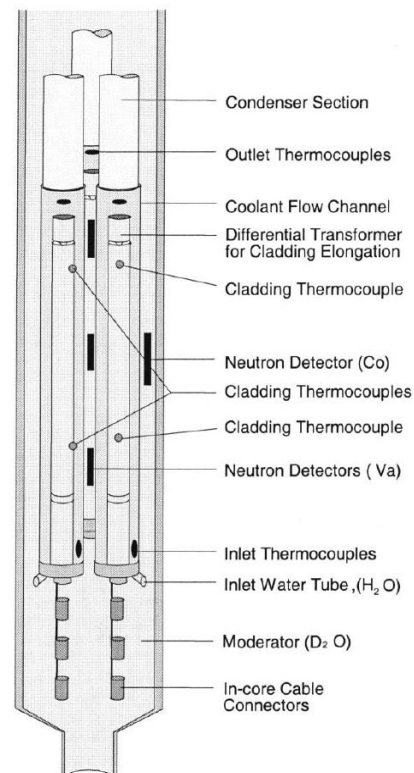

Fig. 4 – Typical test rig.

Technical Data	
Reactor Type	Heavy Water
Thermal Power, Steady (kW)	20,000.00
Max Flux SS, Thermal (n/cm ² -s)	1.00E+14
Max Flux SS, Fast (n/cm ² -s)	1.00E+14
Moderator	Heavy water
Coolant	Heavy water
Natural Convection Cooling	YES
Forced Cooling	YES
Coolant Velocity in Core	1-3 m/s
Reflector	D2O
Reflector Number of Sides	4
Control Rods Material	Ag,Cd,Al
Control Rods number	30
Experimental Facilities	
Vertical Channels	300
Vertical Max Flux (n/cm ² -s)	1.00E+14
Vertical Use	Fuel & core material performance studies
Core Irradiation Facilities	40
Core Max Flux (n/cm ² -s)	1.00E+14
Reflector Irradiation Facilities	5
Loops Number	04-ago
Loops Max Flux	1.00E+14
Loops use	Fuel & core material studies: BWR, PWR condit.
Fuel data	
Equilibrium Core Size	100-110
Rods per Element	8
Dimensions of Rods, mm	9-14 DX800
Tubes per Element	1
Dimensions of Tubes, mm	Shroud 71 OD.
Cladding Material	ZR
Cladding Thickness, mm	0.6-0.8 PWR,BWR
Fuel Thickness, mm	8-12 diameter
Uranium Density, g/cm ³	10.5
Burnup on Discharge, max %	VAR
Burnup Average, %	40 MWd/kg (Driver El
Fuel Fabricator	Institutt for Energiteknikk, Norway
Utilization	
Hours per Day	24
Days per Week	7
Weeks per Year	28
MW Days per Year	4000
Materials/fuel test experiments	Number of runs: 35

Tab. 2 – HBWR reactor characteristics.

2.4 Plant Status

The design working pressure of the HBWR pressure vessel is 40 bar with a saturation temperature of 250°C. The hydraulic acceptance pressure test was carried out at 54 bar, 35 % above the design pressure. The normal operating pressure is 33.3 bar, with corresponding saturation temperature of 240°C. The stresses in the vessel are low compared with the code requirements. Thermal stresses are also normally low. There are normally 2-3 main shutdowns

per year, dictated primarily by the experimental programs and a few additional cooling downs for special tests. The normal heating and cooling rates are 10°C/h. Inspection and recertification pressure tests are performed every 3rd year at 10 % overpressure. These pressure tests are performed with water/steam at saturation temperature. According to the requirements set by Norwegian Boiler Authority, the inspection and test programs include ultrasonic examination of vessel welds, lid, bolts, bottom nozzle and primary system piping, and evaluation of radiation induced material changes.

The outcome of the material testing, fluence evaluations, inspections, and pressure testing, form the basis for the assessments of vessel integrity. Internationally accepted codes, rules and recommendations are used in a consultative manner. The material tests and the analysis performed indicate that the reactor can be operated safely well beyond year 2020.

3 Fuel Test Program

The fuels testing program conducted in the Halden reactor (heavy boiling water reactor (HBWR)) is aimed at providing data for a mechanistic understanding of phenomena, which may affect fuel performance and safety parameters.

The investigations address:

- thermal property changes;
- fission gas release as influenced by power level and operation mode,
- fuel swelling, and
- pellet-clad interaction.

Relevant burnup levels (>50 MWd/kgU) are provided through long-term irradiation in the HBWR and through utilization of re-instrumented fuel segments from commercial light water reactors (LWR).

Both uranium and MOX fuels are being studied regarding thermal behavior, conductivity degradation, and aspects of fission gas release. Experiments are also conducted to assess the cladding creep behavior at different stress levels and to establish the overpressure below which the combination of fuel swelling and cladding creep does not cause increasing fuel temperatures. Clad elongation measurements provide information on the strain during a power increase, the relaxation behavior and the extent of a possible ratcheting effect during consecutive start-ups. Investigations include also the behavior of MOX and Gd-bearing fuel and other variants developed in conjunction with burnup extension programs. Some LWR-irradiated fuel segments will undergo a burnup increase in the HBWR to exposures not yet achieved in LWRs, while others will be re-instrumented and tested for shorter durations.

Investigations of fuel performance in steady state and transient operation conditions have constituted a major part of the experimental work carried out in the heavy boiling water reactor (HBWR) at Halden since its start-up in 1959.

The in-core studies were supported by the development and perfection of instrumentation and experimental rig and loop systems where reactor fuels and materials can be tested under PWR and BWR conditions.

Fuels testing at the Halden Reactor Project (HRP) have for a number of years focused on implications of extended burnup operation schemes aimed at an improved fuel cycle economy. The experimental programs are, therefore, set up to identify long-term property changes with an impact on performance and safety. While PIE ascertains the state existing at the end of irradiation, in-core instrumentation provides a full description of performance history, cross-correlation between performance parameters, on-line monitoring of the status of the test, and a direct comparison of different fuels and materials. Trends developing over several years, slow changes occurring on a scale of days or weeks, and transients from seconds to some hours can be monitored. The data generated in the fuels testing programs originate from in-pile sensors, which allow assessing:

- fuel centre temperature and thus thermal property changes as function of burnup;
- fission gas release as function of power, operational mode and burnup;
- fuel swelling as affected by solid and gaseous fission products;
- pellet-cladding interaction manifested by axial and diametral deformations.

The irradiation of instrumented fuel rods is carried out in specialized rigs according to test objectives, e.g. long-term base irradiation, diameter measurements or ramps and overpower testing.

When specific coolant conditions are required, such as for cladding and structural materials studies, water loops are available. The loops can be operated in different thermal-hydraulic and water chemistry conditions, covering a range of BWR and PWR requirements. Totally, 7 loops are currently in operation at the Halden reactor, serving 12 in-pile experiments. The distinctive specialty of the HBWR fuel and material experiments resides in the ability to perform high quality in-reactor measurements, which provide unique and well characterized data during operation; that is, while mechanisms are acting.

Fuel rods extracted from commercial reactors can be segmented and re-fabricated into rodlets suitable to further specialized testing at Halden. In addition to fuel instrumentation, some rods in experimental rigs have gas lines attached to their end plugs. This allows the exchange of fuel rod fill gas during operation and makes it possible to determine gas transport properties as well as the gap thermal resistance and its influence on fuel temperatures. It is also possible to analyze swept out fission products for assessment of structural changes and fission gas release. Other instruments required for the tests are also available. These operations and post irradiation examinations (PIE) can be carried out in the hot cells located at the Kjeller establishment. Other operations including non-destructive examinations can be performed in shielded compartments situated near the Halden reactor.

Similarly, structural materials extracted from LWR cores can be machined, fatigue pre-cracked if necessary and suitably instrumented for the Irradiation Assisted Stress Corrosion Cracking (IASCC). This technique is important in that it provides very representative materials already irradiated to doses typical of 'aged' plants. The experimental work is supported by the hot cells for re-fabrication and post-irradiation examinations, by workshops, electronics and chemistry laboratories and by a computerized data bank.

The national interest in the experiments, should be in the possibility to improve the knowledge on the consequences of severe transients on the fuel rods, such as power and/or temperature excursions to the fuel integrity, addressing:

- the failure limits;
- the failure mechanism and associated phenomena.

The experiment should provide also suitable data for modeling.

3.1 Base irradiation experimental setup

In the case the burnup accumulation is performed in the Halden reactor, a special test rig should be used. The layout of the test rig for the base irradiation is reported in Fig. 15 and can accommodate simultaneously a cluster of 3 to 6 instrumented fuel rods, depending on the dimensions.

The main operating parameters can be directly monitored. All the rods can be instrumented with:

- thermocouples to measure fuel centerline,
- cladding and coolant temperatures at different positions.

In addition, all the rods can be instrumented with:

- fuel and cladding rod elongation and
- internal pressure detectors.

An online gamma-detector can also be installed, to monitor activity release.

The test rig should be put into a pressure flask that constitutes the physical separation from the region where the experiment is performed and the HBWR moderator. The function of the pressure flask is to reproduce the thermal hydraulic conditions occurring during the selected accident conditions.

The selected burnup can be achieved with a LHR of about 40-60kW/m. The reactor irradiation cycles is approximately 90 full power days (FPD). Depending on the final burnup, more irradiation cycles should be needed.

When the burnup target is reached, the fuel rods will be transferred to the transient test rig. During the base irradiation it will be possible to reproduce the phenomena that can occur in the fuel during normal operation (e.g. PCI).

3.2 Irradiation experimental setup

Test of the fuel in severe conditions (LOCA and/or RIA) are performed in a test rig specifically designed to reproduce the conditions of the selected transient, Fig. 16. The test rig allows the irradiation of one rod per test.

Special features to reproduce power pulses test rig are the compensation fuel rods that can be inserted in the rig, in order to avoid the excess of reactivity changes in the HBWR core when performing the power pulse testing. These rods will be covered by the neutron shield when the fuel is uncovered.

Analogously for the base irradiation, the main operating parameters are directly monitored. All the rods are instrumented with thermocouples to measure fuel centerline, cladding and coolant temperatures at different positions. Anyway, the fuel centerline thermocouples are expected to fail towards the end of the severe transient due to the very high temperatures envisaged. In addition, all the rods can be instrumented with fuel and cladding rod elongation and internal pressure detectors. An online gamma-detector can also be installed, in order to monitor possible activity release.

The test rig is connected with a pressure flask, representing the pressure boundary between the HBWR moderator and the rig in order to reproduce the designed transient conditions. A simplified layout of the loop is presented in Fig. 5, which was used for the LOCA test IFA-650.6 already performed. During normal operation prior to the test, the rig is be connected to the loop.

3.3 Post Irradiation Examinations

Before irradiation and after burnup accumulation phase, in addition the online measurement, the dimensional measurements and visual inspections can be executed.

After completing the transient testing, the fuel rods can be shipped to Kjeller hot-laboratory for post irradiation examinations (PIE). The PIE can include:

- visual inspection (with photographs);
- dimensional measurements (diameter and length profiles);
- gamma scanning (for determining power profiles and/or dislocation of fuel), Fig. 6;
- leak-testing;
- characterization of fuel failures (if any); and
- metallography/ceramography (three cross sections for each rod).

3.4 Possible outcomes

A general overview of the issues that could be addressed during the experiment is listed below:

- failure mechanism and associated phenomena,
- thermal mechanical behavior changes:
 - pellet cracking,
 - fuel densification,
 - fuel swelling,
 - cladding creepdown,
 - cladding growth,
 - FGR,
- fission gas release as influenced by power level and operation mode,
- geometry changes in order to address the coolability issue (i.e. ballooning),
- pellet–clad interaction,
- fuel performance anomalies such as:
 - crude deposition as affected by water chemistry and heat rating,
 - axial offset anomalies caused by local boron accumulation on the surface of the fuel rods,
 - degradation of failed fuel resulting in large exposure of the fuel to the coolant and consequent increase of radiation level in the coolant,
 - control rod sticking as the result of axial growth of guide tubes during service,
- oxidation and hydrogen pick-up,
- maximum rod overpressure,
- start of ballooning (cladding deformation detected by rod pressure measurement),
- cladding failure,
- gap closure,
- fuel centre temperature and thus thermal property changes as function of burnup,
- fission gas release as function of power, operational mode and burnup,
- fuel swelling as affected by solid and gaseous fission products,
- pellet–cladding interaction manifested by axial and diametral deformations,
- rod pressure,
- corrosion of hydriding,
- stress corrosion cracking.

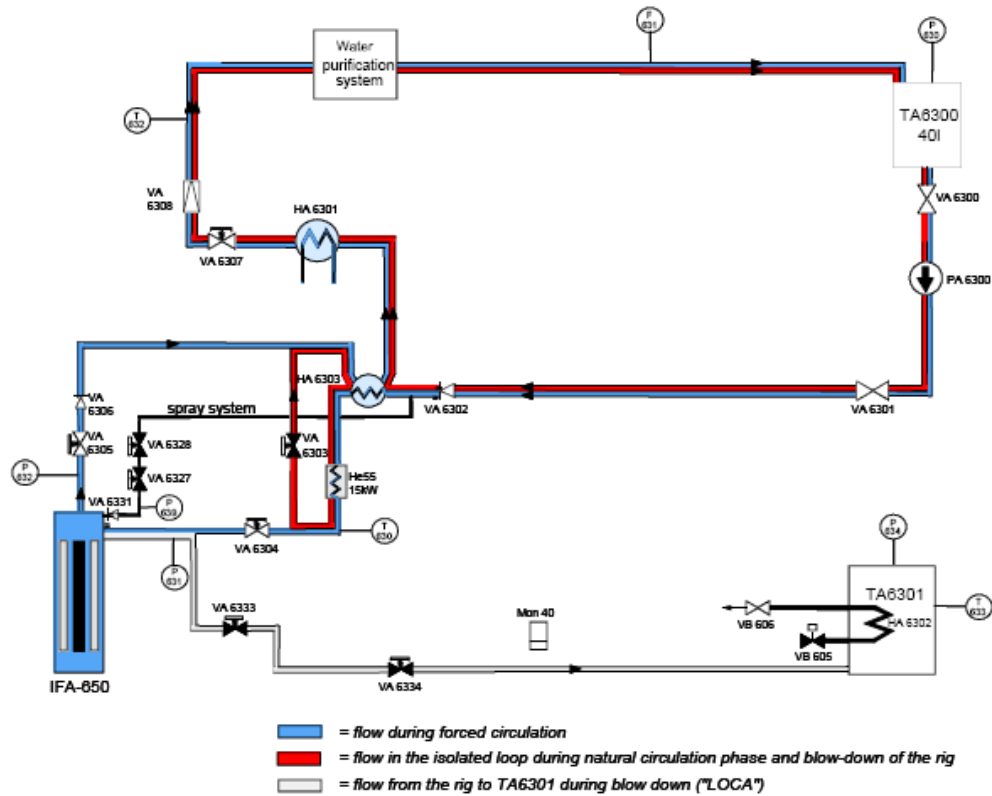

Fig. 5 – Simplified drawing of the loop, IFA-650.6 test.

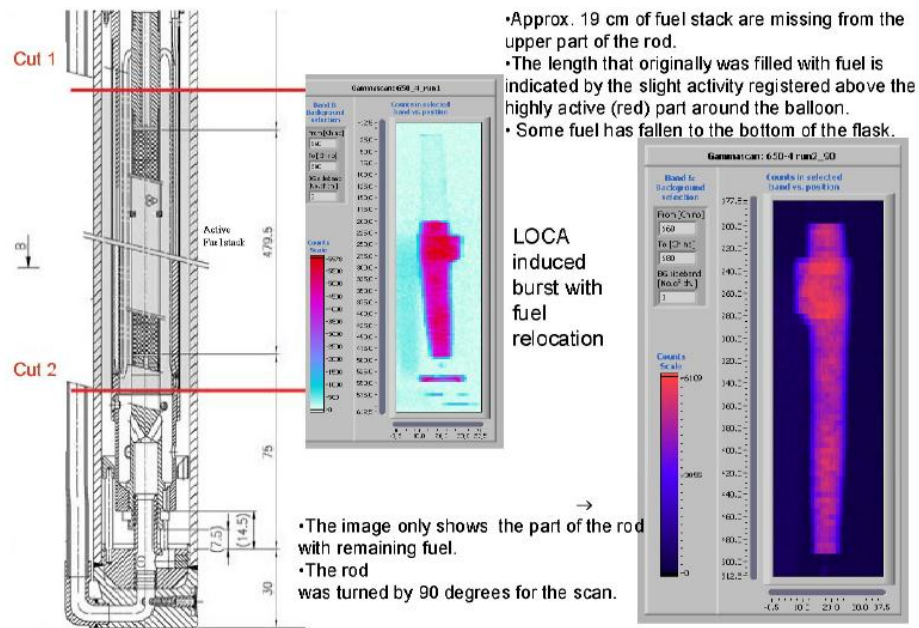

Fig. 6 – Example of gamma scanning during LOCA test, Ref. [18].

4 Licensing approach

4.1 Importance of experiments and modeling

The fuel rod constitutes the first barrier against the release of fission products. The accurate description of the fuel rod's performance is an interdisciplinary field. The fuel rod is operated under varying conditions, and it changes the physical and thermodynamic properties during irradiation, e.g. see Fig. 7. The capability of predicting its behavior and life-time, for a wide range of normal, off-normal and accident conditions (including limiting conditions, such as LOCA and RIA) constitutes an achievement in ensuring the safe and economic operation of nuclear power plants. The prediction of the fuel performance in safety analysis requires the use of “*ad hoc*” codes, well defined boundary and initial conditions (connections with thermal hydraulics, three dimensional neutron kinetics, and depletion codes) as well as appropriated and validated models, belonging to different physics' fields.

Investigations of fuel behavior are carried out in close connection with experimental research, operation feedback and computational analyses. In the last decades, a considerable world wide effort has been expended in experimental and numerical modeling of fuel rods behavior in accident conditions, which has led to a broader and deeper understanding of LOCA and RIA related phenomena. In this regard, a complementary, but not less important, activity is the validation of the fuel pin mechanics codes against experimental data available, to demonstrate the reliability of their predictions. In this connection, validation activities are performed to enhance the code capabilities and to improve the reliability of the code results.

An attempt to implement the connection between experiments and modeling was performed in the framework of Ref. [22]. For this aim, tables to be used for the validation were developed. Tab. 5, Tab. 6 and Tab. 7 report the parameters to be used for the validation with the indication, for the analyzed databases, if they are or are not suitable for code assessment. The tables differ for the normal operation and severe transients, e.g. LOCA and RIA. The last column of each table reports the indication of the judgment of occurrence or not in the selected NPP fuel. Additional references related to the importance of fuel modeling and its application in licensing can be found in Refs. [13], [14], [15] and [16]

4.2 Overview of fuel safety criteria

A review of the state of the art of the fuel experiments and modeling is out of the scope of this report. A number of references are available on this subject, Refs. [1], [2], [23], [24] and [25].

An example of fuel safety criteria set up for the evaluation of the fuel performance of the CNA-2 NPP is briefly quoted in Tab. 4, these criteria are highlighted in red. Reference is given to the document issued by UNIPI and related to “proposal for performing the ATUCHA II accident analyses for licensing purposes, Ref. [26], according with the international practice, Refs. [27] and [28].

The OECD/CSNI/PWG2 Task Force on Fuel Safety Criteria (TFFSC) performed a technically review of the existing fuel safety criteria, focusing on the ‘new design’ elements in 1999. The table reported below (Tab. 3) is an outcome of this working group. The figure reports a list of 20 fuel safety criteria. Most of the criteria of the category “C” of the table are relevant for the severe transients such as LOCA and RIA.

In the framework of the OECD working group of fuel safety, it is under preparation a review of the above mentioned document, Ref. [27], to account for new phenomena that occur at high burnup fuel.

4.3 Overview of best estimate approach developed at UNIPI

Based on qualified tools and analytical procedures developed or available at UNIPI, a modern and technically consistent approach has been built upon best estimate methods including an evaluation of the uncertainty in the calculated results (Best Estimate Plus Uncertainties or BEPU approach). The complete description of the approach, available in Refs. [27] and [29], is outside the aim of the present document. In the present section only specific notes will be provided relevant for addressing the role of the fuel pin performance tool in the framework of a chain of codes.

Adopting a “best estimate approach” for safety analyses means that, for each expected phenomenon, the best available tools and codes should be used. At present, no single code is capable of covering all phenomena involved in the nuclear safety field. Therefore, the best estimate analyst will meet the situation of working with two or more codes, and will have to develop an interface between those two as shown in Ref. [29].

In the overall approach, the role of the fuel behavior code, e.g. TRANSURANUS in the example, is used in connection with other codes, as outlined in Fig. 8 with the aim of investigating the behavior of the fuel and evaluate the performance.

4.4 Engineering handbook for fuel modelling

The creation of a fuel model for computer codes is an interactive procedure that includes the selection of specific models, material properties, appropriate BIC and eventually the modification of the source code e.g. for implementing specific models, preparation of the code input deck, and documentation of these activities. A key role is played by the possible interaction with other codes for providing the BIC, Ref. [31].

Depending on the objectives of the analysis e.g. run of chain of calculations or modeling of an experiment, the code input deck and the BIC, could be accident dependent. The documentation of all these steps, that can be called “*engineering handbook*”, it is developed in parallel with the development of the code input deck, the BIC preparation and the eventual source code modification. The handbook consists in a series of documents containing a full description and records of how the database has been converted into an input deck for the particular computer code, Fig. 9 and the implementation of the BIC. The documents should contain detail of:

- a) Methods, simplifying assumptions and calculations made to convert the technical fuel data to the necessary format for the input deck, an example can be found in Ref. [32].
- b) References to documents used for the preparation of the input, an example can be found in Ref. [32].
- c) All modeling assumptions made, adequately described and explained, an example can be found in Ref. [32].
- d) Assumptions made for BIC preparation (e.g. chain of codes or extrapolation of data from experimental database) and eventually description of code interactions an example can be found in Ref. [33][32].

e) Detailed description of code modifications and compilation, an example can be found in Ref. [34].

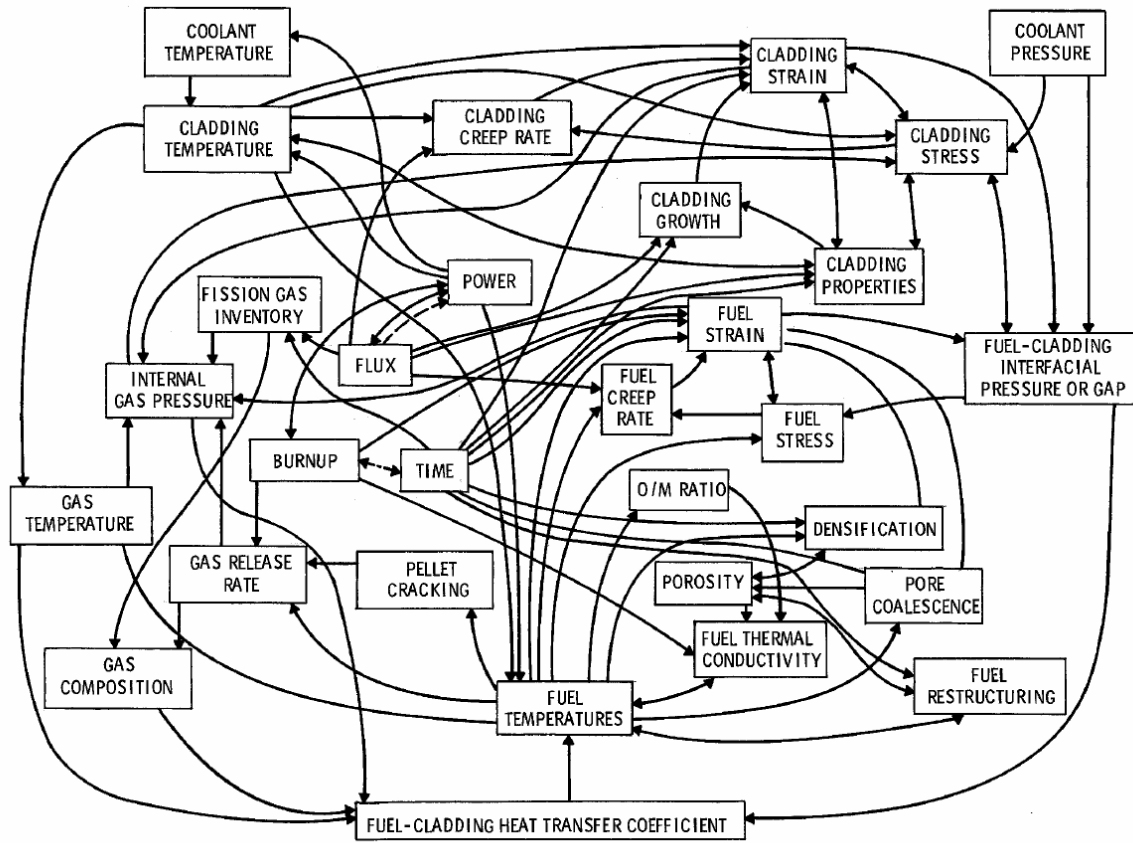
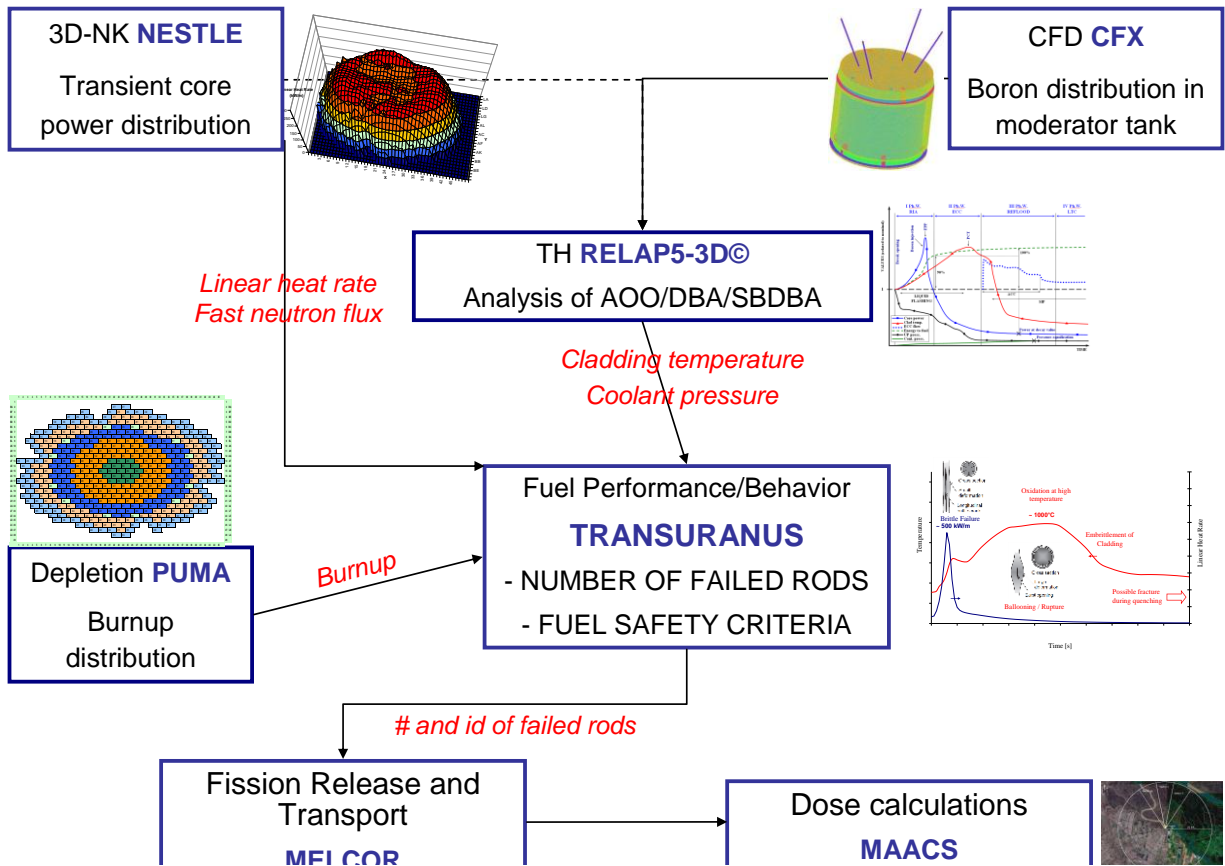

Fig. 7 – Parameters influencing the gap conductance according to G.R. Horn, quoted by Beyer et al. Ref. [30].



Appendix 1: Detail of the TRANSURANUS input deck

IP	Description of the IP	Value	Meaning of the value	Ref	Note
kanf	Identification of the beginning of data set/ Restart option	IDEN			
intrup	Control variable for the restart option	0	Standard calculation without restart		
nkomm	Number of text lines at the beginning of the data set	9			
pincha (1)	Pin characterisation: Reactor Type	HWR	Heavy Water Reactor	[6],[7]	
pincha (2)	Pin characterisation: Flux	THE	Thermal, epithermal and fast neutron spectrum (thermal reactor)	[6],[7]	
pincha (3)	Pin characterisation: Fuel Material	OXI	Oxide fuel	[6],[7]	
pincha (4)	Pin characterisation: Clad material	ZIR	Zircaloy cladding	[6],[7]	
ITEXTK(J)		Input test records ¹			
ITEXTK(J)		Input test records ¹			
ITEXTK(J)		Input test records ¹			
ITEXTK(J)		Input test records ¹			
ITEXTK (NKOMM-4)	Statistic file	cna2r1.sta			
ITEXTK (NKOMM-3)	Plot information file	cna2r1.pli			
ITEXTK (NKOMM-2)	Micro step file	cna2r1.mic			
ITEXTK (NKOMM-1)	Macro step file	cna2r1.mac			
ITEXTK	Restart file	cna2r1.ms			

Fig. 9 – Sample of the table used to document the input deck from Ref. [32].

Safety related criteria	Category	"New" elements affecting criteria	List of "new" design elements
(a) CPR/DNBR	A, B, C	1, 2, 5, 6, 7, 9	1. New fuel designs
(b) reactivity coefficient	B, C	2, 5, 6, 7, 8, 9	2. New core designs
(c) shutdown margin	A, B, C	1, 2, 5, 6, 7, 8, 11	3. New cladding materials
(d) enrichment	A, B, C	1, 2, 5	4. New manufacturing procedures
(e) crud deposition	A	1, 2, 3, 4, 5, 7, 10	5. Long fuel cycle
(f) strain level	A, B	1, 3, 4, 7, 8	6. Uprated power
(g) oxidation	A, B, C	3, 4, 7, 8, 10	7. High burnup
(h) hydride concentration	A, B, C	3, 4, 7, 8, 10	8. MOX
(i) internal gas pressure	A, B, C	1, 5, 6, 7, 8	9. Mixed core
(j) therm. - mech. loads	A, B	1, 3, 4, 7	10. Water chemistry changes
(k) PCI	A, B, C	1, 2, 3, 4, 6, 7, 8, 11	11. Current / new operating practices
(l) fuel fragmentation (RIA)	C	7, 8	
(m) fuel failure (RIA)	C	1, 3, 4, 7, 8	
(n) cladding embrittlement / PCT (non-LOCA run away oxidation)	C	3, 4, 7, 8	<u>Categories:</u>
(o) cladding embrittlement / oxidation	C	3, 4, 7, 8	A – normal operation
(p) blowdown / seismic loads	C	3, 7	B – anticipated transients
(q) assembly holddown force	A, B, C	1, 11	C – postulated accidents
(r) coolant activity	A, B, C	5, 6, 7, 8	
(s) gap activity	C	5, 6, 7, 8	
(t) source term	C	5, 6, 7, 8	

Tab. 3 – Fuel safety criteria from Ref. [27].

Safety Parameter	Criterion for the DBA
Fuel temperature	$T_{\max} < T_{\text{melt}}$ for 90% of pellet cross section at hot spot
Fuel enthalpy (for RIA)	Average fuel hot spot enthalpy < 230 cal/g for irradiated fuel
Heat transfer cladding/coolant	Departure from nucleate boiling (DNB) is admissible, except for the cases listed below under *
Clad temperature	$T_{\text{clad}} < 1200 \text{ }^{\circ}\text{C}$ except for the cases listed below under * when $T_{\text{clad}} < 650 \text{ }^{\circ}\text{C}$
Clad integrity (for LOCA)	Limited loss of integrity admissible Maximum local oxidation < 17%
Core-wide oxidation (for LOCA)	Maximum hydrogen generation $\text{H}_2 < 1\%$ of $\text{H}_{2\text{TOTAL}}$
Operation of PZR safety valves	Challenge admissible
RCS pressure	ASME Code Level C Service Limit ($p < 1.2 p_{\text{design}}$)
Secondary side pressure	ASME Code Level B Service Limit ($p < 1.2 p_{\text{design}}$)
Containment pressure	Maximum pressure < design pressure
Permissible dose	Calculated doses below limits 10CFR50.67 0.25 Sv total effective dose equivalent 0.05 Sv total effective dose equivalent for control room

* Examples of events with potential primary medium release outside the containment are:

- SG tube or moderator cooler tube rupture (with emergency mode)
- Long term loss of main heat sink with SG or moderator cooler tube leakage (equal to operational leakages)
- Main steam line rupture outside containment with SG or moderator tube leakage
- Break of an instrument line in the annulus.

Tab. 4 – Specific Acceptance Criteria for Design Basis Accidents from Ref. [26].

NORMAL OPERATION					
#	PARAMETERS FOR VALIDATION	EXP	EXP	EXP	PLANT
1	Burnup				
2	Cladding max creep down in BI				
3	Cladding corrosion and hydrogen content prior to ramps				
4	Cladding expansion during power ramp				
5	Grain size after ramp (pellet center/periphery)				
6	FGR after ramp				
7	Elongation after ramp				
8	Ridges height (avg. and max) in BI				
9	Ridges height (avg. and max) after ramp				
10	Clad ovality after ramp				
11	Inner cladding oxidation after ramp				
12	Failure / Not Failure				
13	Gap dimension				
14	Active fuel weight change				
15	Iodine burst test (crack dimension and stresses)				
<ul style="list-style-type: none"> ● suitable for code assessment ○ limited suitability – not suitable 		<ul style="list-style-type: none"> E Expected P Partially expected N Not expected 			

Tab. 5 – Normal operation: summary of relevant parameters for validation from Ref. [22].

LOCA					
#	PARAMETERS FOR VALIDATION	EXP	EXP	EXP	PLANT
1	Burnup				
2	Failure / Non-Failure				
3	Pressure trend during the test				
4	Time of failure				
5	Ballooning				
6	Gas flow				
7	Cladding strain				
8	Geometry changes				
9	Coolability				
10	Embrittlement				
11	α to β -phase transformation				
12	Oxidation				
13	Fuel fragmentation and relocation				
14	Fuel centerline temperature				
15	Cladding corrosion and hydrogen content at start of transient				
<ul style="list-style-type: none"> ● suitable for code assessment ○ limited suitability – not suitable 		<ul style="list-style-type: none"> E Expected P Partially expected N Not expected 			

Tab. 6 – Accident conditions: summary of relevant parameters for validation for the LOCA analysis from Ref. [22].

RIA					
#	PARAMETERS FOR VALIDATION	EXP	EXP	EXP	PLANT
1	Burnup				
2	Failure / Non-Failure				
3	Time of failure				
4	Peak fuel enthalpy				
5	Maximum enthalpy increase				
6	Pulse width (FWHM)				
7	Fission gas release				
8	Cladding corrosion and hydrogen content at start of transient				
<ul style="list-style-type: none"> ● suitable for code assessment ○ limited suitability – not suitable 		<ul style="list-style-type: none"> E Expected P Partially expected N Not expected 			

Tab. 7 – Accident conditions: summary of relevant parameters for validation for the RIA analysis from Ref. [22].

5 Severe transients: phenomena and process relevant to LOCA&RIA

Different phenomena involved in the heat-up, cooldown and quench may happen during a LOCA transient, due to the changes of the properties of the zirconium cladding alloys and the pellet which take place during the transient.

Typically a LOCA transient will start with the fuel under normal operating conditions. The cladding then has a temperature slightly above 300 °C. At the pellet cladding interface the temperature is about 400 °C with an approximately parabolic temperature distribution in the pellet. The center temperature in the pellet is perhaps 1200 - 2000 °C depending on the local power level. At the start of the LOCA the fissions quickly cease due to the loss of moderator and insertion of control rods. With the loss of coolant the cladding will start to heat up. The stored energy in the pellet redistributes towards a more flat radial temperature profile but heatup still will occur due the decay heat of the fuel. The initial heat-up of the cladding is mainly due to the redistribution of heat, the stored energy of the pellet, but in the longer term it is the decay heat which is responsible for the heating of the cladding, Ref. [2]. Schematic illustration of failure modes during LOCA transients is reported in Fig. 10.

The main safety concerns in reactivity initiated accidents are loss of long-term core coolability and possible damage to the reactor pressure boundary and the core through pressure wave generation, Ref. [1]. Fuel failure, i.e. loss of clad tube integrity, is in itself generally not considered a safety concern, since fuel failures do not necessarily imply loss of coolable geometry or generation of harmful pressure waves. Fig. 11 reports a schematic illustration of two types of failure modes in early and late phases of RIA transients. Nonetheless, RIA experiments and modeling have historically been focused on fuel rod failure, for several reasons:

- Fuel rod failure is a prerequisite for loss of coolable core geometry and pressure wave generation.
- The mechanisms for fuel rod failure are more easily studied, both experimentally and analytically, than those for gross core damage.
- Regulatory bodies require that the number of failed fuel rods in the core should be calculated in evaluations of radiological consequences to design basis RIA.

For the sake of completeness, Fig. 12 reports the scheme of the failure modes during combined LOCA and RIA, Ref. [22].

In an international study from 2001, a ranking of phenomena relevant during RIA was performed, Ref. [12].

From RIA simulation experiments in power pulse reactors, it has been found that the fuel rod behavior under a reactivity initiated accident is affected primarily by the:

- Characteristics of the power pulse, in particular the amplitude and pulse width.
- Core coolant conditions, i.e. the coolant pressure, temperature and flow rate.
- Burnup-dependent state of the fuel rod. Among the most important properties are the pre-accident width of the pellet-clad gap, the degree of cladding waterside corrosion, the internal gas overpressure in the fuel rod, and the distribution of gaseous fission products in the fuel pellets.

- Fuel rod design. Parameters of particular importance are the internal fill gas pressure, clad tube wall thickness, fuel pellet composition (UO₂/PuO₂/Gd₂O₃, enrichment) and the fuel pellet geometrical design (solid/annular).

Fig. 13 reports the possible mechanisms for fuel and cladding damage under a RIA Ref. [17].

5.1 Heat transfer

In general three regimes must be covered in a LWR:

1. The sub-cooled regime, where only surface boiling occurs. This regime is typical for PWR's under normal operating conditions.
2. The saturated, two phase regime. This regime is typical for BWR's under normal operating conditions.
3. The saturated or overheated regime. This regime may be reached in all off-normal situations. A typical example is a LOCA.

The fuel rod performance codes use one-dimensional (axial) fluid dynamic equations that can only cope with the first two regimes. For simulating the third type of regime, the whole reactor coolant system needs to be analyzed by means of thermo-hydraulic system codes, Refs. [35] and [36].

5.2 Burnup

The thermal and mechanical behavior of a fuel rod depends strongly on complex phenomena that vary with burnup, e.g. heat conduction, local porosity, fission gas release, as well as creep of fuel and cladding, Ref. [37]. Therefore, one of the first steps in describing fuel rod behavior is to calculate at each fuel position

- the fraction of fissile material burnt (local burnup),
- the conversion of ²³⁸U to ²³⁹Pu and the subsequent buildup and fission of the higher Pu isotopes, and
- the buildup of fission products.

The radial distributions of the fissile material determine:

- the radial power density distribution and hence the source term for the temperature calculations;
- the radial burnup distribution from which the local concentrations of fission products such as Kr, Xe, Cs and Nd are obtained.

The equations used to describe the above phenomena constitute the so-called burnup models. Burnup is usually quoted as rod average burnup or as average burnup of a specific section of the fuel rod. Regards the phenomena and processes that are affecting the fuel response to the LOCA and RIA transients, as related to the safety criteria, the following considerations can be drawn.

In LOCA, with respect to PCT, the burn-up affects the fuel/cladding temperature due to heat up, in that normally the fuel operating power in normal operation decreases with burn-up due to fuel depletion, and thus also the residual heat during the transient heat up is reduced. Hence the neutron flux and fuel power distribution in the core (calculated by core physics codes) as affected by burn-up are very important. The build-up of Plutonium is also important for

calculating (operating power during normal operation and) heat up in the transient. I am not convinced that the fissile radial distribution as such is so very important, but since it is part of the overall fissile consumption-build up, in this sense it is important.

In LOCA, with respect to ECR, if ECR is the metal wall reduction due to oxidation during the transient only, then there is nothing to add to what said above, i.e. that burnup affects the heat-up rate and hence cladding temperature, which in turn affects ECR. However, in some countries, such as for instance USA, the ECR is considered as the sum of the metal reduction due to corrosion during base irradiation and the oxidation during the transient. In such a case, burnup has an important influence via corrosion, in that the larger the base irradiation corrosion, the smaller will be the allowable ECR during the transient (and hence the allowable cladding temperature will also be reduced).

In RIA, with the use of a fixed limit of 230 cal/g, i.e. a value which is burn-up independent, the burn-up would play a positive role, again because the reactivity of the fuel normally decreases with burn-up, due to the decrease of fissile content. Again, core neutron calculations are important for calculating the fissile content and hence the deposited enthalpy in case of RIA. We do know however that a burnup independent criterion of 230 cal/g is totally unrealistic, although many countries still maintain it.

5.3 Failure

The LOCA-specific failure criteria are essential to model the behavior of the fuel rod during severe transient conditions (i.e. LOCA and RIA), which is one of the objectives of the analysis. The cladding failure is generally predicted on the basis of a stress assessment, i.e. the comparison of the calculated tangential stress with a failure threshold implemented in the code. However, due to the significant uncertainty in computing the stress when the cladding deformation is large, a strain-based failure criterion is more appropriate for LOCA conditions, Ref. [35].

Up to now, specific failure criteria for RIA should be investigated further from both experimental and modeling point of view. An example of Japanese limit for fuel failure threshold due to PCMI during RIA accidents is reported in Fig. 14.

5.4 Gas flow

The gas transport from the plenum to the ballooning-burst position is important for sustaining the ballooning and the fuel ejection after burst.

Axial gas flow in a fuel rod during a LOCA is a complicated function of the pre-transient state of the fuel (burnup, irradiation history) and the course of the transient itself where fuel and cladding are heated-up differently and exhibit a differential thermal expansion. The axial gas flow, even if limited by the closed gap between pellets and cladding, could obviously affect the pellet relocation process (as an additional driving force). This driving force is important and influences the timing of relocation as well as the amount of relocated fuel. Conservatively, it can be assumed that due to this force the relocation takes place right after cladding burst and that the total mass of fragments in the ballooned area is equal to the volume of the ballooned section multiplied by fuel density.

The influence of gas flow on fuel behaviour during LOCA is not well known. This requires the availability of specific experimental investigations, Refs. [1], [2] and [38].

5.5 Anisotropy of the cladding

An important parameter to account for LOCA analysis is the anisotropy of the cladding. The zirconium alloys are very anisotropic when they are in the hexagonal α -phase condition. LOCA specific values are used for the analysis.

The anisotropy plays an important role in case of non-uniform temperature distribution along the fuel rod, since it may cause the bending of the fuel rod and impairs the coolability, Ref. [1].

5.6 Oxidation

The effect of the outer cladding corrosion is twofold. Firstly, the corrosion layer may increase the thermal resistance of the cladding (thermal effect) and secondly, corrosion means that the cladding thickness of the original material decreases (mechanical effect).

The breakaway oxidation, which occurs at specific temperature ranges, is identified as a major problem for the cladding LOCA performance, since it is associated with a significant hydrogen pickup, which degrades post-quench properties. Therefore, careful examinations are required also for advanced high corrosion-resistance cladding alloys to examine the temperature-time range where the breakaway oxidation occurs.

5.7 Fuel fragmentation and relocation

Oxide fuel cracks into many pieces during normal operation. In a LOCA transient, temperature changes within a few seconds in parallel to radial temperature redistributions in the pellet of several hundreds of °C. This induces enough temperature stresses to promote fragmentation.

The consequences of cracking are important in fuel performance modeling. Owing to the larger thermal expansion of the fuel fragments in comparison with that of a monolithic cylinder, and due to vibration-induced motion they move outwards. This is called pellet “relocation” and has a strong impact on the thermal behavior. It reduces the pellet-cladding gap size, thereby reducing the temperature levels in the fuel at beginning-of-life. This constitutes the largest contribution to gap closure but it is also subjected to the largest uncertainty, because of stochastic nature of the cracking process. This also raises questions about the usefulness of applying 3D stress calculations. The contribution from relocation is generally accounted for in the tangential strain.

The mechanism for relocation needs to be better characterized as related to its occurrence during the ballooning phase or after the cladding burst. The slumping of fuel fragments may involve a significant amount of fuel, with partial relocation in the ballooned region and partial dispersal outside the cladding.

The relocation of fuel fragments into the balloon and fuel dispersal have several consequences Refs. [1], [2] and [38].

- Change of power profile. Fuel accumulating in the balloon will create a local power peak.
- Release of fine pellet fragments through the burst opening.
- Possible accumulation of ejected fuel on grids or structures. If a significant amount of fuel is released into the assembly structure, this may impair the coolable geometry.

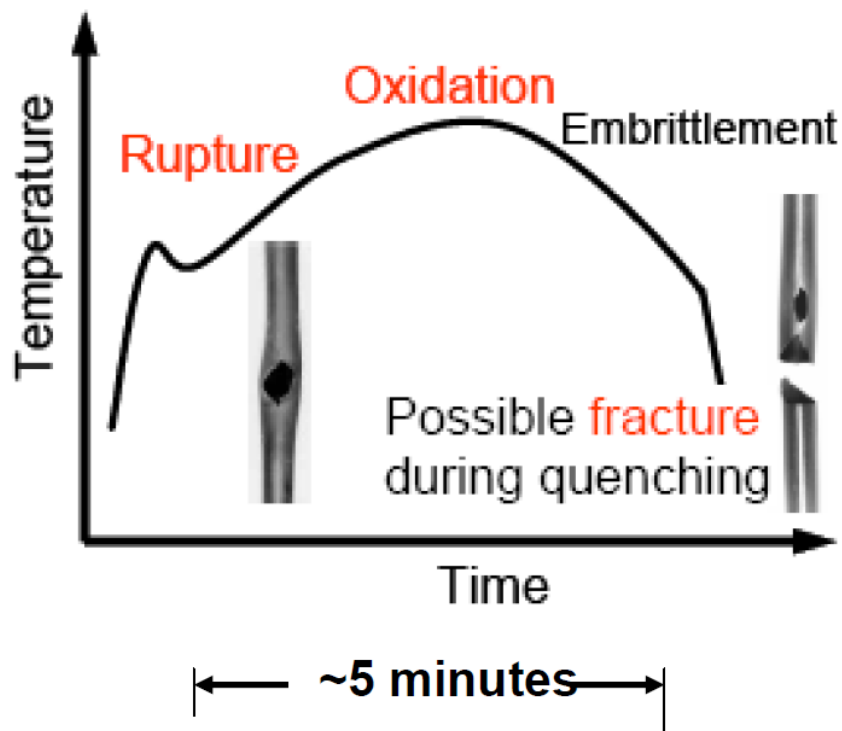

Fig. 10 – Schematic illustration of failure modes during LOCA transients, Ref. [18].

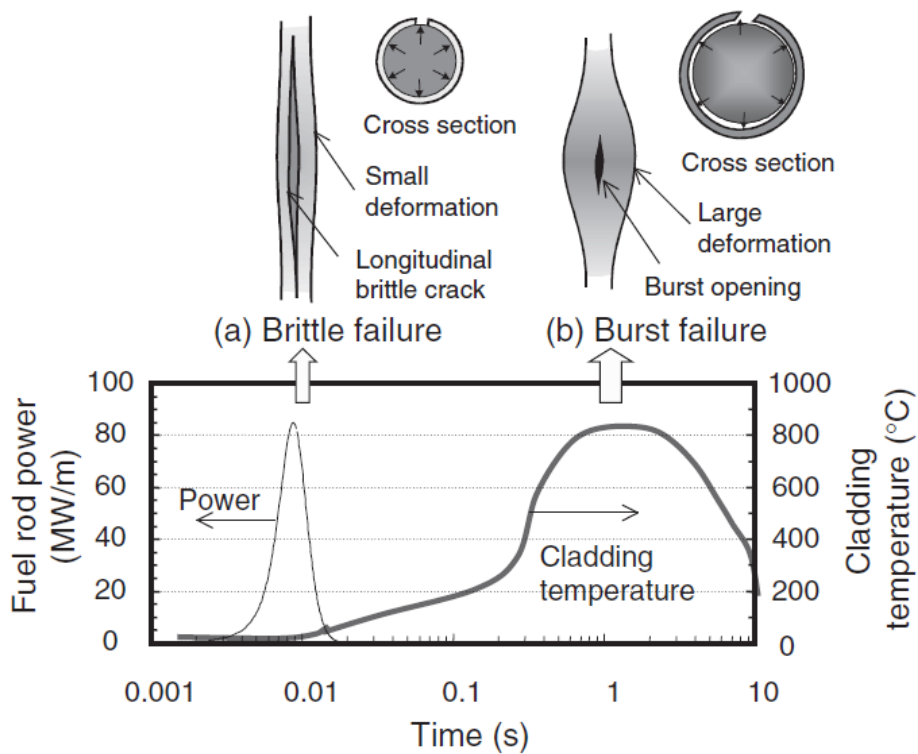

Fig. 11 – Schematic illustration of two types failure modes in early and late phases of RIA transients, Ref. [19].

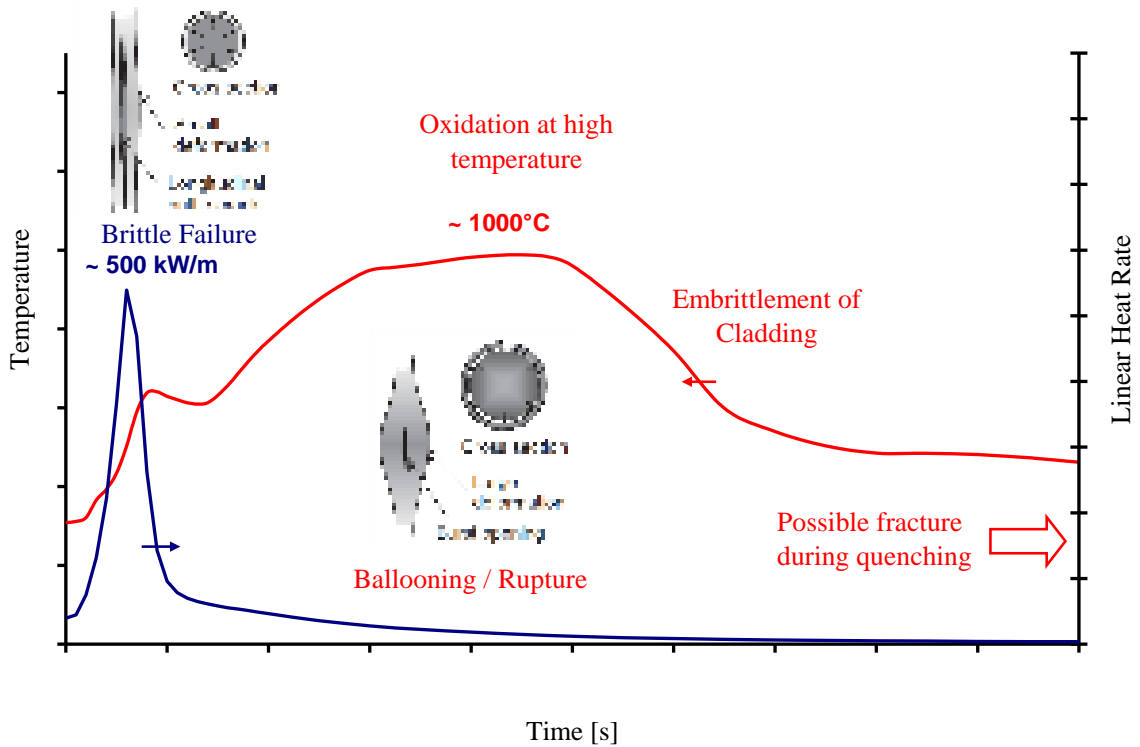

Fig. 12 – Scheme of failure modes during combined LOCA and RIA, Ref. [22].

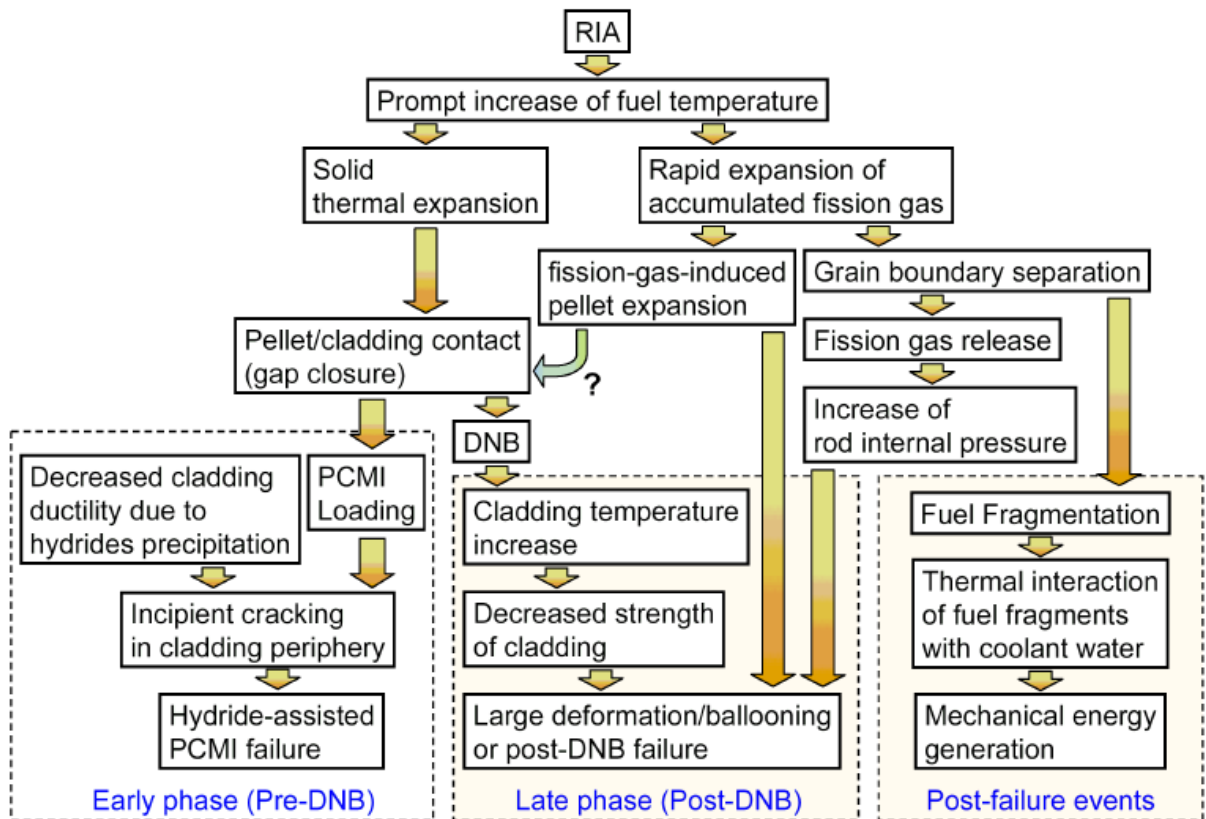

Fig. 13 – Possible mechanisms for fuel and cladding damage under a RIA, Ref.[17].

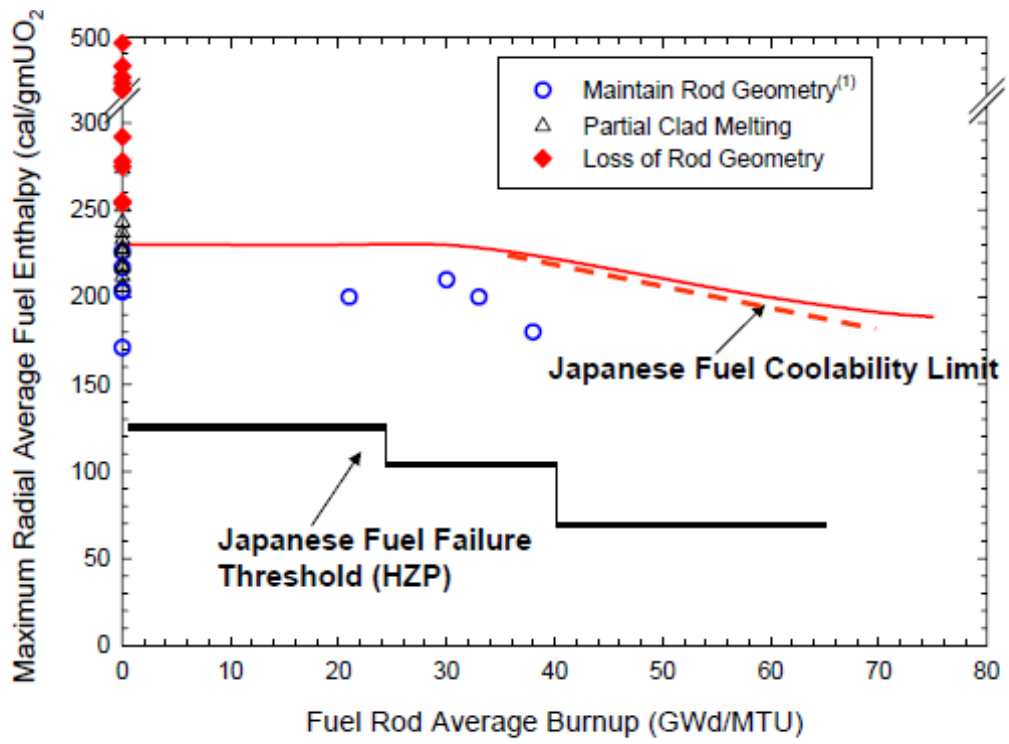

Fig. 14 – Example of Japanese fuel failure threshold for PCMI, Ref. [18].

6 Proposal for an experimental program of national interest

The existing safety criteria were established during the 1960s and 1970s and were verified against experiments with fuel available at that time, mostly unirradiated. In the last decades, a considerable world wide effort has been expended in experimental and numerical modeling of fuel rods behavior in accident conditions, which has led to a broader and deeper understanding of LOCA and RIA related phenomena.

With the advent of advanced fuel and core designs, the adoption of more aggressive operational modes and implementation of more accurate design and analysis methods, there is the concern over whether safety margins have remained adequate.

As a result of the worldwide trend to increase the fuel burnup and observing the microstructure changes and increased rates of cladding corrosion at higher burnup, a number of test programs were initiated, both from experimental and analytical nature, to evaluate the effects of the higher burnup on fuel behavior, especially under RIA and LOCA conditions.

Related to this, also the ENEA, in a joint OECD-Halden Reactor Programme experiment in Norway in the years 2000–2005, designed and tested the IFA-652. The irradiation experiment was related to assess the basic behavior of yttria and calcia based inert matrix fuel under irradiation conditions similar to those in current LWRs, Refs. [39], [40].

It would be interesting to investigate the behavior of such a fuel during accident conditions like LOCA and RIA. In this framework, Tab. 8 outlines a proposal for an experimental program to be conducted in the Halden Reactor. The table summarizes also the proposed time schedule for the project, distinguishing from different phases. The scheduled overall project duration is 36 months.

From the starting of the project, 3 months are needed to design the instrumented fuel rods and the test rig and the corresponding pressure flask. The mock-up and prototype for test rig will be performed in parallel.

After 14 months, the 3 instrumented fuel rods will be ready for irradiation (1 as backup).

The remaining 3 rods (1 as backup), the test rig and pressure flask will be ready for irradiation 18 months after the starting of the project.

The first set of fuel rods will be shipped to Kjeller for PIE that will be completed after 30 months from the starting of the project. Finally, also the three remaining rods will be shipped to Kjeller, in order to have the complete set of PIE ready 36 months after the starting of the project.

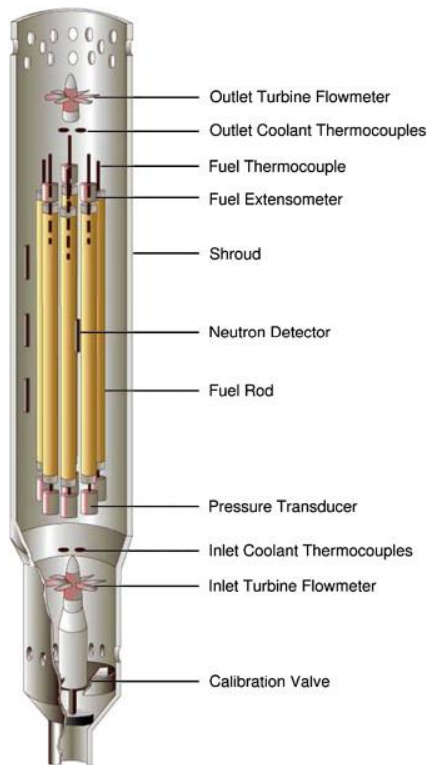

Fig. 15 – Schematic view of IFA-652 test-rig (test rig for burnup accumulation), Refs. [39], [40].

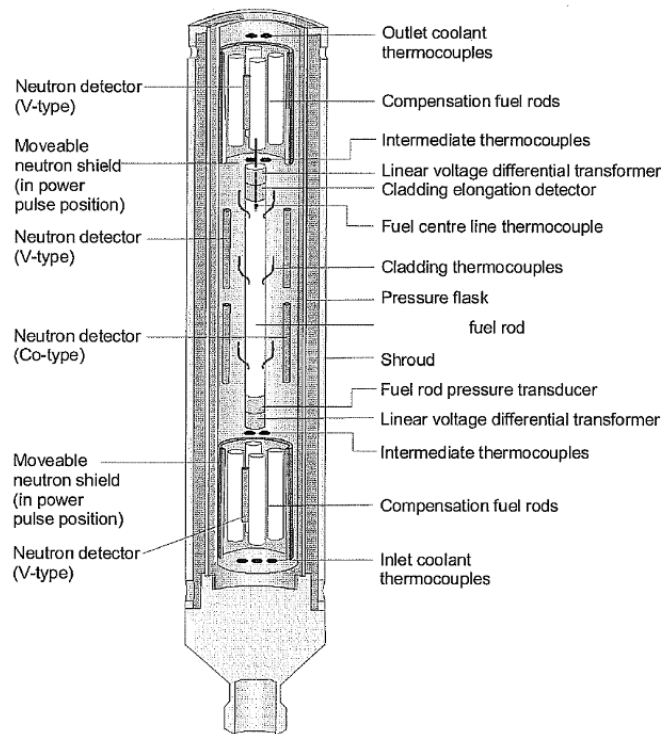

Fig. 16 – Test rig for transient testing layout, Ref. [22].

No	Id	Estimated months after the starting of the project			
1	Design Phase	0 - 3			
1.1	Design of the instrumented fuel rods	0 - 3			
1.2	Design of the test rig	0 - 3			
1.3	Design of the pressure flask	0 - 3			
2	Fabrication Phase	3 - 18			
2.1	Mock-up and prototype testing for test rig	0 - 3			
2.2	Fabrication of 3 instrumented fuel rods- Completed and ready for irradiation (1 as backup)		3 - 14		
2.3	Fabrication of test rig with pressure flask - Completed and ready for irradiation			14 - 18	
2.4	Fabrication of 3 instrumented fuel rods- Completed and ready for irradiation (1 as backup)			14 - 18	
3	Test Phase				18 - 33
3.1	Testing of the 2 un-irradiated fuel rods (one reactor cycle needed to complete these tests) - 3 months needed 1 test of LOCA and 1 test of RIA				18 - 21
3.2	Testing of the 2 irradiated fuel rods (one reactor cycle needed to complete these tests) - 3 months needed 1 test of LOCA and 1 test of RIA				30 - 33
4	PIE				21 - 36
4.1	PIE of the 2 un-irradiated fuel rods (starting 3 months after irradiation, estimated duration: 3-5 months)				21 - 30
4.2	PIE of the 2 irradiated fuel rods (estimated duration: 3-5 months)				33 - 36

Tab. 8 – Proposed time schedule of the project.

7 Conclusions

Phenomena involved during heat-up, cooldown and quench during a LOCA scenario are very complex and comes from the changes of properties of the zirconium cladding alloys which take place during the transient. Furthermore, main safety concerns in RIA scenario, such as loss of long-term core coolability and possible damage to the reactor pressure boundary and the core through pressure wave generation should be accounted for as well.

To perform such testing, there is the need to perform experiments beyond cladding failures. A small percentage of the research reactors in operation are suitable to perform experiments beyond cladding failure. The Halden research reactor resulted suitable to perform such experiment.

The national interest in the experiments, should be in the possibility to improve the knowledge on the consequences of severe transients on the fuel rods, such as power and/or temperature excursions to the fuel integrity, addressing:

- the failure limits;
- the failure mechanism and associated phenomena.

The experiment should provide also suitable data for modeling.

A proposal for an experimental program of national interest is outlined in the document. The proposed time schedule is inserted as well just to provide rough information about the timing needed to develop such a program.

References

- [1] OECD
Nuclear Fuel Behavior under Reactivity-Initiated Accident (RIA), State-of-the-art Report
NEA No. 6847, NEA/CSNI/R(2010)1, 2010.
- [2] OECD
Nuclear Fuel Behavior in Loss-of-coolant Accident (LOCA) Conditions, State-of-the-art Report
NEA No. 6846, 2009.
- [3] Vitanza C.
A review and interpretation of RIA experiments
Korea, 2008
- [4] Vitanza C.
Overview of the OECD–Halden reactor project
Nuclear Engineering and Design, Volume 207, Issue 2, Pages 207-221, July 2001.
- [5] Wiesenack W., Tverberg T.
The OECD Halden reactor project fuels testing programme: methods, selected results and plans
Nuclear Engineering and Design, Volume 207, Issue 2, July 2001, Pages 189-197.
- [6] Wiesenack W.
Review of Halden reactor project high burnup fuel data that can be used in safety analyses
Nuclear Engineering and Design, Volume 172, Issues 1-2, 3 July 1997, Pages 83-92.
- [7] Wiesenack W., T. Tverberg
The OECD Halden reactor project fuels testing programme: methods, selected results and plans
Nuclear Engineering and Design, Volume 207, Issue 2, July 2001, Pages 189-197.
- [8] Karlsen T. M.
Achievements and further plans for the OECD Halden reactor project materials programme
Nuclear Engineering and Design, Volume 207, Issue 2, July 2001, Pages 199-206.
- [9] OECD
OECD/NEA Halden Reactor Project
NEA website: <http://www.oecd-nea.org/jointproj/halden.html>.
- [10] IFE
Halden boiling water reactor
Institutt for energiteknikk, OECD Halden Reactor Project, Halden, January 2003.
- [11] Vitanza C.
Overview of the OECD-Halden Reactor Project
Nuclear Engineering and Design, Volume 2007, Issue 2, pp. 207-221, July 2001.
- [12] Boyack, B. E., et al.
Phenomenon Identification and Ranking Tables (PIRTs) for Loss-of-Coolant Accidents in Pressurized and Boiling Water Reactors Containing High Burnup Fuel
Los Alamos National Laboratory, U.S. Nuclear Regulatory Commission, NUREG/CR-6744, LA-UR-00-5079, December 2001.
- [13] Adorni M., A. Del Nevo, F. D’Auria, O. Mazzantini
A procedure to address the fuel rod failures during LB-LOCA transient in Atucha-2 NPP
Science and Technology of Nuclear Installations, Article ID 929358, doi:10.1155/2011/929358, 2011.

- [14]Adorni M, D. Rozzia, Del Nevo A., D'Auria F.
Modeling LB-LOCA: in Reactor Fuel Bundle Materials Test MT-4 and MT-6A
Software Licensing Agreement Ref. No. 30645, ITU and UNIPI – University of Pisa Report, FUEL/ITU31263/01(10) Rev. 1, December 2010.
- [15]Adorni M., Rozzia D., Del Nevo A., D'Auria F.
Investigation of PCI phenomenon in PWR fuel with TRANSURANUS code
IAEA Technical Meeting on Safety Issues related to the Use of High-burnup Fuel and to the Long Residence Time of Fuel in the Reactor, Vienna, Austria, 1-4 December 2009.
- [16]Adorni M., Del Nevo A., D'Auria F., Luzzi L.
Verification of TRANSURANUS code versions “v1m1j07” and “v1m1j08” against BWR-Inter-Ramp experiments
Software Licensing Agreement Ref. No. 30645, ITU and UNIPI – University of Pisa Report, DIMNP NT631(08)Rev.2, December 2008.
- [17]Fuketa, T., F. Nagase, and T. Sugiyama
RIA- and LOCA-simulating experiments on high burnup LWR fuels
IAEA technical meeting on fuel behaviour modelling under normal, transient and accident conditions and high burnups, Kendal, United Kingdom, September 5-8, 2005.
- [18]Vitanza C.
Fuel safety limits, with particular reference to high burnu-up
Thicket 2008.
- [19]Nakamura, T, et al.
High-Burnup BWR Fuel Behavior Under Simulated Reactivity-Initiated Accident Conditions
Nuclear Technology, Volume 138, No. 3, pp. 246-259, June 2002.
- [20]Nakamura, T, et al.
High-Burnup BWR Fuel Behavior Under Simulated Reactivity-Initiated Accident Conditions
Nuclear Technology, Volume 138, No. 3, pp. 246-259, June 2002.
- [21]Nakamura, T, et al.
Boiling Water Reactor Fuel Behavior Under Reactivity-Initiated-Accident Conditions at Burnup of 41 to 45 GWd/tonne U
Nuclear Technology, Volume 129, pp. 141-151, February 2000.
- [22]Adorni M.
Methodology for the Analysis of Fuel Behavior During LOCA and RIA
PhD Thesis in Nuclear Engineering, Department of Mechanics, Nuclear and Production Engineering, University of Pisa, Pisa (I), June 10, 2011.
- [23]OECD
Review of Nuclear Fuel Experimental Data
Fuel Behavior Data Available from IFE-OECD Haldekn Project, January 1995.
- [24]OECD
Scientific Issues in Fuel Behavior
NEA/Nuclear Science Committee Task Force, January 1995.
- [25]OECD
Review of high burn-up RIA and LOCA database and criteria
NEA/CSNI/R(2006)5, 2006.
- [26]UNIPI-GRNSPG
A proposal for performing the ATUCHA II accident analyses for licensing purposes
Contract NA-SA UNIPI 01 - Atucha II, University of Pisa Report, DIMNP NT (08) – rev3, Pisa, August 2008.

- [27]OECD
Fuel Safety Criteria Technical Review
Task Force on Fuel Safety Criteria, NEA/CSNI/R(99)25, 2000.
- [28]European Commission
Fuel cladding failure criteria
European Commission, EUR 19256EN, September 1999.
- [29]D'Auria F., Mazzantini O., Cherubini M., Giannotti W., Parisi C., Moretti F., Melideo D., Del Nevo A., Galassi G.M., Araneo D., Terzuoli F., Adorni M., Muellner N., Petruzzi A., Lazzerini D., Santoro R., Bousbia-Salah A.
DEGB LBLOCA (2 X 100% Break in CL) in Atucha-2 NPP.
Contract NA-SA UNIPI 01 - Atucha II, University of Pisa Report, DIMNP NT 628(08) - rev. 1, Pisa, March 2008.
- [30]Horn G.R., Babcock and Wilcox Company, Linchburg, VA (1973) quoted by C.E. Beyer, C.R. Hann, D.D. Lanning, F.E. Panisko, L. J. Parchen
GAPCON-THERMAL-2: A computer program for calculating the thermal behaviour of a fuel oxide fuel rod
BNWL-1898, NRC 1 and 3, 1975.
- [31]IAEA
Accident Analysis for Nuclear Power Plants
IAEA Safety Reports Series No 23, pp 1-121 Vienna (A), 2002.
- [32]Adorni M., A. Del Nevo, F. D'Auria
Development and set up of fuel pin model by TU code
Contract NA-SA UNIPI 02 - Atucha II, Pisa, Project task report FU-04 2008.
- [33]Adorni M., A. Del Nevo, F. D'Auria
Definition and implementation of the boundary and initial conditions for fuel pin analysis, LB-LOCA
Contract NA-SA UNIPI 02 - Atucha II, Pisa, Project task report FU-06 2008.
- [34]Adorni M., A. Del Nevo, F. D'Auria
Definition and implementation of the boundary and initial conditions for fuel pin analysis, Normal Operation
Contract NA-SA UNIPI 02 - Atucha II, Pisa, Project task report FU-09 2009.
- [35]Van Uffelen P., C. Gyori, A. Schubert, J. van de Laar, Z. Hózer, G. Spykman
Extending the application range of a fuel performance code from normal operating to design basis conditions
Journal of Nuclear Material, 383 137-14, 2008.
- [36]Van Uffelen P.
Modeling of Nuclear Fuel Behavior
Publications Office JRC Publications, Report EUR 22321 EN, European Commission, 2006.
- [37]Lassmann K., A. Schubert, P. Van Uffelen, Cs. Gyory, J. van de Laar
Transuranus Handbook Version "v1m1j09"
EC, JRC, ITU, January 2009.
- [38]OECD
Benchmark calculations on HALDEN IFA-650 LOCA test results
Nuclear Safety, NEA/CSNI/R(2010)65, 2010-65.
- [39]Hellwig et al., 2006 Ch. Hellwig, M. Streit, P. Blair, T. Tverberg, F.C. Klaassen, R.P.C. Schram, F. Vettraino and T. Yamashita
Inert matrix fuel behaviour in test irradiations
J. Nucl. Mater. 352 (2006), p. 291.
- [40]Streit et al., 2006 M. Streit, T. Tverberg, W. Wiesenack and F. Vettraino
Inert matrix and thoria fuel irradiation at an international research reactor,
J. Nucl. Mater. 352 (2006), p. 263.